



# ProCap<sup>®</sup> Manual Capsule Filler User Manual



We don't just sell machines—  
we provide service.

## Copyright Notice

© LFA Machines Oxford Limited, published in 2026 by LFA Machines Oxford Limited 2026. Registered in England and Wales, company number 08428898, registered office for service Demar House 14 Church Road East Wittering, Chichester, West Sussex, PO20 8PS.

All rights reserved. No part of this publication may be reproduced or transmitted, in any form or by any means, or stored in any retrieval system of any nature, without prior permission, except for fair dealing under the Copyright, Designs and Patents Act 1988, or in accordance with the terms of license issued by the Copyright Licensing Agency in respect of photocopying and/or reprographic reproduction. Application for permission for other use of the copyright material including permission to reproduce extracts in other published works shall be made to the publisher. Full acknowledgment of author, publisher and source must be given.

All trade marks are acknowledged and are owned by their respective owners.

## Important Safety Information

### READ THIS BEFORE OPERATING MACHINE

#### Intended Use

The intended use of this machine is to fill empty capsules with dry raw materials.

Potential misuse of this machine includes:

- Using any capsules that deviate from the standard two-piece design.
- Using softgel capsules.
- Using powders that could explode under pressure.
- Using wet or damp material.
- Cleaning the ProCap® Manual Capsule Filler with hot water, any corrosive liquid such as alcohol, or any heating appliance.

#### General Hazards

- Keep out of reach of children.
- Inspect manual capsule filler before use.
- Use this manual capsule filler only for its intended use as described in this manual.
- Do not modify the machine in any way.

#### Personal Protection

For personal protection while operating the ProCap® Manual Capsule Filler, abide by these actions:

- Avoid wearing loose jewelry to prevent entanglement.
- Contain long hair to prevent entanglement.
- Wear safety goggles.
- Wear disposable latex/rubber gloves.
- Wear a hairnet (food grade products only).
- Wear a beard net if needed (food grade products only).

# Important Safety Information

**READ THIS BEFORE OPERATING MACHINE**

## Symbols



### **WARNING**

This signals potential risk for personal injury.



### **CAUTION**

This signals potential risk for damage to the machine or other parts.

## Prop. 65 Statement for CA Residents

Based on LFA's current level of knowledge of our machines, the ProCap® Capsule Fillers do not require a Proposition 65 warning label.

## Warning for Explosive Material

This machine is not explosion proof. LFA recommends that you test your materials' explosivity before running them through this machine. If your materials are indeed explosive, do not use them with this machine.

# Table of Contents

<b>Copyright Notice</b>	<b>2</b>
<b>Important Safety Information</b>	<b>3</b>
Intended Use	3
Personal Protection	3
General Hazards	3
Symbols	4
Prop. 65 Statement for CA Residents	4
Warning for Explosive Material	4
<b>ProCap® Manual Capsule Filler Parts List</b>	<b>6</b>
<b>Preface</b>	<b>7</b>
<b>Training</b>	<b>8</b>
Off-Site Training	8
Training via Video Chat/Phone	8
LFA Articles	8
LFA Videos	8
<b>Installation</b>	<b>9</b>
Tools and Materials Needed	9
The Appropriate Workstation for the Machine	9
<b>Maintenance</b>	<b>18</b>
General Maintenance Prescriptions	18
Cleaning	18
<b>Troubleshooting</b>	<b>21</b>
Common Issues	21
Storing the ProCap® Manual Capsule Filler	22
<b>Appendix</b>	<b>23</b>
Glossary	23
Material of Contact Parts	23
Technical Specifications	24
Maintenance Checklist	24
Diagrams	25
Resources	26

# ProCap® Manual Capsule Filler Parts List

# Preface

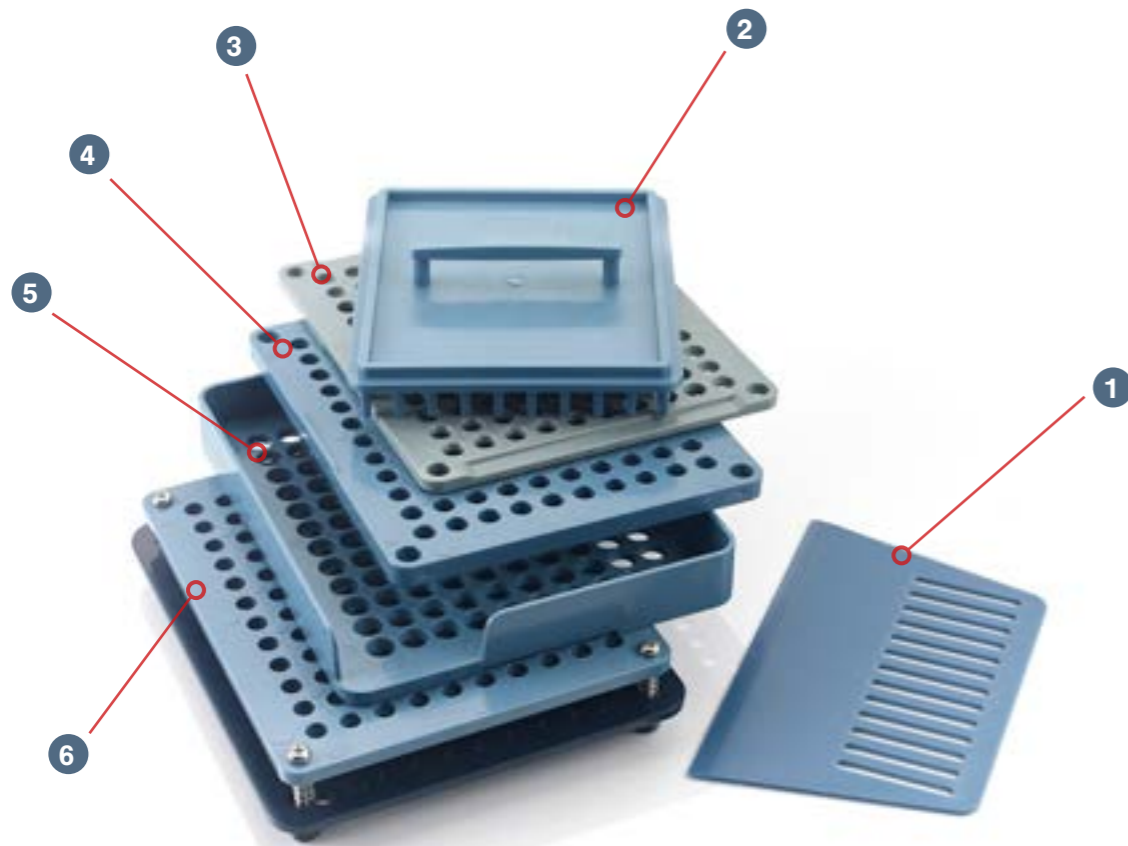

- 1. Powder Spreader**
- 2. Tamping Tool**
- 3. Middle Plate**

- 4. Cap Plate**
- 5. Alignment Plate**
- 6. Body Plate**

The ProCap® is a manual capsule filler that is able to create batches of 120 size #00 capsules at a time. Designed to produce consistent results and reduce waste due to its construction, the ProCap® is made from certified food grade BPA-free plastic and works with both vegetarian and gelatin capsules. The ProCap® is not only economical with no running costs, but also has the ability to test and craft just about any kind of powder-filled capsules,

The purpose of this document is to support your understanding of the ProCap® Manual Capsule Filler components, features, functions, and design. With this manual, you will be able to successfully operate and maintain your ProCap® Manual Capsule Filler.

The user manual's content includes:

- Important safety information
- ProCap® installation instructions
- Description of the ProCap®'s operation
- ProCap® maintenance information
- Appendix with supplemental information

# Training

Machine training can be beneficial for its successful operation and your personal safety. There are several methods to prepare you for working with your capsule filler.

## In-Person Training

LFA offers training at our UK, USA, and Taiwan facilities for all our customers and their teams. For more information, go to <https://www.lfacapsulefillers.com/services>

## Training via Video Chat/Phone

Using an online video chat system, an LFA technician can interact face-to-face with you and assist with your understanding of the machine. Or, if you prefer, LFA can provide training via phone for all customers who call the office. To set up a training, call or email your local LFA office:

**UK**  
**Phone**  
+44 01869 250234  
**Email**  
[support.uk@lfamachines.com](mailto:support.uk@lfamachines.com)

**USA**  
**Phone**  
(682) 312-0034  
**Email**  
[support.usa@lfamachines.com](mailto:support.usa@lfamachines.com)

**Taiwan**  
**Phone**  
+886 422031790  
**Email**  
[support.asia@lfamachines.com](mailto:support.asia@lfamachines.com)

## LFA Articles

LFA writes informative articles about our machines, which includes instructions, procedures, and guides. To access the articles, go to <https://www.lfacapsulefillers.com/articles>

## LFA Videos

LFA has created several videos involving our machines. To access the videos, go to <https://www.lfacapsulefillers.com/videos> or <https://www.youtube.com/user/TabletPilPress>

# Installation

## Tools and Materials Needed

Before you install and operate the ProCap® Manual Capsule Filler, it is best to have the following tools and materials on hand for general operation and maintenance:

- Scoop/spoon for capsules and powder
- Long wire pipe cleaner
- Toothbrush
- Cleaner (e.g. Member's Mark Commercial Lemon Fresh Disinfectant)
- Sanitizer (e.g. Member's Mark Commercial Sanitizer)
- Clean cloths
- Bagless vacuum
- Safety goggles
- Disposable latex/rubber gloves
- Hairnet and/or beard net (food grade products only)
- Sterile shoe covers (food grade products only)



## The Appropriate Workstation for the Machine

Find a clean, stable, and level workspace that securely supports the ProCap®.

### Environmental Conditions

It is important that the environment in which you operate and store the ProCap® Manual Capsule Filler has the appropriate temperature and relative humidity levels. These two environmental factors can potentially cause the machine to be damaged and/or cause the capsules to have a lower quality. The table below shows the acceptable temperature and relative humidity levels:

Machine	Temperature		Humidity
ProCap® Manual Capsule Filler	°C	°F	45-55% RH
	18-24	64-75	

The shipment will contain the following:

1. The ProCap® Manual Capsule Filler
2. Alignment plate
3. Powder spreader
4. Body plate
5. Middle plate
6. Cap plate
7. Tamping tool



### How to Create Capsules with the ProCap® Manual Capsule Filler

To watch a video on this process, go to <https://www.lfacapsulefillers.com/using-your-procap-capsule-filler>

#### Tools and Materials Needed

- Raw ingredients
- Empty separated capsules
- ProCap® Manual Capsule Filler and accessories
- Scoop/spoon for capsules and powder
- Receptacle for filled capsules
- Safety goggles
- Disposable latex/rubber gloves (for food grade products and to protect hands from grease)
- Hairnet and/or beard net (food grade products only)
- Sterile shoe covers (food grade products only)



**WARNING:** For personal protection while operating the ProCap® Manual Capsule Filler, contain long hair and do not wear loose jewelry.

#### Instructions

Note: Wear latex/rubber gloves (and appropriate food grade attire if applicable) during this process.

1. Place the alignment plate onto the body plate.

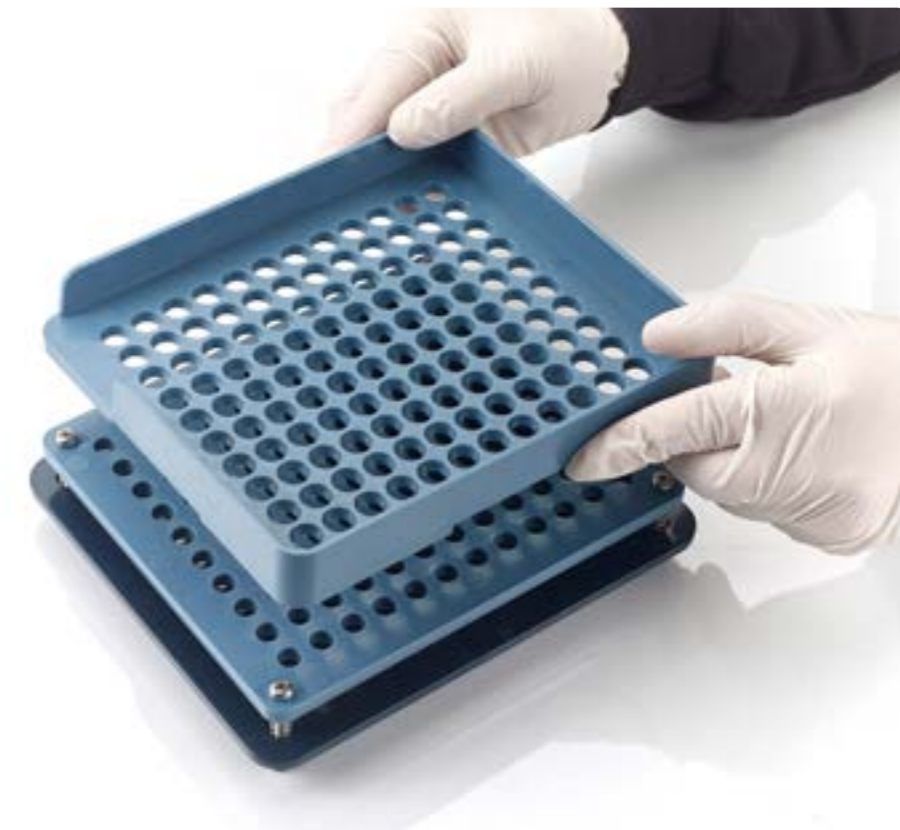

2. Pour the separated capsule bodies (120 count) on top of the alignment plate.



3. Shake the alignment plate and body plate so that the capsule bodies fall into the body plate.



4. Remove the alignment plate and slightly press down the body plate to ensure that all the holes have capsule bodies and that they are positioned correctly.

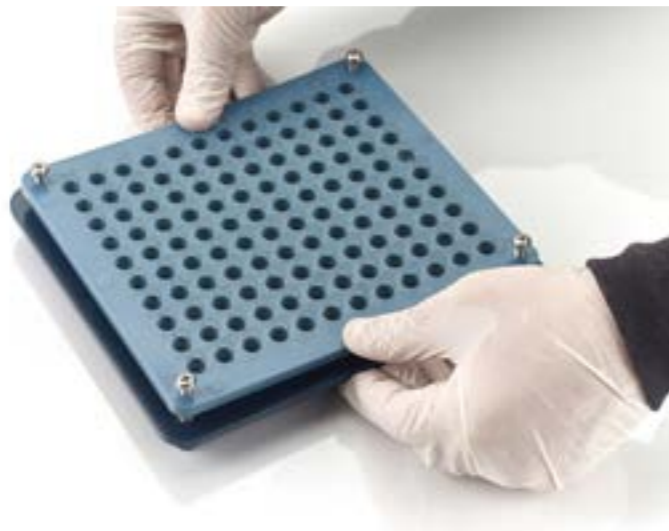

5. Place the alignment plate onto the cap plate.

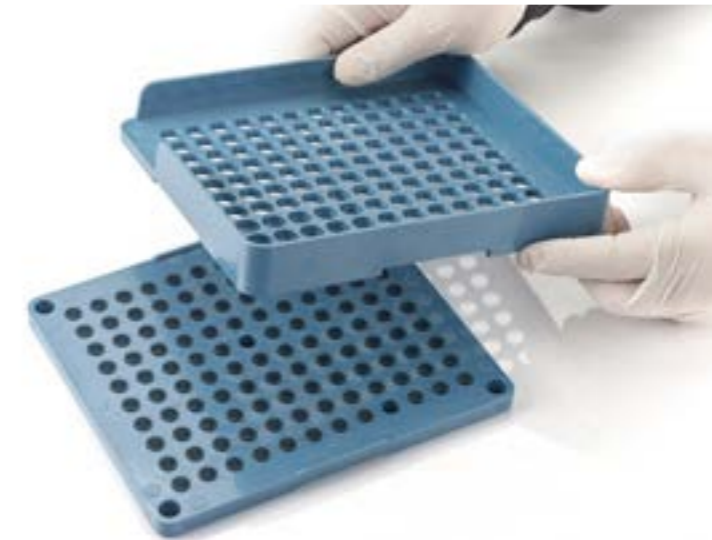

6. Pour the capsule caps (120 count) onto the alignment plate and shake the alignment plate and cap plate so that the capsule caps fall into the cap plate.



7. Remove the alignment plate from the cap plate and ensure that the capsule caps are in the correct position.



8. Pour the powder over the body plate with the capsule bodies.



9. Evenly distribute the powder into the capsule bodies with the powder spreader.

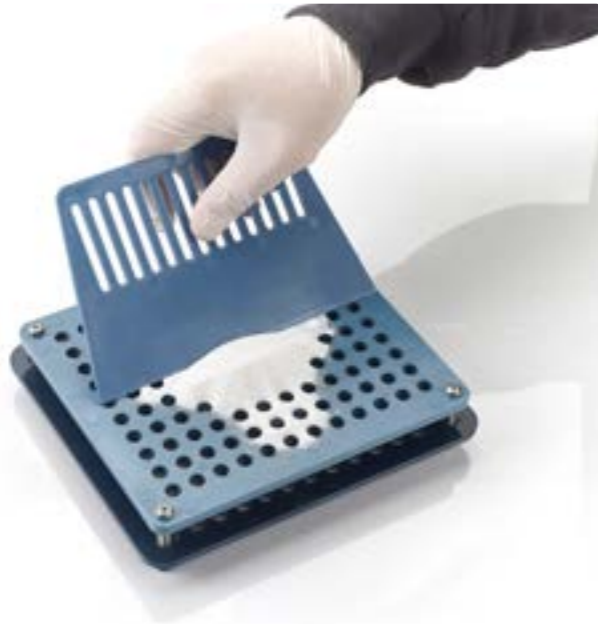

10. Gently compact the powder with the tamping tool.



11. Insert the middle plate onto the cap plate with the capsule caps.

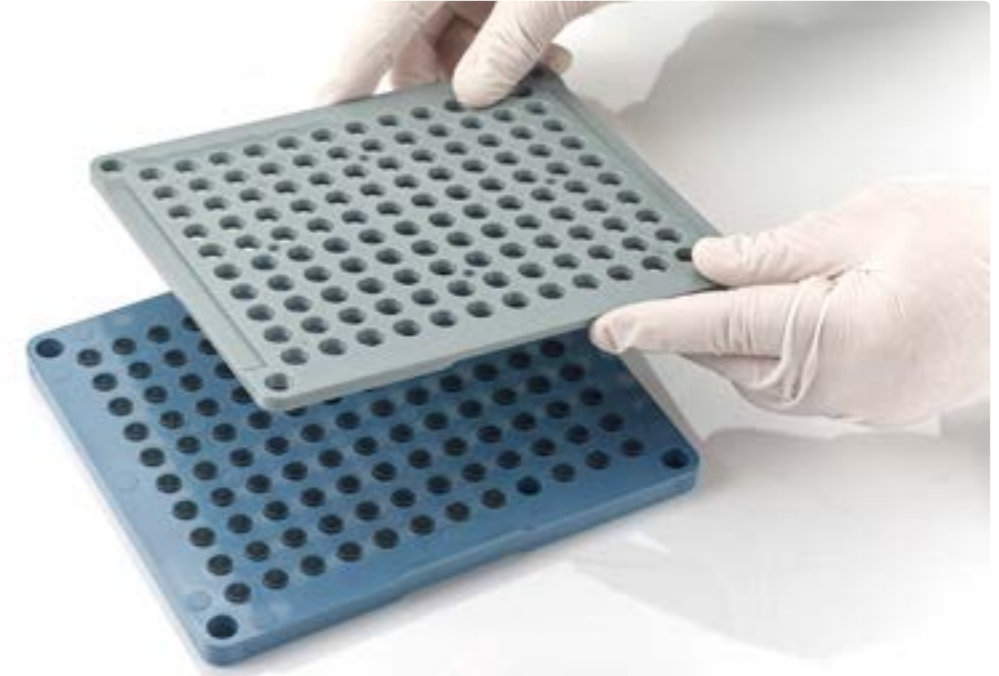

12. Turn over both the middle plate and cap plate 180 degrees and place them on the body plate.

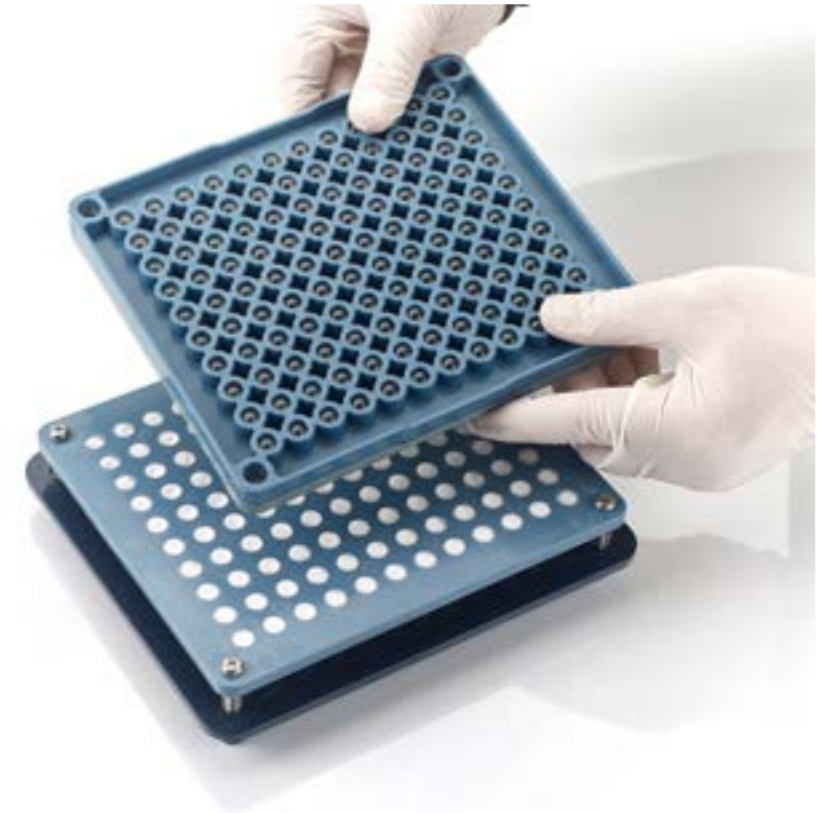

13. Push down all the plates together several times to seal the capsules.



14. Remove the cap plate and middle plate from the body plate.



15. Separate the cap plate and middle plate.



16. Remove the filled capsules from the cap plate.



# Maintenance

To ensure that the ProCap® Manual Capsule Filler will have a long operational life, maintenance is essential. This section includes methods for troubleshooting solutions and how often to clean your machine to keep its performance optimal.

## General Maintenance Prescriptions

- Use the maintenance checklist (found in the Appendix) before, during, and after machine operation.
- After cleaning the machine, make sure that the parts are dried.

## Cleaning

After the ProCap® Manual Capsule Filler's operation, powder may accumulate in the different plates and accessories. It is important to clean the ProCap® Manual Capsule Filler thoroughly to prevent rusting and cross contamination.

LFA recommends that the machine be cleaned after each operation.

### Tools and Materials Needed

- Bagless vacuum
- Long wire pipe cleaner
- Toothbrush
- Cleaner (e.g. Member's Mark Commercial Lemon Fresh Disinfectant)
- Sanitizer (e.g. Member's Mark Commercial Sanitizer)
- Potable water and clean cloths
- Disposable latex/rubber gloves
- Hairnet and/or beard net (food grade products only)
- Sterile shoe covers (food grade products only)



**CAUTION:** Do not clean the ProCap® with hot water, any corrosive liquid such as alcohol, or any heating appliance.

### Instructions

Note: Wear safety goggles and latex/rubber gloves (and appropriate food grade attire if applicable) during this process.

### Clean the ProCap® Manual Capsule Filler and Accessories

1. Separate all of the ProCap® plates.
2. Remove any excess powder from the ProCap® plates with a bagless vacuum.

3. Take one of the ProCap® plates and submerge it in the water.
4. Use a wire pipe cleaner and/or toothbrush to clean difficult-to-remove debris on the ProCap® plate.
5. Use the cleaner on the ProCap® plate, wash off the cleaner with water, and immediately dry the plate with a clean cloth.
5. Sanitize the plate with a clean cloth.
6. Repeat steps 3-5 for each one of the remaining ProCap® plates.



7. Submerge the tamping tool and the powder spreader in the water.
8. Use a wire pipe cleaner and/or toothbrush to clean difficult-to-remove debris on both accessories.
9. Use the cleaner on the tamping tool and the powder spreader, wash off the cleaner with water, and immediately dry the accessories with a clean cloth.
10. Sanitize each accessory with a clean cloth.



## Cleaning Schedule Matrix

Part	Frequency							
	After installing machine	After every use	Before every use	In between products that present a cross contamination risk	Weekly	Monthly	Before placing in storage	After removing from storage
Alignment Plate	Clean on machine	Remove from machine	Clean on machine	Remove from machine	N/A	N/A	Remove from machine	Install on machine
Powder Spreader	Clean on machine	Remove from machine	Clean on machine	Remove from machine	N/A	N/A	Remove from machine	Remove from machine
Body Plate	Clean on machine	Remove from machine	Clean on machine	Remove from machine	N/A	N/A	Remove from machine	Remove from machine
Middle Plate	Clean on machine	Remove from machine	Clean on machine	Remove from machine	N/A	N/A	Remove from machine	Remove from machine
Cap Plate	Clean on machine	Remove from machine	Clean on machine	Remove from machine	N/A	N/A	Remove from machine	Remove from machine
Tamping Tool	Clean on machine	Remove from machine	Clean on machine	Remove from machine	N/A	N/A	Remove from machine	Remove from machine

Cleaning Level Key	
Level 1 - Remove powder	
Level 2 - Dry clean with cloth	
Level 3 - Dry clean and re-lubricate if specified in lubrication schedule	
Level 4 - Wet clean and re-lubricate if specified in lubrication schedule	
Remove from machine - Take part out of machine and clean if required. Store it correctly or install back into machine.	
Install into machine - Install part into the machine and make sure that it has been cleaned. If needed, lubricate to the level required.	
Clean on/in machine - Clean the part while in the machine and do not remove it. Make sure that all contact surfaces are clean to the level required.	

This cleaning matrix is intended as a guide only and is not an exhaustive list. All cleaning schedules will need to be adapted to the industry and product, following industry regulations and the material safety data sheets that come with specific products. Please check with your Food Safety Manager/Department, Quality Control Manager/Department, or other relevant internal departments at your company before using.

# Troubleshooting

Sometimes unavoidable issues will occur while operating the ProCap® Manual Capsule Filler. Fortunately, there are several methods to remedy these issues.

## Common Issues

Symptom	Possible Cause	Possible Solution
Inconsistent capsule weights	The pins of the tamping tool are uneven.	Inspect the tamping plate for any damage and replace if needed.
	There is not enough powder.	Increase the powder and ensure that it is evenly distributed over the capsule bodies with the powder scraper.
Split capsules	There is too much powder being distributed.	Use less powder.
	The capsules have been exposed to moisture.	Improve capsule storage conditions.
Improperly closed capsules	There is damage to the body-cap interface (sealing area).	Replace the damaged capsules.
	The capsules are being overfilled.	Use less powder.
Dusty capsules	Capsules are not being polished.	Use a capsule polisher after filling capsules. Order one from LFA at <a href="https://www.lfacapsulefillers.com/cp7000-capsule-polisher">https://www.lfacapsulefillers.com/cp7000-capsule-polisher</a>

## Storing the ProCap® Manual Capsule Filler

After its thorough cleaning, the ProCap® Manual Capsule Filler needs to be stored in the proper conditions. It is important to store it in an environment in which the capsule filler is safe from being damaged or becoming dirty.

### Store the ProCap® Manual Capsule Filler

Place the ProCap® Manual Capsule Filler inside a clean container. You can use the box in which the ProCap® and its accessories were stored during delivery.



### Environmental Conditions

It is important that the environment in which you store the ProCap® has the appropriate temperature and relative humidity levels. These two environmental factors can potentially cause damage to the machine. The table below shows the acceptable temperature and relative humidity levels:

Machine	Temperature		Humidity
	°C	°F	
ProCap®	15-28	59-83	45-55% RH

## Appendix

### Glossary

Term	Definition
API/Active Pharmaceutical Ingredient	Any substance or mixture of substances used that is an active ingredient in the drug product.
Alignment Plate	ProCap® accessory that is used to load the capsule bodies and caps.
Body Plate	The part of the ProCap® that holds the capsule bodies.
Cap Plate	The part of the ProCap® that holds the capsule caps.
Excipient	An inactive substance that serves as the vehicle or medium for a drug or other API.
Formulation	Powder mix of the excipient and the API that is used to fill capsules.
Middle Plate	The part of the ProCap® that covers the cap plate so that the capsule caps can be turned over.
Powder Spreader	ProCap® accessory that is used to distribute powder into capsule bodies.
Tamping Tool	ProCap® accessory that is used to compact powder inside the capsule bodies.

### Material of Contact Parts

Contact Part	Material
ProCap® plates and Tamping Tool	PC+ABS
Powder Scraper	PP

## Technical Specifications

Procap® Dimensions	
Measurement	Value
Length	200 mm / 7.8 in
Width	170 mm / 6.7 in
Height	85 mm / 3.3 in
Weight	877 g / 1.9 lbs
In Box Dimensions	
Length	220 mm / 8.6 in
Width	195 mm / 7.6 in
Height	100 mm / 3.9 in
Weight	1220 g / 2.7 lbs

## Maintenance Checklist

Before Operation	
<input type="checkbox"/>	Visually inspect the capsule filler and the parts.
<input type="checkbox"/>	Operate the capsule filler with no capsules and powder to ensure it works properly.
During Operation	
<input type="checkbox"/>	Watch for buildup of powder in the ProCap®.
<input type="checkbox"/>	Weigh a sample capsule.
After Operation	
<input type="checkbox"/>	Remove all excess powder with a bagless vacuum.
<input type="checkbox"/>	Dismantle the ProCap® and clean all components and accessories.
<input type="checkbox"/>	Store the ProCap® in the box it was shipped in.

## Diagrams

### ProCap® Manual Capsule Filler Dimensions

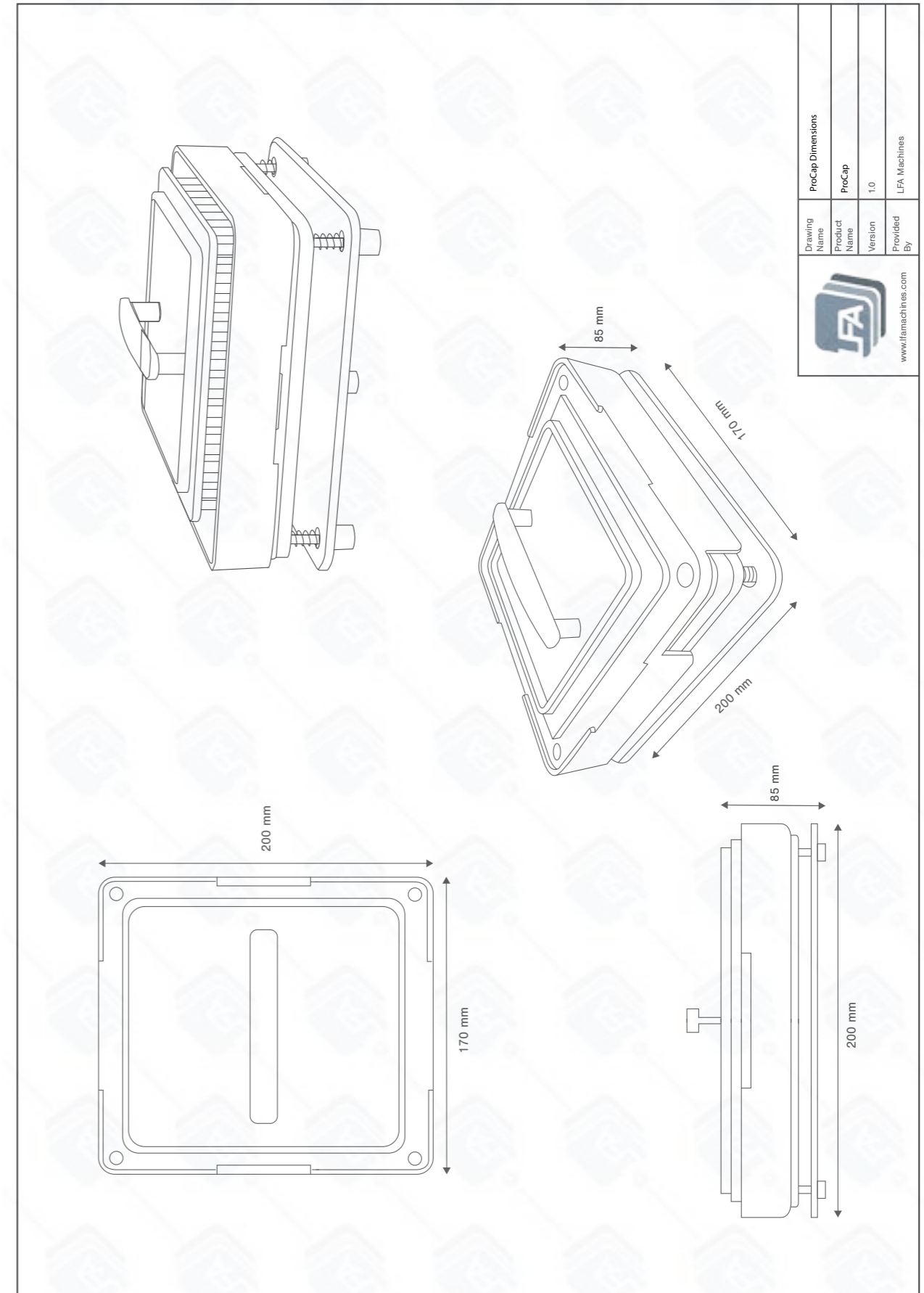

# Resources

## Helpful Links

### Warranty

For information regarding the warranty policy of the ProCap® Manual Capsule Filler and other LFA products, please visit <https://www.lfacapsulefillers.com/warranty>

### LFA Website

In order to aid you in your capsule production, LFA Machines maintains a website that offers a breadth of useful information about the ProCap® Manual Capsule Filler and other machines.

Visit the LFA homepage at <https://www.lfacapsulefillers.com/>

### LFA Machines YouTube Channel

Our YouTube videos provide you an opportunity to see how to use our machines, common troubleshooting tips, and other LFA products such as tablet presses and mixers. We regularly upload videos to give you a visual aid that will hopefully support you in your production efforts. To watch our videos, please visit <https://www.youtube.com/channel/UCwtbcwja77ai7vX2o34FUkQ>

### LFA Machines Social Media

Social media is a great way to keep yourself updated on new developments and exciting things happening at LFA Machines. The list below contains our current social media pages:

Twitter: @fatabletpress

Facebook: <https://www.facebook.com/fatabletpresses>

LinkedIn: <https://www.linkedin.com/company/lfa-machines-oxford-ltd/>



## Contact Us

### UK

LFA Machines Oxford Ltd  
Unit 4B Rowood Estate  
Murdock Road  
Bicester, Oxfordshire OX26 4PP  
+44 01869 250234  
[support.uk@lfamachines.com](mailto:support.uk@lfamachines.com)  
Monday-Friday  
9AM-5PM GMT

### USA

LFA Machines DFW, LLC  
6601 Will Rogers Blvd  
Fort Worth, TX 76140  
+1 (682) 312 0034  
[support.usa@lfamachines.com](mailto:support.usa@lfamachines.com)  
Monday-Friday  
8AM-6PM UTC (Central)

### Germany

LFA Machines Düsseldorf GmbH  
Business Parc Am Trippelsberg 92  
Düsseldorf, North-Rhine  
Westphalia 40589  
+41 21188250223  
[verkauf@lfamachines.com](mailto:verkauf@lfamachines.com)

### Taiwan

LFA Machines Taiwan Ltd  
7F-5, No. 2, Sec. 2 Taiwan Blvd  
West District, Taichung City 403  
Taiwan  
+886 422031790  
[support.asia@lfamachines.com](mailto:support.asia@lfamachines.com)  
Monday-Friday  
9AM-5PM GMT+8

Copyright © 2026 by LFA Machines

[www.lfamachines.com](http://www.lfamachines.com)

### United Kingdom

Unit 4B  
Murdock Road  
Bicester  
Oxfordshire  
United Kingdom  
OX26 4PP

### United States

6601 Will Rogers Blvd  
Fort Worth  
Texas  
United States  
76140

### Germany

Business Parc Am  
Trippelsberg 92  
Düsseldorf  
Germany  
40589

### Taiwan

7F-5, No. 2, Sec. 2  
Taiwan Blvd., West Dist.,  
Taichung City 403,  
Taiwan