



# FACF<sup>®</sup> Range Fully Automatic Capsule Filler User Manual



We don't just sell machines—  
we provide service.

# Copyright Notice

© LFA Machines Oxford Limited, published in 2020 by LFA Machines Oxford Limited 2020. Registered in England and Wales, company number 08428898, registered office for service Demar House 14 Church Road East Wittering, Chichester, West Sussex, PO20 8PS.

All rights reserved. No part of this publication may be reproduced or transmitted, in any form or by any means, or stored in any retrieval system of any nature, without prior permission, except for fair dealing under the Copyright, Designs and Patents Act 1988, or in accordance with the terms of license issued by the Copyright Licensing Agency in respect of photocopying and/or reprographic reproduction. Application for permission for other use of the copyright material including permission to reproduce extracts in other published works shall be made to the publisher. Full acknowledgment of author, publisher and source must be given.

All trade marks are acknowledged and are owned by their respective owners.

# Important Safety Information

## READ THIS BEFORE OPERATING MACHINE

### Intended Use

The intended use of this machine is to fill empty capsules with dry raw materials.

Potential misuse of this machine includes:

- Using any capsules that deviate from the standard two-piece design.
- Using softgel capsules.
- Using powders that could explode under pressure.
- Using wet or damp material.

### Personal Protection

For personal protection while transporting the FACF® range, abide by these actions:

- Use a pallet jack to lift the machine.
- Wear steel toe boots to prevent foot injury.
- Wear heavy duty grip gloves to ensure firm grasp on machine.
- Wear back support belt to prevent injury if needed.

For personal protection while operating the FACF® range, abide by these actions:

- Avoid wearing loose jewelry to prevent machine entanglement.
- Contain long hair to prevent machine entanglement.
- Wear safety goggles.
- Wear disposable latex/rubber gloves.
- Wear a hairnet (food grade products only).
- Wear a beard net if needed (food grade products only).

### General Hazards

**In the case of an emergency during operation, immediately push the Emergency Stop button.**

- Do not allow powder to collect at the Turret and Tamping Station.
- Be aware of risk of entanglement and pinch point due to moving parts.
- Do not operate in a wet environment or with wet hands due to risk of electrical shock or burn.
- Do not operate if any wires are exposed in cables due to risk of electrical shock or burn.
- Use extreme caution when servicing any electrical component.
- Keep out of reach from children.
- Keep fingers away from all moving parts.
- Inspect machine before use.
- Check that nuts and bolts are suitably tightened.
- Use this machine only for its intended use as described in this manual.
- Do not modify the machine in any way.
- Turn off and unplug the machine before conducting cleaning and maintenance.

# Important Safety Information

**READ THIS BEFORE OPERATING MACHINE**

## Symbols



### **WARNING**

This signals potential risk for personal injury.



### **WARNING**

This signals potential risk for electrical shock.



### **CAUTION**

This signals potential risk for damage to the machine or other parts.

## Modes for Stopping

In the case of an emergency during operation, immediately push the Emergency Stop button and unplug the FACF® range:





# Table of Contents

<b>Copyright Notice</b>	<b>2</b>
<b>Important Safety Information</b>	<b>3</b>
Intended Use	3
Personal Protection	3
General Hazards	3
<b>Important Safety Information</b>	<b>4</b>
Symbols	4
Modes for Stopping	4
<b>FACF® Range Components</b>	<b>6</b>
<b>Preface</b>	<b>7</b>
<b>Training</b>	<b>8</b>
On-Site/Off-Site Training	8
Training via Video Chat/Phone	8
LFA Articles	8
LFA Videos	8
<b>Installation</b>	<b>9</b>
Tools and Materials Needed	9
Positioning the FACF® Range	12
Controls	13
Settings and Adjustment	19
<b>Maintenance</b>	<b>35</b>
General Maintenance Prescriptions	35
Lubrication	35
Dismantling for Repair and Replacement	38
Wear Parts and Causes of Damage	39
<b>Troubleshooting</b>	<b>81</b>
Common Issues	81
Common Issues Continued	82
De-Jamming the FACF® Range	83
Cleaning	85
Storing the FACF® Range	88
<b>Appendix</b>	<b>89</b>
Glossary	89
Description of FACF® Range Parts	90
Food Grade Point of Contact Parts	92
Technical Specifications	92
Maintenance Checklist	93
Diagrams	94
Resources	110

# FACF<sup>®</sup> Range Components

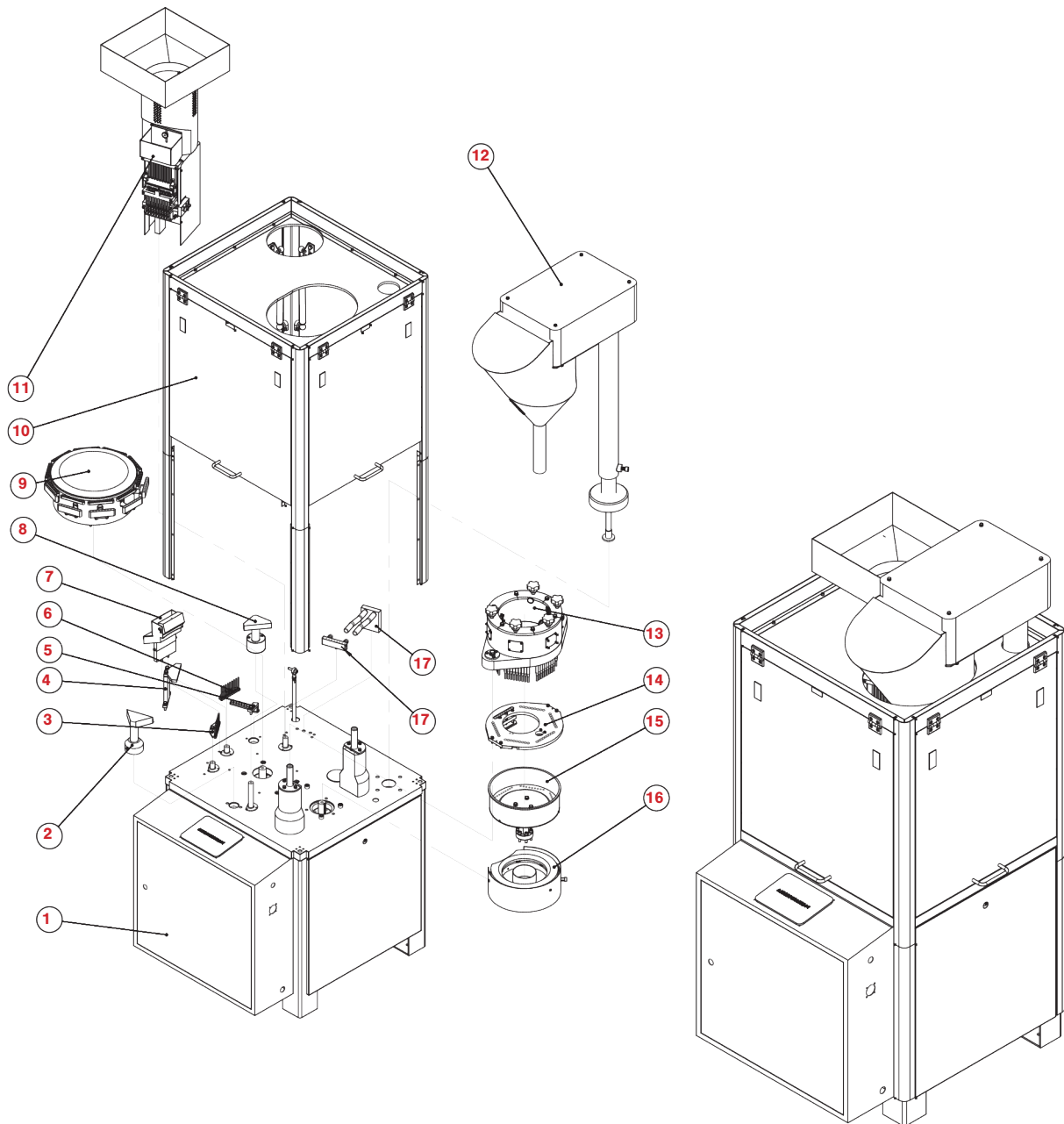

- 1. Electrical Cabinet
- 2. Vacuum Rejection Assembly
- 3. Capsule Closing Pins Assembly
- 4. Capsule Closing Plate Assembly
- 5. Unseparated Capsule Ejection
- 6. Capsule Ejections Pins
- 7. Capsule Ejection Chute
- 8. Vacuum Cleaning Assembly
- 9. Die Segment Turret
- 10. Outer Casing

- 11. Capsule Sewing Assembly
- 12. Powder Auger Assembly
- 13. Dosing Station Tamping Pins Assembly
- 14. Tamping Pins Guide Runner
- 15. Tamping Bowl/Dosing Disc
- 16. Dosing Station Lower Assembly
- 17. Vacuum Manifold and Vacuum Plate Composition

# Preface

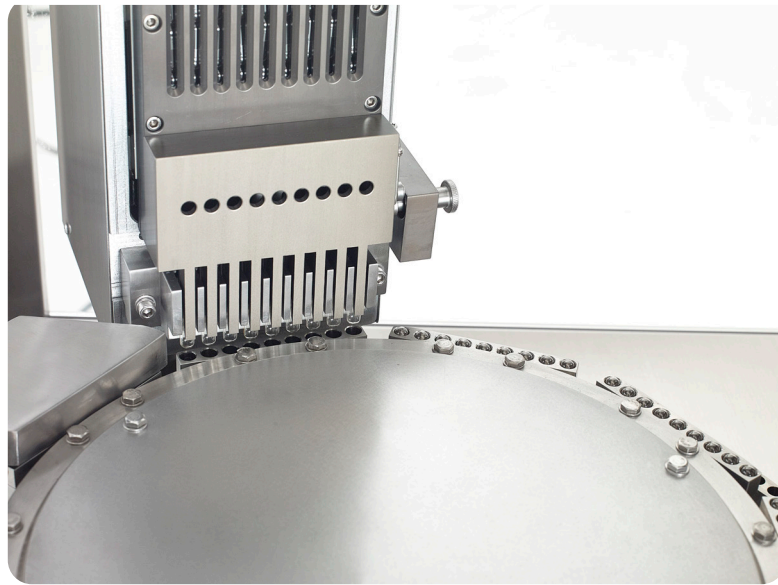

The FACH<sup>®</sup> range is a set of fully automatic capsule fillers that accurately and efficiently produce capsules of varying sizes per minute. By using intermittent motion and stations for dosing and tamping, the FACH<sup>®</sup> range provides precise capsule orientation and dosing with a high filling rate. The FACH<sup>®</sup> range has been designed for exceptional output and efficiency while keeping batch profitability as high as possible with minimal downtime. The table below shows the capabilities of each machine in the FACH<sup>®</sup> range:

Product	FACH <sup>®</sup> 400	FACH <sup>®</sup> 1200	FACH <sup>®</sup> 2000	FACH <sup>®</sup> 3800
Maximum Capsules per Minute	400	1,200	2,000	3,800
Capsule Size	00 / 0 / 1 / 2 / 3 / 4 / 5	00 / 0 / 1 / 2 / 3 / 4 / 5	00 / 0 / 1 / 2 / 3 / 4 / 5	00 / 0 / 1 / 2 / 3 / 4 / 5
Filling Precision	±3%	±3%	±3%	±3%
Filling Bores	3	9	18	27

The purpose of this document is to support your understanding of the FACH<sup>®</sup> range's components, features, functions, and design. With this manual, you will be able to successfully operate and maintain your FACH<sup>®</sup> range machine.

The user manual's content includes:

- Important safety information
- FACH<sup>®</sup> range installation instructions
- Description of the FACH<sup>®</sup> range's operation
- FACH<sup>®</sup> range maintenance information
- Appendix with supplemental information

# Training

FACF® range training is essential for the machine's successful operation and your personal safety. There are several methods to prepare you for working with the FACF® range.

## On-Site/Off-Site Training

LFA technicians can travel and train you at your own facility with your own machines. LFA also offers free training at our UK, USA, and Taiwan facilities for all our customers and their teams. For more information, go to <https://www.lfacapsulefillers.com/services>

## Training via Video Chat/Phone

Using an online video chat system, an LFA technician can interact face-to-face with you and assist with your understanding of the machine. Or, if you prefer, LFA can provide training via phone for all customers who call the office. To set up a training, call or email your local LFA office:

### UK

#### Phone

+44 (0) 0345 165 20 25

#### Email

[sales@lfamachines.com](mailto:sales@lfamachines.com)

### USA

#### Phone

(682) 312-0034

#### Email

[sales.usa@lfamachines.com](mailto:sales.usa@lfamachines.com)

### Taiwan

#### Phone

+886 2773 74704

#### Email

[sales.asia@lfamachines.com](mailto:sales.asia@lfamachines.com)

## LFA Articles

LFA writes informative articles about capsules and capsule fillers, which includes instructions, procedures, and guides. To access the articles, go to <https://www.lfacapsulefillers.com/articles>

## LFA Videos

LFA has created several videos involving the FACF® range and other capsule fillers. To access the videos, go to <https://www.lfacapsulefillers.com/videos> or <https://www.youtube.com/user/TabletPilPress>

# Installation

## Tools and Materials Needed

Before you install and operate the FACF® range, it is best to have the following tools and materials on hand for general operation and maintenance:

- Forklift
- Pallet jack
- Crowbar
- Hammer
- Socket wrench set
- Metric wrench set
- Crosshead screwdriver
- Flathead screwdriver
- Set of metric Allen keys with ball ends
- Feeler gauge
- Long wire pipe cleaner
- Toothbrush
- Cleaner (e.g. Member's Mark Commercial Lemon Disinfectant)
- Sanitizer (e.g. Member's Mark Commercial Sanitizer)
- Lubricant (NSF approved type for food grade products)
- Permanent marker
- Cleaning brush/paintbrush
- Plastic sheet or something similar to cover machine
- Safety goggles
- Hairnet and/or beard net (food grade products only)
- Sterile shoe covers (food grade products only)

## The Appropriate Workstation for the Machine

The floor on which the machine is to be placed must support the FACF® range's 812 kg-2400 kg (about 1,790 lbs-5,291 lbs) weight. The table below shows the static floor loading limit for each machine in the FACF® range:

Machine	Static Floor Loading Limit
FACF 400®	11.46 kN/m <sup>2</sup>
FACF 1200®	13.65 kN/m <sup>2</sup>
FACF 2000®	33.74 kN/m <sup>2</sup>
FACF 3800®	133.16 kN/m <sup>2</sup>

The machine's motor requires a three-phase power supply of 220 V/380 V. Ensure to position the machine near an appropriate electrical plug.

## Environmental Conditions

It is important that the environment in which you operate and store the FACF 1200® has the appropriate temperature and relative humidity levels. These two environmental factors can potentially cause the machine to rust and/or cause the capsules to have a lower quality. The table below shows the acceptable temperature and relative humidity levels:

Machine	Temperature		Humidity
FACF 1200®	°C	°F	20-80% RH
	0-40	32-104	

The shipping crate will contain the following:

1. The FACF®



2. The Tooling (already installed)



3. Anti-vibration feet



4. Toolkit including:

- Tooling Calibration Set (set of two long pins and two small pins)
- 4-soft bristle brush
- Paintbrush
- Crosshead screwdriver
- Flathead screwdriver
- Oil canister

5. Vacuum Pump and Filter

## Unpacking the FACF® Range

### Tools Needed

- Crowbar
- Hammer
- Socket wrench set
- Forklift (lift 2000 lbs minimum)
- Anti-vibration feet

### Instructions

1. Pry open each side of the shipping container with a crowbar and hammer and remove them.
2. Remove the Filter, Vacuum Pump, Toolkit, and Power Cable.
  - 2.1 Note: Be careful not to drop the heavy Vacuum Pump.
3. Remove the bolts on the shipping container's base with a socket wrench.
  - 3.1 Note: Keep the nuts, bolts, and the shipping container's base in case you need to move or relocate the machine.
4. Place the forklift underneath the machine and lift it.
  - 4.1 Note: Lift the machine high enough to insert the anti-vibration feet.
5. Attach the anti-vibration feet to each bottom corner of the machine.
6. Carefully lower the machine to the ground.

## Positioning the FACF<sup>®</sup> Range



**WARNING:** To prevent personal injury, wear steel toe boots and heavy duty grip gloves while transporting the FACF<sup>®</sup> range.

Because of its weight, LFA does NOT recommend carrying the machine manually but rather with a forklift. At least two people should be involved (one operating the forklift and one stabilizing the machine) in removing the machine from the shipping container and placing it in the workspace.

### Moving the FACF<sup>®</sup> with a Forklift

#### Tools Needed

- Pallet jack
- Heavy duty grip gloves
- Steel toe boots

#### Instructions

1. Raise the machine from the ground with a pallet jack.
2. Carefully guide the machine to the desired location.
  - 2.1 Note: The machine's motor requires a three-phase power supply of 220 V/380 V. Ensure to position the machine near an appropriate electrical plug.
3. Carefully lower the pallet jack until the anti-vibration feet make contact with the floor.
4. Place the Filter on top of the Vacuum Pump.
  - 4.1 Note: Use plumber's tape around the threaded part of the Vacuum Pump to ensure a good seal to reduce pressure loss.
5. Plug in the Vacuum Compressor and main power cable.
6. Plug in the Vacuum Pump's hose and tighten it with a flathead screwdriver.
7. Insert the 8 mm/12 mm push fit airline.

# Controls

## Basic Components



A description of the principal components follows:

- The **Capsule Hopper** holds the empty capsules.
- The **Capsule Sewing Station** aligns the capsules in the correct position with a magazine and inserts them into the capsule die segments.
- The **Vacuum System** separates the capsule caps and bodies.
- The **Powder Hopper** contains the mix that will be encapsulated.
- The **Auger** distributes the mix into the Tooling station and into the capsule bodies.
- The **Tamping Station** compresses the powder into a slug, which then gets pushed into the capsule body.

## Control Console



1. Run machine
2. Emergency Stop
3. Isolator Switch

## Main Digital Control Console

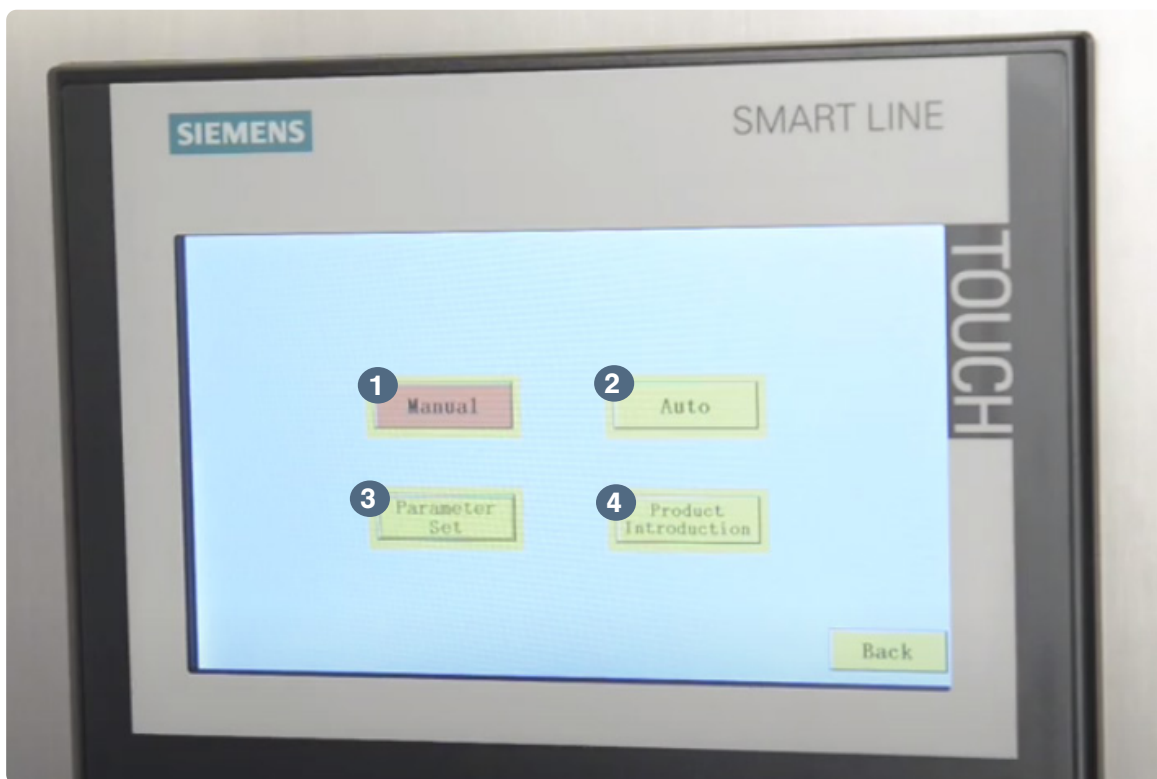

1. Manually run/jog different controls of the machine such as the main operation, vacuum, feeding powder, and vacuum cleaner.
2. Start/stop automatic operation for the

machine, adjust the main speed, and see the capsule count.

3. Set machine parameters .
4. See machine information (e.g. serial number).



## **FACF® Range Process**

The basic mechanism of the FACF® range involves orienting, separating, filling, closing, and ejecting capsules.

### **Orienting and Inserting Capsules into the Capsule Die Segments**

When the machine begins operation, the capsules in the Hopper are fed into the magazine vertically. With each movement of the machine, the gate of the Capsule Magazine releases one capsule, and the horizontal forks orientate it. Then, the vertical forks push the capsules into the Capsule Die Segments with all caps in the upward position.

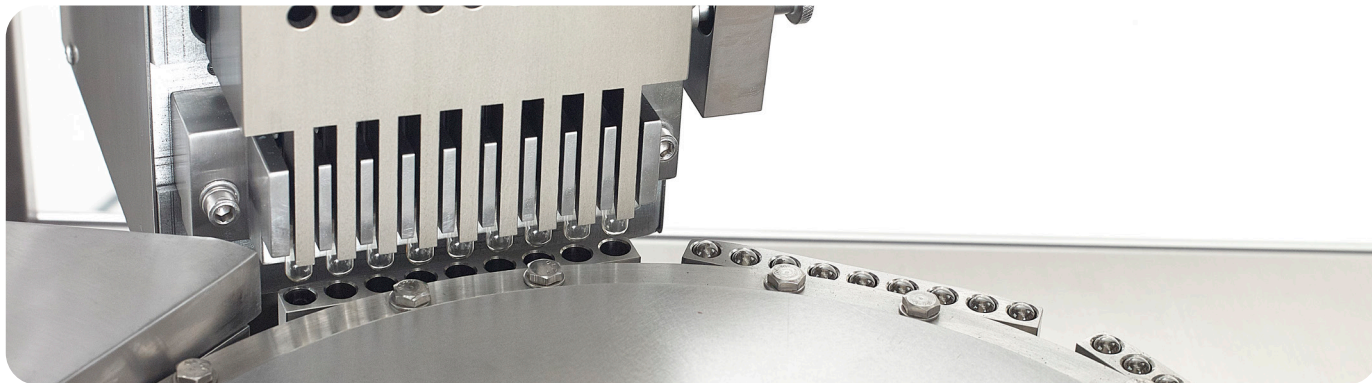

### **Filling the Capsule Bodies with Powder**

After the vacuum system separates the capsule bodies and capsule caps, the lower Capsule Die Segment with the capsule bodies is extended. The filling rod then pushes the pressed powder slug in the capsule bodies.



### **Capsule Sealing and Ejection**

Once defective capsules have been rejected, the capsules are snapped shut. After that, the finished capsules are ejected and then cleaned by the vacuum cleaner and compressed air.



## How to Fill Capsules with the FACF® Range

### Tools and Materials Needed

- Empty capsules
- Raw material formulation
- Fully assembled FACF®
- Receptacle for filled capsules
- Safety goggles
- Disposable latex/rubber gloves (for food grade products and to protect hands from grease)
- Hairnet and/or beard net (food grade products only)
- Sterile shoe covers (food grade products only)

**CAUTION – PRIOR TO OPERATING MACHINE:** Check to see that all four panel doors of the machine are completely shut (there are sensors on them that prevent the machine from running if any panel door is open).



Manually rotate for 1-3 cycles. Then, press the green button, push the vacuum pump button on the touch screen and check the direction of the rotation.

Ensure that there is a sufficient amount of powder in the Powder Hopper.

Ensure to start the vacuum pump first before starting the main motor.

### Instructions

Note: Wear latex/rubber gloves (and appropriate food grade attire if applicable) during this process.

1. Place the receptacle for filled capsules near the ejection chute.
2. Pour the empty capsules into the Capsule Hopper.
3. Turn the Isolator Switch to power on the machine.



4. Press the language button to enter the main screen.

4.1 Note: There are two logins for operators of this machine. The login information is:

Username: 1

Password: 111

Username: 2

Password: 222

5. Press the Manual button.

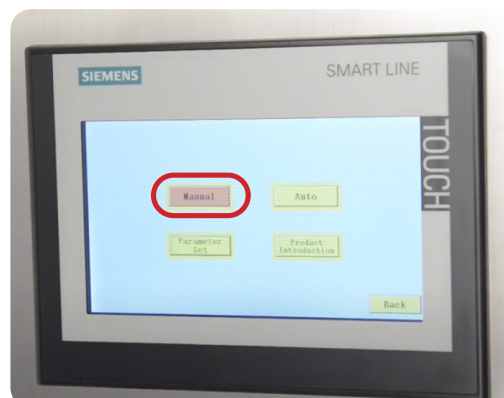



6. Press the buttons in the following order to manually run the machine and prime the Powder Hopper.



7. Press the buttons in reverse order to turn off manual mode.



8. Press the Back button to return to the main screen.

9. Press the Auto button.

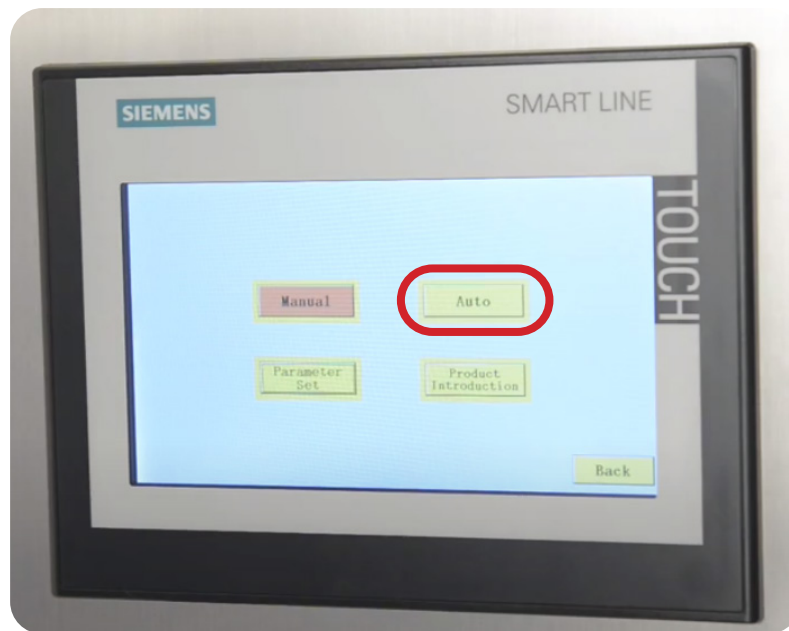

10. Press the Feeding Powder Jog button to prime the Hopper.

11. Press the Auto Start button to run the machine.

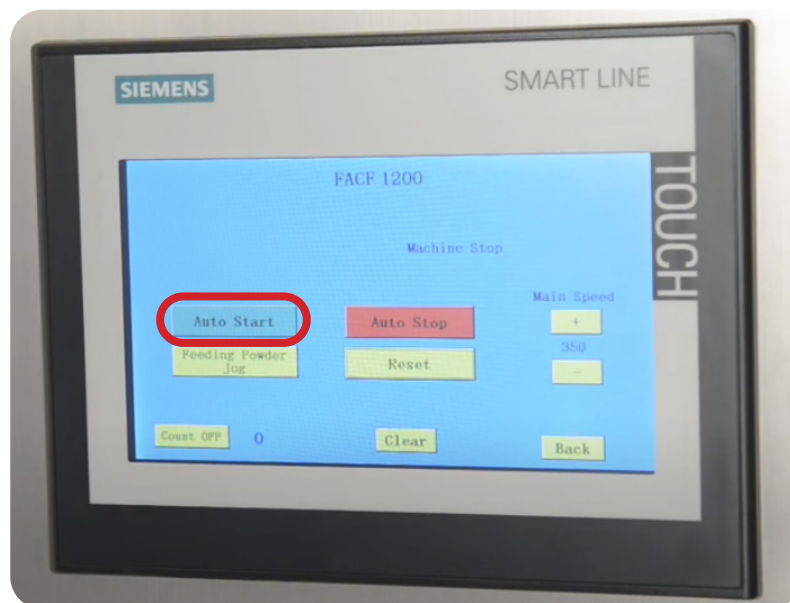

# Settings and Adjustment

The FACF® range's settings can be adjusted. Tuning the machine can help with changing the capsule dose and machine operation.

## Main Speed

The FACF® range's main speed for capsule output can be adjusted in both automatic and manual modes.

### Tools and Materials Needed

- Disposable latex/rubber gloves (for food grade products and to protect hands from grease)
- Hairnet and/or beard net (food grade products only)
- Sterile shoe covers (food grade products only)

### Instructions

Note: Wear latex/rubber gloves (and appropriate food grade attire if applicable) during this process.

1. Run the machine.
2. Press the Manual or Auto buttons from the main screen.
  - 2.1 Note: The main speed can be adjusted from either operation mode.

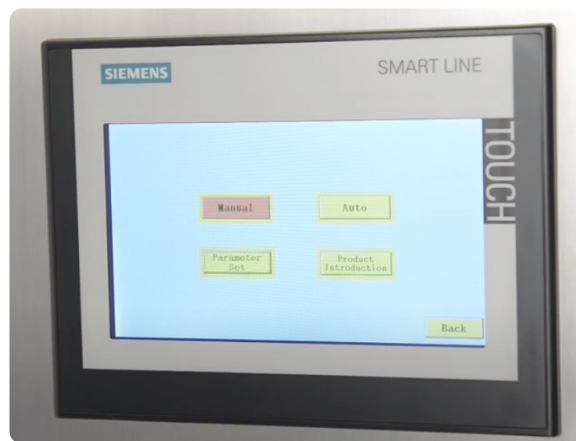

3. Press the + and - buttons to increase or decrease the main speed.

3.1 Note: The main speed can also be manually entered by pressing the current speed and inputting the main speed numerically.

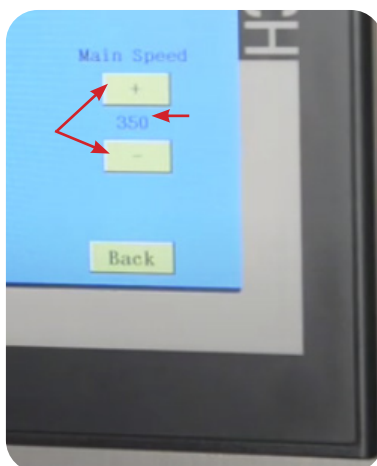

4. Ensure that the ejected capsules have a consistent weight after the adjustment.

4.1 Note: Powders with poor flow will have issues with increased speed.

## Main Start Delay, Automatic Filling Time, and No Filler Delay Stop

These adjustments are explained below:

- **Main Start Delay** - This is the amount of time that the machine will wait before starting the main rotation of the Tamping Station and the Capsule Die Segments (the vacuums, auger, and compressor will run first). It should be normally set at 0.5 seconds; however, if the first capsules in rotation are not separating correctly, increase the delay.
- **Automatic Feeding Time** - This is the number of seconds that the auger will rotate before pausing. This will need to be reduced if the auger is overfilling the Tamping Station. If the capsule weights are inconsistent, the sensor's height needs to be raised and the auger's running time needs to be increased in the range of 3-20 seconds.
- **No Filler Delay Stop** - This is the when the machine will automatically shut off if powder is not registered by the sensor in the Tamping Station. If the machine is shutting off with the alarm that states the machine has run out of powder, then the No Filler Delay Stop needs to be increased. Always ensure that the Powder Hopper is full and that the alarm is not being set off because it is actually out of powder before increasing this adjustment.

### Tools and Materials Needed

- Disposable latex/rubber gloves (for food grade products and to protect hands from grease)
- Hairnet and/or beard net (food grade products only)
- Sterile shoe covers (food grade products only)

### Instructions

Note: Wear latex/rubber gloves (and appropriate food grade attire if applicable) during this process.

1. Run the machine to determine the adjustment.
2. Press the Parameter Set button from the main screen.

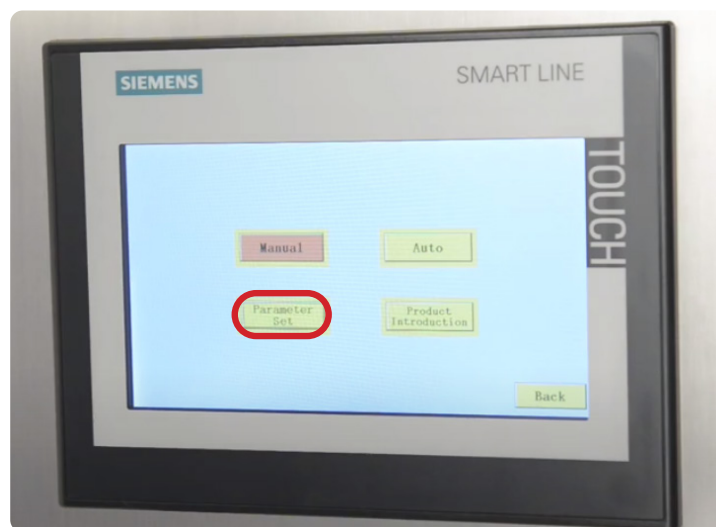

3. Input the seconds for each of the parameters.

3.1 Note: If the powder is fluffy and flour-like, it might need a few extra seconds to make its way down into the Hopper. To make this happen, increase the parameter delays.



## Capsule Weight Adjustment

Tuning the FACF® range involves adjusting the five tamping stations located below the Powder Hopper. The weight of the capsule can be increased or decreased by making these adjustments. To watch a video of tuning the FACF®, go to <https://www.lfacapsulefillers.com/videos/tuning-your-facf-capsule-filler>

### Tools and Materials Needed

- Metric wrench set
- Permanent marker
- Disposable latex/rubber gloves (for food grade products and to protect hands from grease)
- Hairnet and/or beard net (food grade products only)
- Sterile shoe covers (food grade products only)



**WARNING:** To prevent any potential personal injury, ALWAYS unplug the FACF® from the electrical outlet when making adjustments.

### Instructions

Note: Wear latex/rubber gloves (and appropriate food grade attire if applicable) during this process.

1. Open the machine's panel doors and insert the Handle onto the Motor.
2. Operate the machine manually to determine the capsule weight adjustment.





3. Loosen each station's adjustment bolt with a wrench.



**NOTE:** Read this before making adjustments. The capsule weight adjustment knobs **MUST** be turned sequentially with #5 being the highest and #1 being the lowest. To help with remembering the correct order, mark each knob as follows and adjust each in that order:



4. Turn each adjustment knob sequentially an equal amount of times.
  - 4.1 Note: Raise the knobs to decrease the weight and lower them to increase the weight.
5. Tighten each station's adjustment bolt with a wrench.
6. Manually operate the machine to determine if weight adjustment is correct.



**WARNING:** To prevent any potential personal injury, remove the Handle from the Motor before plugging in machine and automatic operation.



## Capsule Hopper Adjustment

This adjustment affects the flow of the capsules from the Capsule Hopper to the Capsule Magazine. If the flow rate is too high, capsules can spill over. If it is too low, capsules will not enter the Capsule Die Segments.

### Tools and Materials Needed

- Disposable latex/rubber gloves (for food grade products and to protect hands from grease)
- Hairnet and/or beard net (food grade products only)
- Sterile shoe covers (food grade products only)



**WARNING:** To prevent any potential personal injury, ALWAYS unplug the FACF® from the electrical outlet when making adjustments.

### Instructions

Note: Wear latex/rubber gloves (and appropriate food grade attire if applicable) during this process.

1. Rotate the lock to loosen the Capsule Hopper's gate.



2. Slide the gate up and/or down to adjust the capsule flow.

2.1 Note: Sliding the gate up increases the flow of the capsules. Sliding the gate down decreases the flow of the capsules.

## Capsule Feeding Gate Adjustment

The correct timing of the retaining gate ensures that one capsule comes out of the magazine fork at a time.

### Tools and Materials Needed

- Set of Allen keys with ball ends
- Disposable latex/rubber gloves (for food grade products and to protect hands from grease)
- Hairnet and/or beard net (food grade products only)
- Sterile shoe covers (food grade products only)



**WARNING:** To prevent any potential personal injury, ALWAYS unplug the FACF® from the electrical outlet when making adjustments.

### Instructions

Note: Wear latex/rubber gloves (and appropriate food grade attire if applicable) during this process.

1. Remove the fastening screws with an Allen key.
2. Adjust the limit block until one capsule is correctly discharged from the magazine at a time.
  - 2.1 Note: Raise the limit block up and away from the Capsule Magazine if not enough capsules are coming out. Adjust it down and towards the Capsule Magazine if too many capsules are coming out. If only one track of the Capsule Magazine is not putting out capsules, one of the springs may be bent.

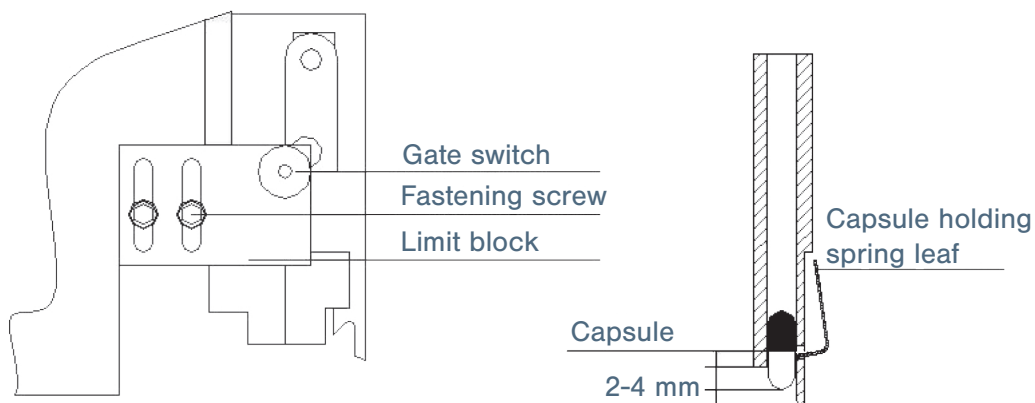

## Dosing Disc and Seal Ring Gap Adjustment

The gap between the dosing disc and the seal ring should be between 0.05 mm to 0.1 mm. If the powder's granules are large, the gap should be increased as a smaller gap could cause resistance between the dosing disc and seal ring. Powder leakage can also indicate if the gap is too large.

### Tools and Materials Needed

- Set of Allen keys with ball ends
- Set of metric wrenches
- Feeler gauge
- Disposable latex/rubber gloves (for food grade products and to protect hands from grease)
- Hairnet and/or beard net (food grade products only)
- Sterile shoe covers (food grade products only)



**WARNING:** To prevent any potential personal injury, ALWAYS unplug the FACF® from the electrical outlet when making adjustments.

### Instructions

Note: Wear latex/rubber gloves (and appropriate food grade attire if applicable) during this process.

1. Remove the Powder Hopper from the machine and remove the excess powder.
2. Manually rotate the machine by hand to move the tamping pin holder to the highest position.

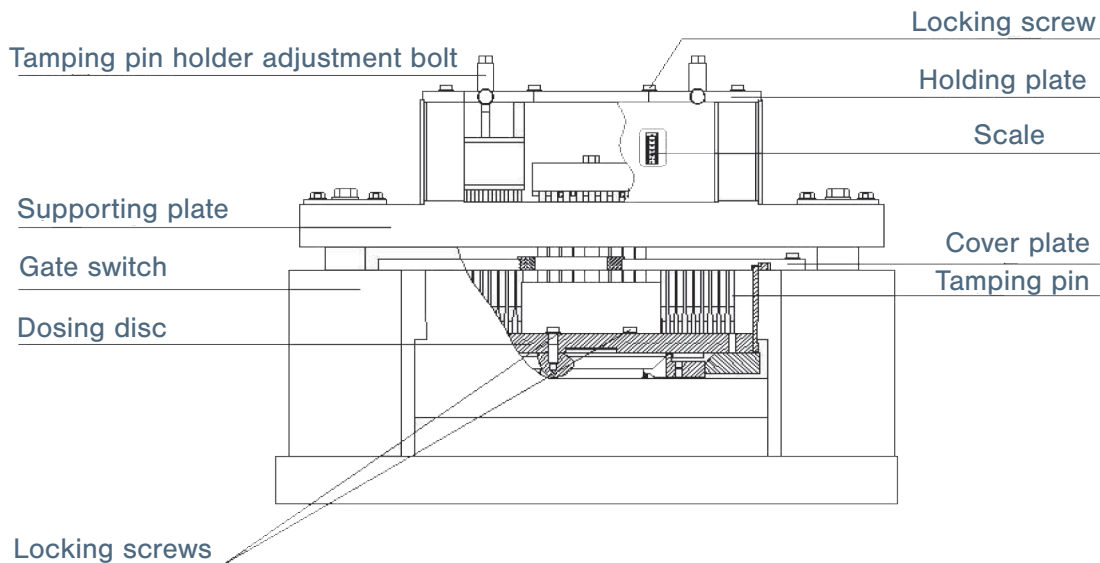

3. Loosen the locking screw on the tamping pin holder and unscrew the adjusting bolt to remove the holder.
4. Loosen the two big screws on both sides of the supporting plate to take it off.
5. Remove the four screws of the powder trough cover and take it off.
6. Loosen the six screws that secure the dosing disc and clean any excess powder between the dosing disc and seal ring.

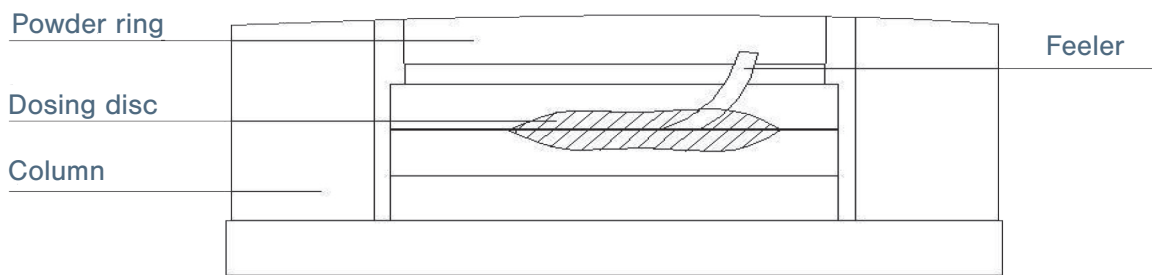

7. Rotate the bolt to adjust the gap between the dosing disc and sealing ring.
  - 7.1 Note: Rotate the bolt counterclockwise to lower the seal ring. Rotate the bolt clockwise to raise the seal ring.
8. Measure the gap with a feeler gauge to ensure that it is between 0.05 mm and 0.1 mm.
9. Tighten the screws and reassemble the dosing device.

## Powder Scraper Adjustment

Anytime the dosing disc is replaced, the gap between the powder scraper and the dosing disc must be adjusted. The optimal measurement of the gap is 0.05 mm to 0.1 mm.

### Tools and Materials Needed

- Set of Allen keys with ball ends
- Set of metric wrenches
- Feeler gauge
- Disposable latex/rubber gloves (for food grade products and to protect hands from grease)
- Hairnet and/or beard net (food grade products only)
- Sterile shoe covers (food grade products only)



**WARNING:** To prevent any potential personal injury, ALWAYS unplug the FACF® from the electrical outlet when making adjustments.

### Instructions

Note: Wear latex/rubber gloves (and appropriate food grade attire if applicable) during this process.

1. Remove the Powder Hopper from the machine and remove the excess powder.
2. Loosen the fixed screws that are above and under the cover plate.

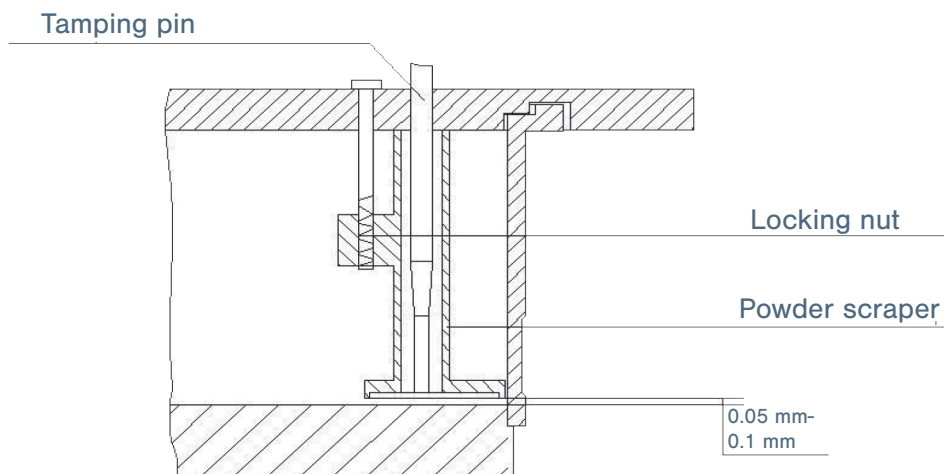

3. Rotate the adjusting screw to raise or lower the powder scraper.
4. Measure the gap with a feeler gauge to ensure that it is between 0.05 mm and 0.1 mm.
5. Tighten the fixed screws after determining the correct adjustment.

## Powder Sensor Adjustment

If the machine's sensor is unable to detect powder, its sensitivity must be adjusted.

### Tools and Materials Needed

- Set of Allen keys with ball ends
- Set of metric wrenches
- Metric ruler
- Disposable latex/rubber gloves (for food grade products and to protect hands from grease)
- Hairnet and/or beard net (food grade products only)
- Sterile shoe covers (food grade products only)



**WARNING:** To prevent any potential personal injury, ALWAYS unplug the FACF® from the electrical outlet when making adjustments.

### Instructions

Note: Wear latex/rubber gloves (and appropriate food grade attire if applicable) during this process.

1. Loosen the powder lever sensor's clamping screw.

1.1 Note: Please refer to the remove and replace Tooling instructions on page 39 for further information regarding the sensor.

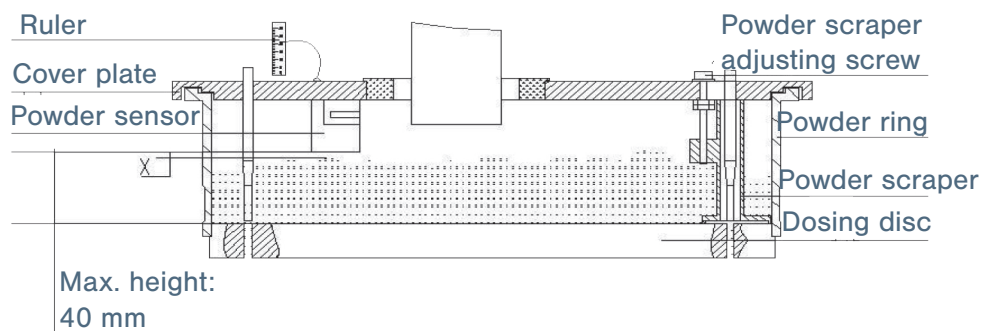

2. Raise or lower the sensor's height.

2.1 Note: Rotate the screw on top of the sensor to adjust the sensitivity. Increase the sensitivity if the sensor is unable to detect powder. However, if the Tamping Bowl is not filling with powder and the capsule weight is inconsistent, decrease the sensitivity. The distance between the sensor's terminal surface and the powder should be about 2 mm-8 mm.



## Capsule Closing Adjustment

If capsules are not sealing, adjust the upper closing plate and the lower pushing rod in the 10th station.

### Tools and Materials Needed

- Set of Allen keys with ball ends
- Set of metric wrenches
- Metric ruler
- Disposable latex/rubber gloves (for food grade products and to protect hands from grease)
- Hairnet and/or beard net (food grade products only)
- Sterile shoe covers (food grade products only)



**WARNING:** To prevent any potential personal injury, ALWAYS unplug the FACF® from the electrical outlet when making adjustments.

### Instructions

Note: Wear latex/rubber gloves (and appropriate food grade attire if applicable) during this process.

1. Loosen the upper plate's screws to adjust the height.
  - 1.1 Note: Ensure that the distance between the plate and the top of the capsule is 0.2 mm-0.3 mm.

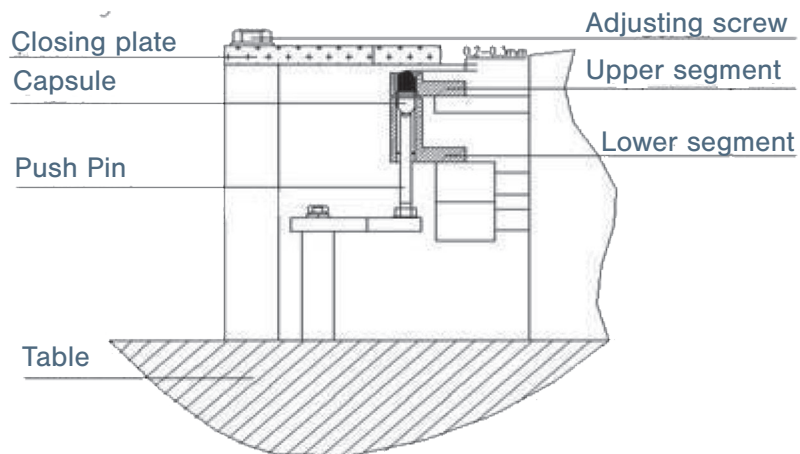

2. Insert an empty capsule into the Capsule Die Segment and manually rotate the machine by hand to move the pushing rod to the highest position.
3. Loosen the screws at both ends of the pushing rod and turn it to push up the capsule.
4. Tighten the screws whenever the capsule touches the closing plate and the pushing rod is at its highest point.

## Filled Capsule Ejection Adjustment

The adjustment of the ejection mechanism in the machine includes the guide plate and the pushing rod.

### Tools and Materials Needed

- Set of Allen keys with ball ends
- Set of metric wrenches
- Disposable latex/rubber gloves (for food grade products and to protect hands from grease)
- Hairnet and/or beard net (food grade products only)
- Sterile shoe covers (food grade products only)



**WARNING:** To prevent any potential personal injury, ALWAYS unplug the FACF® from the electrical outlet when making adjustments.

### Instructions

Note: Wear latex/rubber gloves (and appropriate food grade attire if applicable) during this process.

1. Loosen the guide plate's screws and move them to adjust the angle and position of capsule ejection.

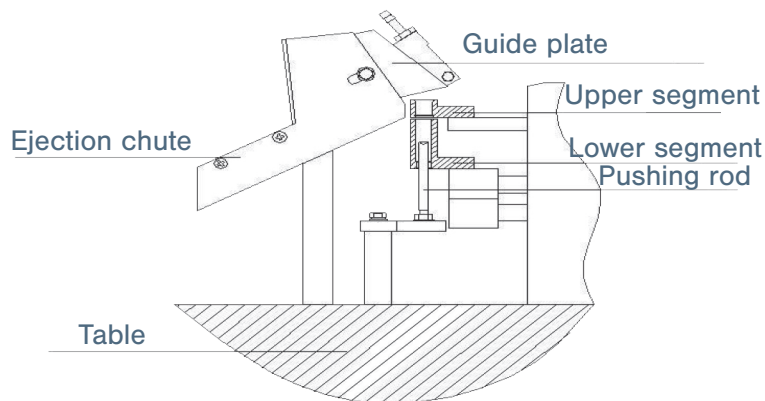

2. Loosen the screws at both ends of the pushing rod and turn it to adjust the ejection.
  - 2.1 Note: Please refer to the remove and replace Tooling instructions on page 39 for further information regarding the sensor.

## Timing Calibration

Calibrating the machine means checking the positions of the Die Segment Turret, Dosing Disc, Tamping Pins, and Sealing Pins, Ejection Pins, and Rejection Pins, which may require an adjustment of the position indicator.

### Tools and Materials Needed

- Set of Allen keys with ball ends
- Set of metric wrenches
- Disposable latex/rubber gloves (for food grade products and to protect hands from grease)
- Hairnet and/or beard net (food grade products only)
- Sterile shoe covers (food grade products only)



**IMPORTANT:** The timing calibration **MUST** be adjusted in the following order:

1. Die Segment Turret
2. Dosing Disc
3. Tamping Pins
4. Sealing Pins, Ejection Pins, and Rejection Pins

### Instructions

Note: Wear latex/rubber gloves (and appropriate food grade attire if applicable) during this process.

#### Part One: Die Segment Turret Timing and Set Up for Other Calibrations

1. Press the green button to turn on the HMI.



2. Press the Brake button on the HMI.
3. Rotate the machine by hand until the Die Segment Turret just begins to move.



4. Check the position indicator to ensure that the Die Segment Turret is at 360/360 degrees.  
4.1 Note: If it is not at this position, remove the bolt in the middle of the position indicator with an Allen key. Adjust the position indicator until it is at the correct degree and tighten its screw with an Allen key.



**Part Two: Dosing Disc Timing**

5. Manually rotate the machine until the position indicator is at 300 degrees.  
6. Check to see that the Dosing Disc begins to move.



- If the Dosing Disc moves, skip to step #10. If it does not move, proceed to step #7.  
7. Loosen the lock screw and disconnect the chain from the chain joint.

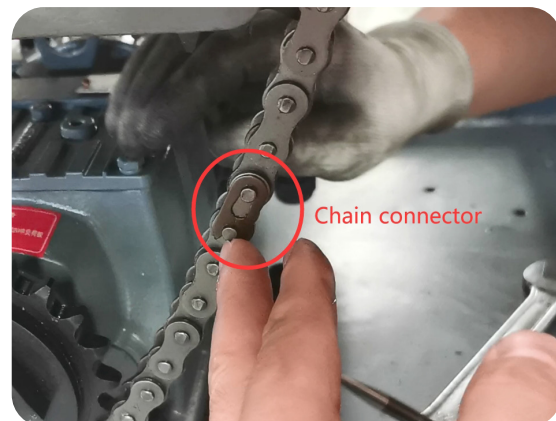
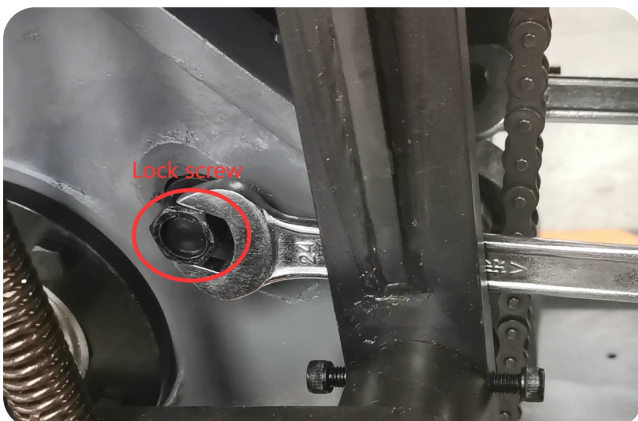

8. Rotate the Tamping Section gearbox until it begins to move.
  - 8.1 Note: Do NOT turn the gearbox that is connected to the Die Segment Turret.
9. Reconnect the chain to the main drive motor.
  - 9.1 Note: Ensure NOT to move either gearbox. Causing any more movement during this step can disrupt the calibration, which would require the entire process to start over from the beginning.

**Part Three: Adjust Tamping Pins Timing**

10. Manually rotate the machine until the position indicator is at 20 degrees.
11. Check to see that the Tamping Pins begin to move upwards. If it does not, move the Tamping Pin Cam until it is in the correct position.

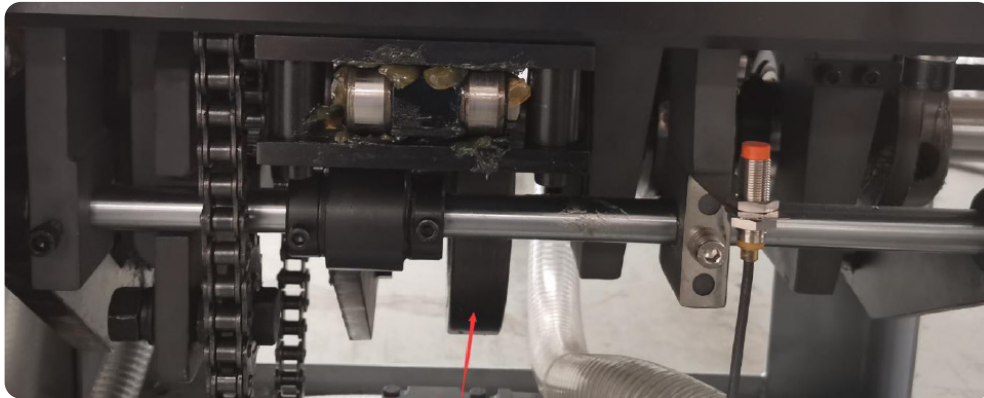

**Part Four: Adjust the Cams**

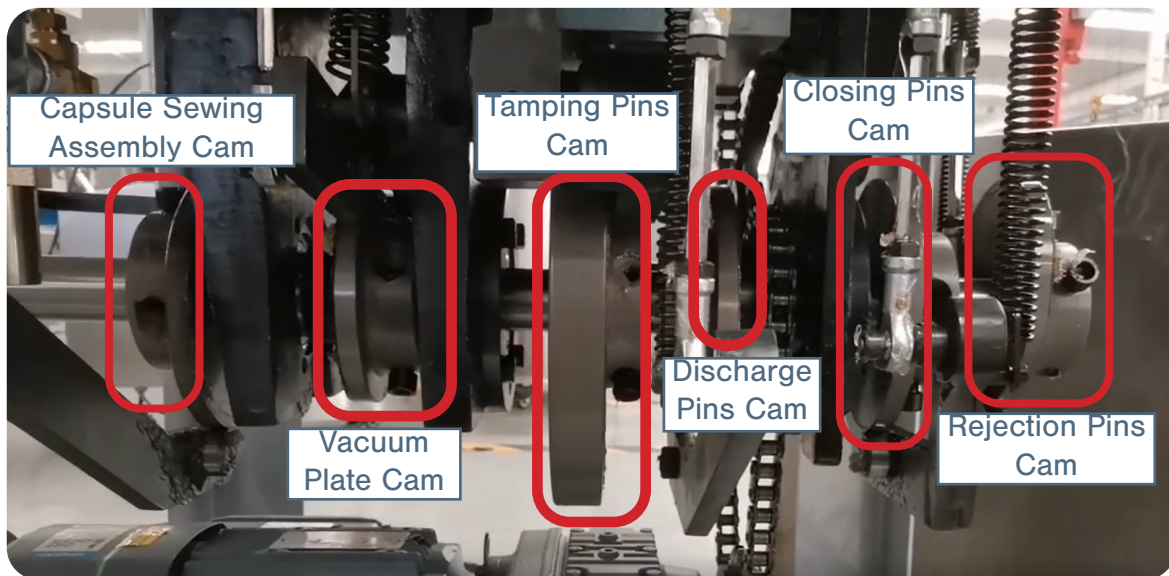



### Part Five: Adjust Capsule Sewing Assembly Cam Timing

12. Inch the machine to find the 2 convex lock screws on the cam and loosen them with an Allen key.

12.1 Note: This process is the same for all of the cams' timing calibration.



13. Continue to inch the machine to find the 2 concave screws and loosen them with an Allen key.

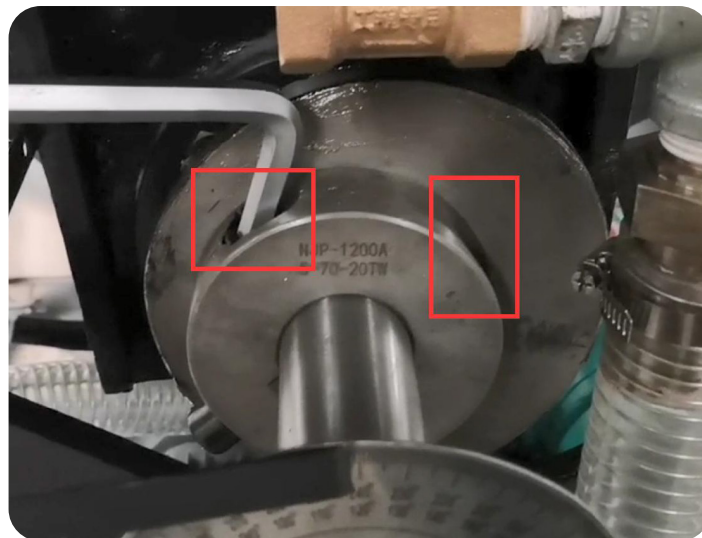

14. Rotate the cam to adjust the position of the capsule fork.

14.1 Note: Ensure that the capsule fork is at its highest point.

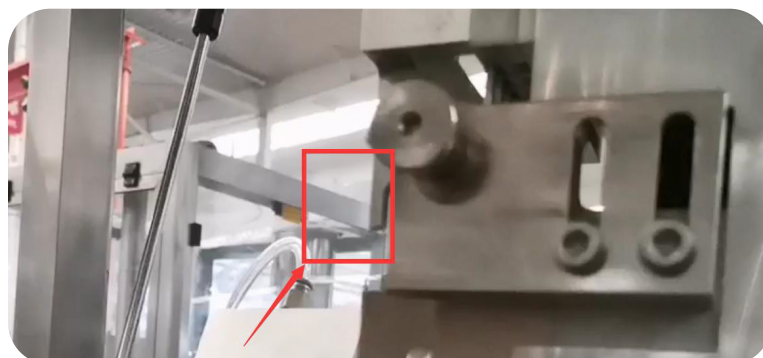

15. Once adjusted, hold the cam and secure the convex and concave screws back into the cam with an Allen key.



## Part Six: Adjust Vacuum Plate Timing Cam

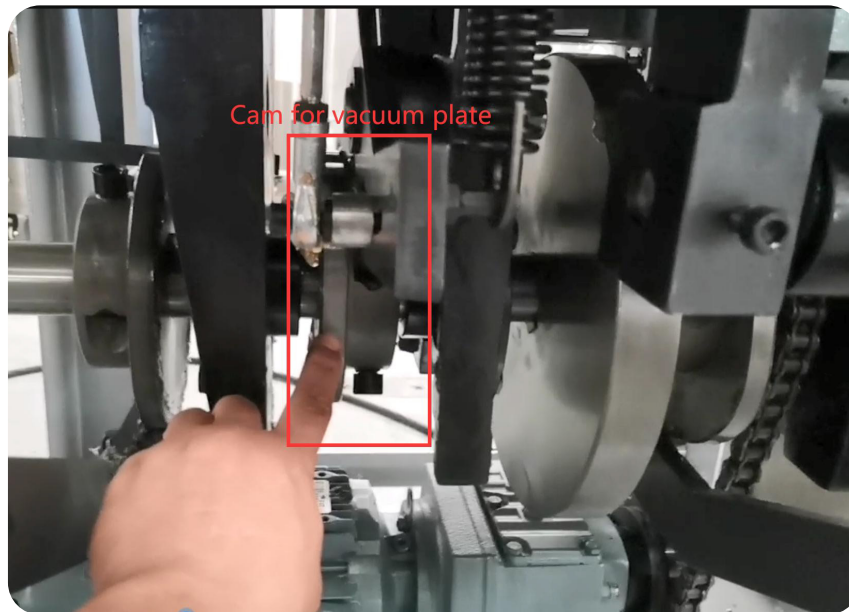

16. Inch the machine to find the 2 convex lock screws on the cam and loosen them with an Allen key.

16.1 Note: This process is the same for all of the cams' timing calibration.

17. Inch the machine to find the 2 concave lock screws on the cam and loosen them with an Allen key.

18. Inch the machine until the segment is right above the vacuum plate.



19. Rotate the cam so that the vacuum plate begins to raise from the lowest point into the die segment.



20. Once the vacuum plate begins to raise, hold the cam and secure the convex and concave screws back into the cam with an Allen key.

### Part Six: Adjust Discharge Pins, Closing Pins, and/or Rejection Pins Cam Timing

Note: This process works for each cam.

21. Inch the machine so that the segments begin to move.

The Discharge Pins should be closing and the Closing Pins and Rejection Pins should be at their lowest points.

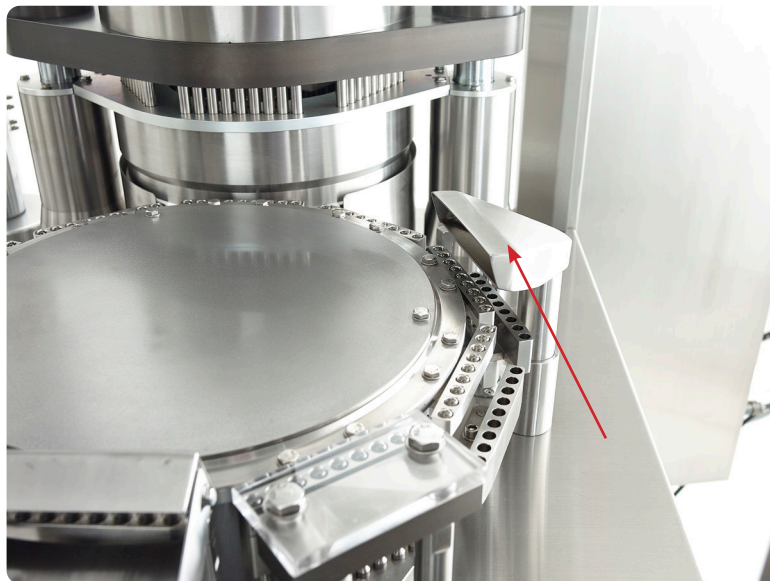
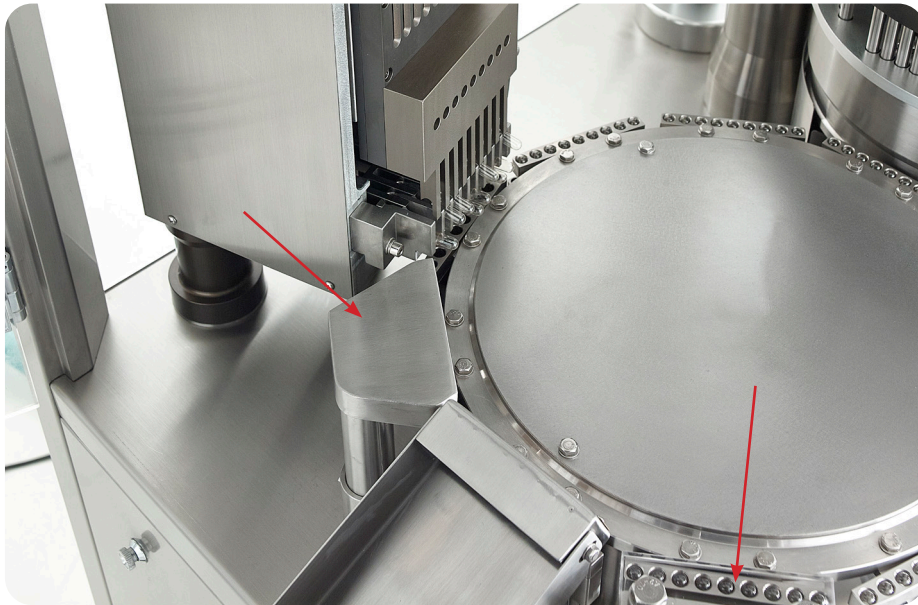

22. Find the cam that is out of calibration.

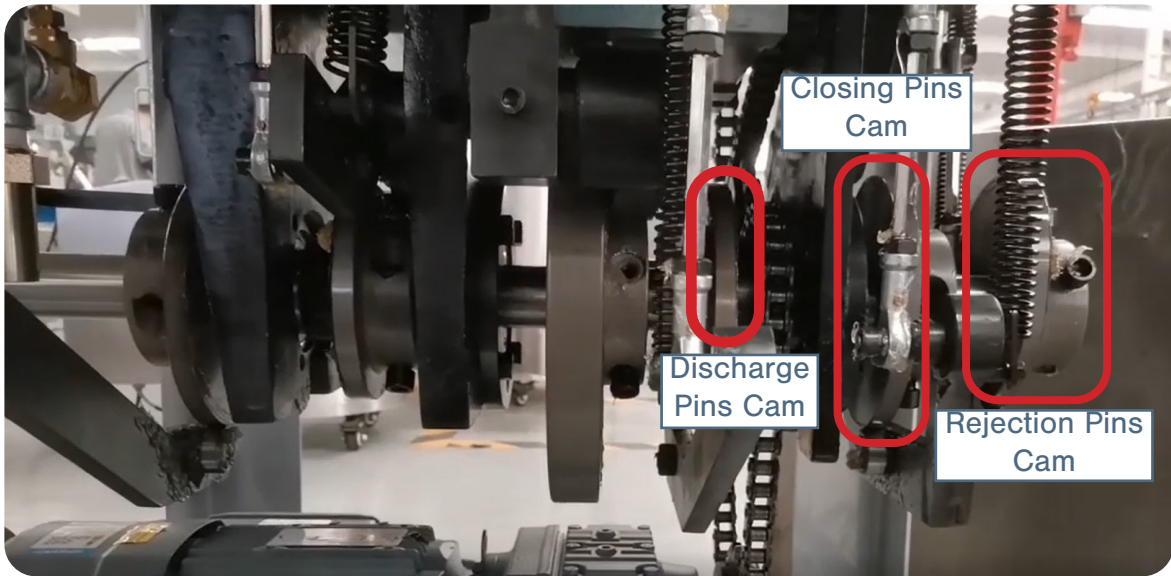

23. Inch the machine to find the 2 convex lock screws on the cam and loosen them with an Allen key.

24. Inch the machine to find the 2 concave lock screws on the cam and loosen them with an Allen key.

25. Inch the machine to move the segments.

26. Rotate the cam until the Discharge Pins/Closing Pins/Rejection Pins reach the lowest point.

26.1 Note: Photo below is of the Discharge Pins.



27. Once the Discharge Pins/Closing Pins/Rejection Pins are at their lowest point, hold the cam and secure the convex and concave screws back into the cam with an Allen key.

# Maintenance

To ensure that the FACF® will have a long operational life, maintenance is essential. This section includes methods for replacing parts, troubleshooting solutions, and how often to grease and clean your machines to keep its performance optimal.

## General Maintenance Prescriptions

- Use the maintenance checklist (found in the Appendix) before, during, and after machine operation.
- Make sure all grease points are maintained and regularly lubricated.
- Use an appropriate amount of lubricant. Excess grease can drip into the capsules.
- Before reassembling the machine after cleaning, make sure that the parts are dried and oiled.
- Constantly check for any loose nuts and/or screws before, during, and after machine operation.
- If the machine is not used for more than a week, place the Tooling in a container and cover in lubricant.

## Lubrication

Regularly greasing your machine is vital to prolonging its operational life. Parts that are not greased properly can make the machine seize up and cause major problems later. LFA recommends maintaining a lubrication schedule for your FACF®, which can be found in this section.

### Tools and Materials Needed

- Hydraulic oil ISO VG 46 (use H1 NSF for food grade products)
- NLGI grade 1 grease (use H1 NSF for food grade products)
- Set of metric Allen keys with ball ends
- Disposable latex/rubber gloves (for food grade products and to protect hands from grease)
- Hairnet and/or beard net (food grade products only)
- Sterile shoe covers (food grade products only)



**WARNING:** To prevent any potential personal injury, unplug the FACF 1200® from the electrical outlet.

### Instructions



Note: Wear latex/rubber gloves (and appropriate food grade attire if applicable) during this process.



1. Apply one layer of grease onto the work surface of the cams and rollers.
  - 1.1 Note: To see drawings of lubrication point locations, please refer to the Lubrication Schedule on page 35.
2. Apply lubrication oil to joint bearings, sealing bearings, and sliding guides.
3. Grease the ball bearings, needle bearing, and linear bearings.
4. Check the driving chains' tightness and apply lubricant.
5. Replenish the oil of the main driving and feeder decelerators.

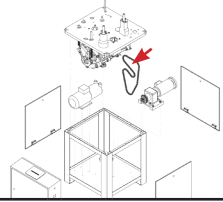
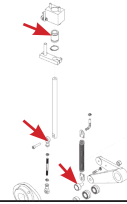

## Lubrication Schedule

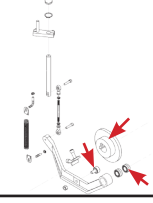
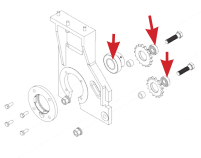
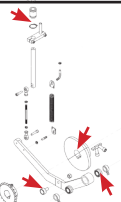
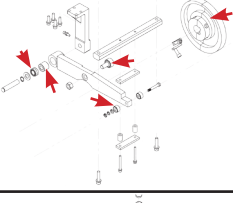
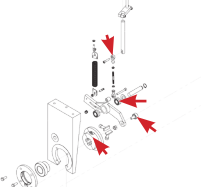
LFA recommends the following FACP® range parts to be lubricated according to the following frequency:

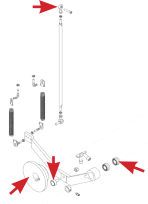
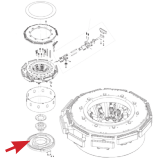
Location	Parts	Image	Frequency	Type of Lubricant
Driving Part Assembly	<ul style="list-style-type: none"> <li>Chain</li> </ul>		Visually inspect chain and apply when dry (approximately weekly).	Oil or grease
Rejection Driving Assembly	<ul style="list-style-type: none"> <li>Cam bearing</li> <li>Needle bearing</li> <li>Cam</li> </ul>		<p>Visually inspect bearings and apply when dry (regularly).</p> <p>Visually inspect cam and apply when dry (weekly).</p>	NLGI Grade 1
FACP®	<ul style="list-style-type: none"> <li>Tooling</li> </ul>		Cover with oil and store in container after cleaning.	Mineral Oil
Press Driving Assembly	<ul style="list-style-type: none"> <li>Cam bearing</li> <li>Needle bearing</li> <li>Cam</li> </ul>		<p>Visually inspect bearings and apply when dry (regularly).</p> <p>Visually inspect cam and apply when dry (weekly).</p>	NLGI Grade 1
Main Shaft Support Assembly	<ul style="list-style-type: none"> <li>Deep groove ball bearing</li> <li>Spherical surface ball bearing</li> </ul>		Visually inspect bearings and apply when dry (regularly).	NLGI Grade 1
End Production Press Driving Assembly	<ul style="list-style-type: none"> <li>Needle bearing</li> <li>Cam</li> <li>Linear bearing</li> <li>Cam bearing</li> </ul>		<p>Visually inspect bearings and apply when dry (regularly).</p> <p>Visually inspect cam and apply when dry (weekly).</p>	NLGI Grade 1
Dosing Driving Assembly	<ul style="list-style-type: none"> <li>Cam bearings</li> <li>Needle bearings</li> <li>Cam</li> </ul>		<p>Visually inspect bearings and apply when dry (regularly).</p> <p>Visually inspect cam and apply when dry (weekly).</p>	NLGI Grade 1
Vacuum Driving Assembly	<ul style="list-style-type: none"> <li>Cam bearing</li> <li>Needle bearing</li> <li>Cam</li> <li>Linear bearing</li> <li>Pin end bearing</li> </ul>		<p>Visually inspect bearings and apply when dry (regularly).</p> <p>Visually inspect cam and apply when dry (weekly).</p>	NLGI Grade 1

Location	Parts	Image	Frequency	Type of Lubricant
Sequence Driving Assembly	<ul style="list-style-type: none"> <li>• Cam bearing</li> <li>• Needle bearing</li> <li>• Cam</li> <li>• Pin end bearing</li> </ul>		<p>Visually inspect bearings and apply when dry (regularly).</p> <p>Visually inspect cam and apply when dry (weekly).</p>	NLGI Grade 1
Round Table Seat Assembly	<ul style="list-style-type: none"> <li>• Disc cam</li> </ul>		<p>Visually inspect cam and apply when dry (weekly).</p>	NLGI Grade 1
Top of Powder Hopper	<ul style="list-style-type: none"> <li>• Feeding decelerator</li> </ul>		<p>Visually inspect and replenish when necessary. Replace entirely once every 6 months.</p>	Hydraulic oil ISO VG 46 (H1 NSF for food grade products)
Inside Machine Body near Motor	<ul style="list-style-type: none"> <li>• Main drive decelerator</li> </ul>		<p>Visually inspect and replenish when necessary. Replace entirely once every 6 months.</p>	Hydraulic oil ISO VG 46 (H1 NSF for food grade products)



## Dismantling for Repair and Replacement

Eventually due to wear and tear, some parts of the FACF® range will need to be removed for repair and replacement. To prevent any delays in your capsule production, it is best practice to keep extra parts just in case.

To buy a FACF® range part replacement, simply go to

<https://www.lfacapsulefillers.com/products/machine-spare-parts/facf-range-spare-parts>

### Warranty

To access LFA's warranty policy, go to <https://www.lfacapsulefillers.com/warranty>

If your part is eligible for warranty, have your part's serial number on hand and please contact LFA:

#### UK

##### Phone

+44 (0) 0345 165 20 25

##### Email

[sales@lfamachines.com](mailto:sales@lfamachines.com)

#### USA

##### Phone

(682) 312-0309

##### Email

[sales.usa@lfamachines.com](mailto:sales.usa@lfamachines.com)



**WARNING:** To prevent any potential personal injury, ALWAYS unplug the FACF® from the electrical outlet when replacing parts.

## Wear Parts and Causes of Damage

Wear Part	Cause of Damage
Capsule Holding Pins	The Capsule Holding Pins are an integral part of the capsule sowing section. They hold the capsules in the cartridge and time their release. They can become damaged in the event of a jam, during cleaning, or if mishandled.
Bearings for Capsule Segment	Behind the casing to the capsule sewing section, there are 8 bearings that are used to maintain a smooth back/forward and up/down motion to orient and sew the capsules.
Plastic Inserts for Capsule Segment	The capsule segments rotate the Turret and are facilitated by plastic inserts. These segments can become worn, which can cause fine powder to leak.
Tamping Pins	The tamping pins are used to create the slug that is pushed into the body of the capsule before the cap is applied. Tamping pins might need replacing in the event of a hard stop or the product is seriously caustic or abrasive.
Tamping Pin Springs	The tamping pin springs are retained to the tamping pins. Over time these springs will go through a large amount of compressions and can lose their ability to hold the pins in the tamping pin blocks, which can affect capsule weights and protection in the event of a jam.
Dosing Disc Wear Ring	As the dosing disc rotates to create the slugs, it turns over the wear ring. This part is not only designed to help facilitate the movement of the Tamping Station, but also gives a flat surface for the slug to be formed against. Because of these two functions, the dosing disc will wear down over time.
Spacing Washer	The spacing washer calibrates the tamping pins. While it is unlikely that the spacing washer will need to be replaced due to damage, it is possible that it can be lost during cleaning or a machine strip down.
Capsule Ejection Springs	The capsule ejection springs are used to direct the capsules as they are pushed out of the machine. Sometimes they can become bent during cleaning or maintenance.

## Tooling

If you want to change the size of a capsule, it is necessary to change the Tooling.

To buy new Tooling from LFA, simply go to <https://www.lfacapsulefillers.com/fac-range-plates-moulds-set>

To watch a video of an FACP® Range Tooling change, go to <https://www.lfacapsulefillers.com/videos/fac-capsule-filler-tooling-change>

### Tools and Materials Needed

- Set of metric Allen keys with ball ends
- Metric wrench set
- New Tooling
- Tooling Calibration Set from FACP® Range Toolkit
- Permanent marker
- Crosshead screwdriver
- Empty capsules suited for new Tooling
- Disposable latex/rubber gloves (for food grade products and to protect hands from grease)
- Hairnet and/or beard net (food grade products only)
- Sterile shoe covers (food grade products only)



**WARNING:** To prevent any potential personal injury, ALWAYS unplug the FACP® from the electrical outlet when replacing parts.

### Instructions

Note: Wear latex/rubber gloves (and appropriate food grade attire if applicable) during this process.

#### Part One: Changing the Capsule Die Segments

1. Open the Perspex Casing's doors.
2. Remove the two bolts and small metal plate at the top of the Capsule Closing Plate with a wrench.

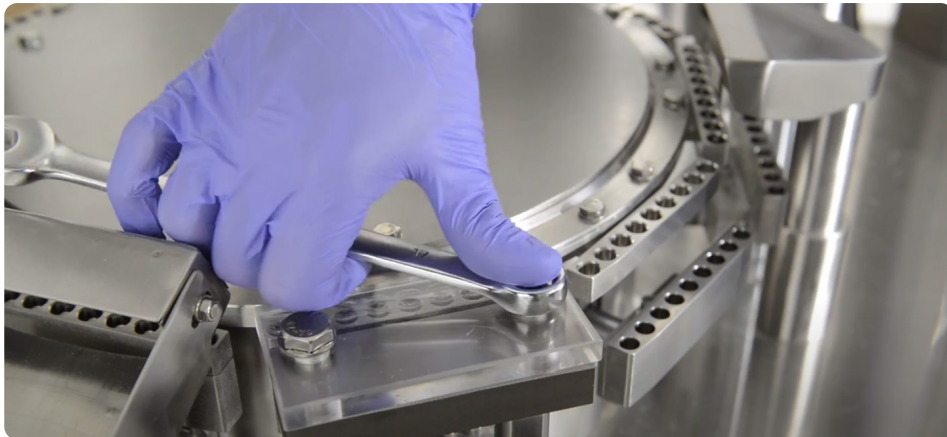

3. Remove the top section of the Tooling's two bolts with a wrench.

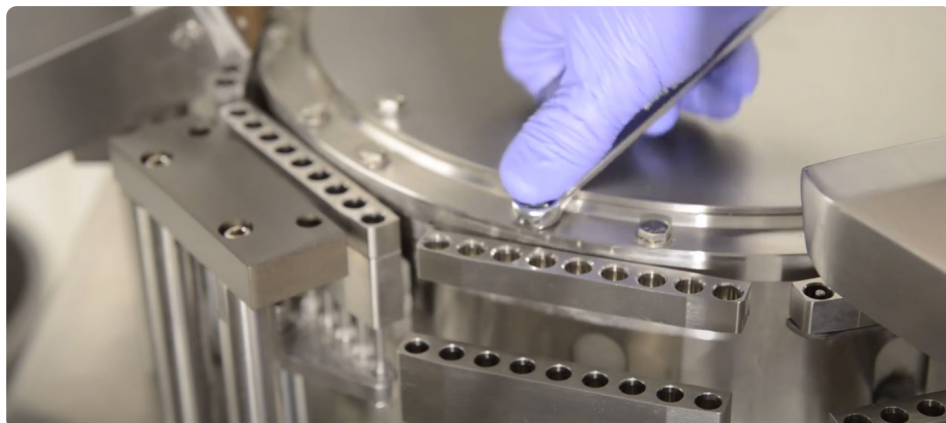

4. Take off the top section of the Tooling and set aside.



5. Remove the bolt behind the bottom section of the Tooling with an Allen key.



6. Take off the bottom section of the Tooling and set aside.



7. Manually operate machine until the next set of the Tooling sections are accessible.

8. Repeat steps 2-7 until all Tooling sections are removed.

9. Insert one of the new bottom sections of Tooling onto the Turret and tighten its bolt with an Allen key.

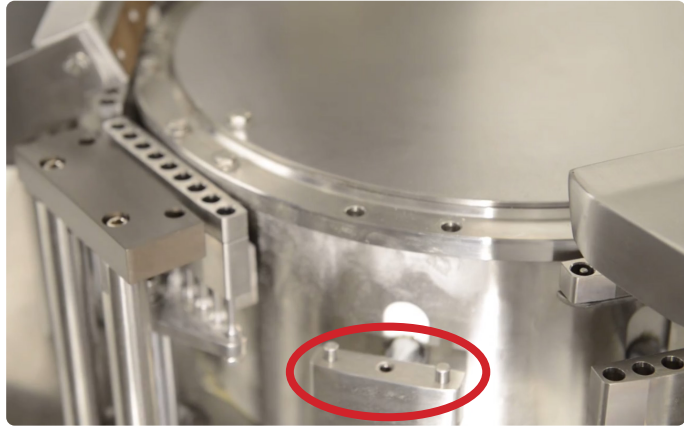

10. Place one of the new top sections of the Tooling under the lip of the Turret chamfer side up and loosely tighten its bolts by hand.

10.1 Note: The bolts should be finger tight so that the new top section can still move.



11. Rotate the machine so that the new Tooling is at the next station.

12. Insert the alignment tools from the Tooling Calibration Set into the two end slots of the Tooling.



13. Tighten the new top section of the Tooling with a wrench with the alignment tools still in place.

13.1 Note: Tighten the bolts slowly and in small increments. While tightening, occasionally lift the Alignment Tools and rotate them inside the new Tooling to ensure they are in the correct position.



14. Repeat steps 9-13 until all of the new Tooling sections are installed.
15. Place the metal plate and Capsule Closing Plate back onto the Turret.
  - 15.1 Note: Ensure that the chamfered edge is facing down and the Capsule Closing Plate is covering the Tooling.



16. Tighten the Capsule Closing Plate's bolts finger tight first, then equally tight with a wrench.



### Part Two: Capsule Sewing Section

17. Turn the Capsule Hopper door's knob counterclockwise to loosen it.
  - 17.1 Note: The door will fall down and prevent capsules from falling out.





18. Remove the Capsule Hopper by loosening its two bolts with an Allen key.

18.1 Note: Remove the Capsule Hopper carefully to not damage the Capsule Magazine edge.

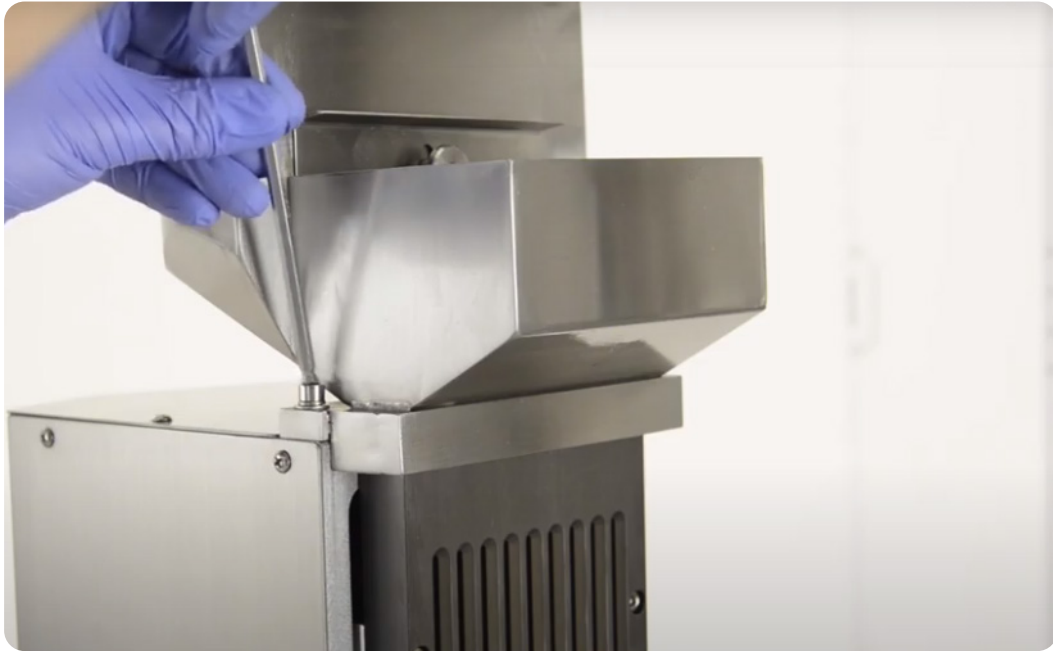

19. Remove the front section of the Capsule Magazine with an Allen key.

19.1 Note: Keep a hold of the front section to ensure it does not fall.

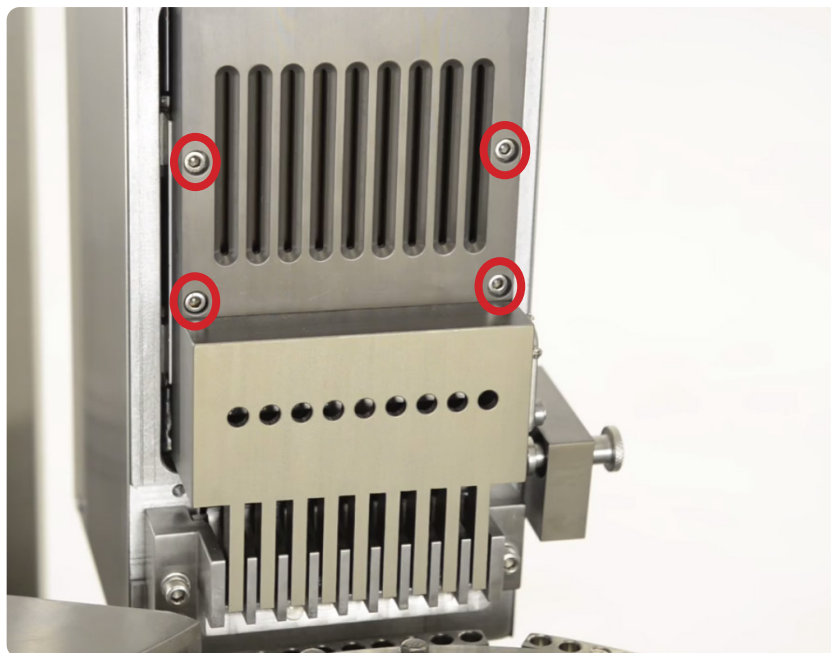

20. Remove the Capsule Magazine's teeth with an Allen key.

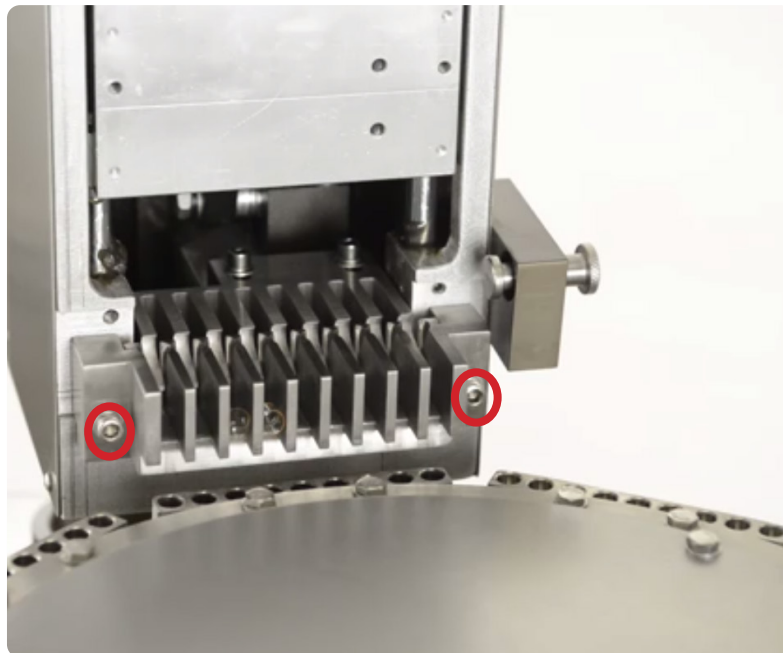

21. Trace the washers on the mounting block with a permanent marker.

21.1 Note: This is to mark their position so the mounting block can be attached correctly.



22. Remove the mounting block with an Allen key.

23. Remove the screws on either side of the Capsule Sewing Station with a crosshead screwdriver and remove the panel.

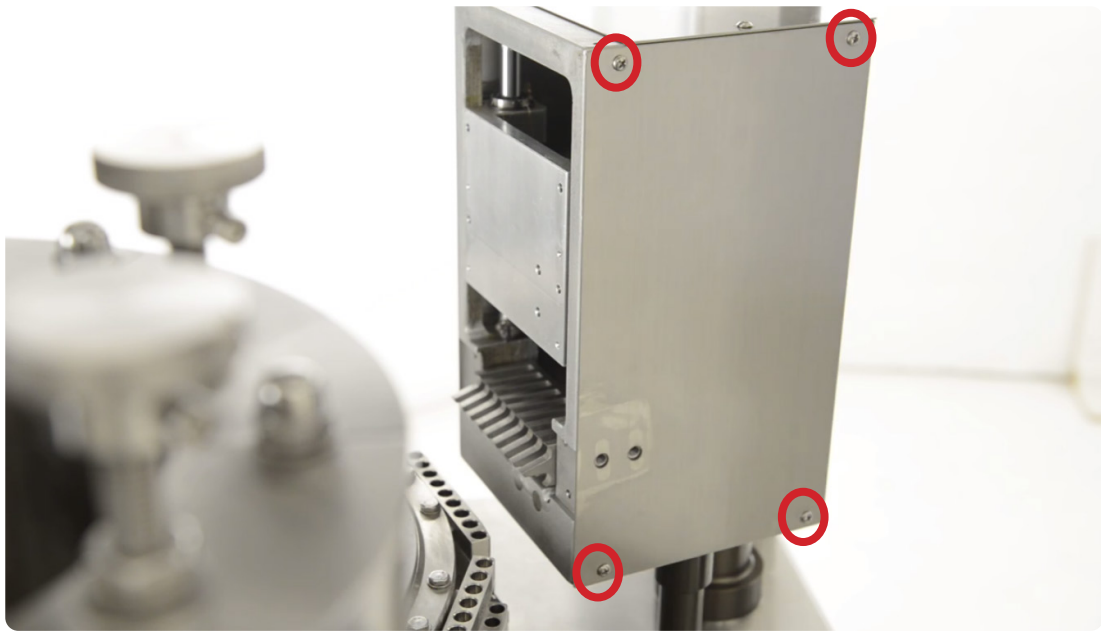

24. Remove the Capsule Magazine's back teeth with an Allen key.

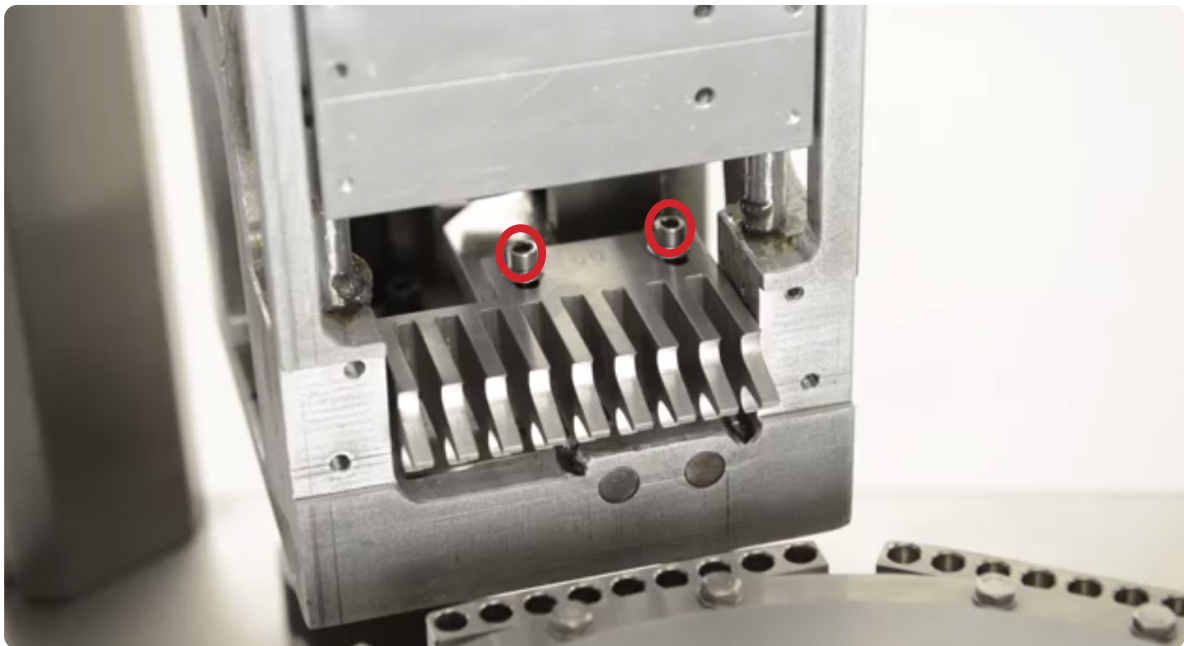

25. Insert the new back teeth onto the Capsule Magazine and tighten its bolts with an Allen key.

25.1 Note: The bolts should be finger tight so that the new back teeth can still move.

26. Insert the new front teeth into the new back teeth and tighten its side bolts with an Allen key.  
26.1 Note: The bolts should be finger tight so that the new front teeth can still move.



27. Insert the alignment tools from the Tooling Calibration Set in the two ends of the new front and back teeth.

27.1 Note: Ensure that the thicker end of the alignment tools goes into capsule bores first.

28. Adjust the new front and back teeth according to the alignment tools.



29. Tighten the new front teeth's bolts in equal increments with an Allen key.

29.1 Note: The alignment tools should still be in place while tightening to ensure correct adjustment.



30. Remove the alignment tools from the new front and back teeth.

31. Manually operate the machine so that the new back teeth move the furthest forward in their cycle.

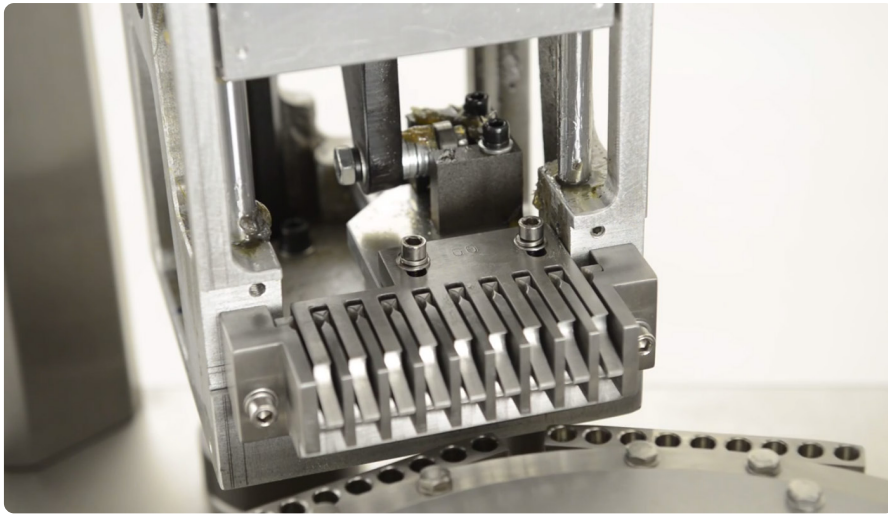

32. Insert two empty capsules cap first into the two end slots of the new front and back teeth.

32.1 Note: Ensure that the capsule cap ends are aligned with the new front teeth and that the new front and back teeth are not touching each other.

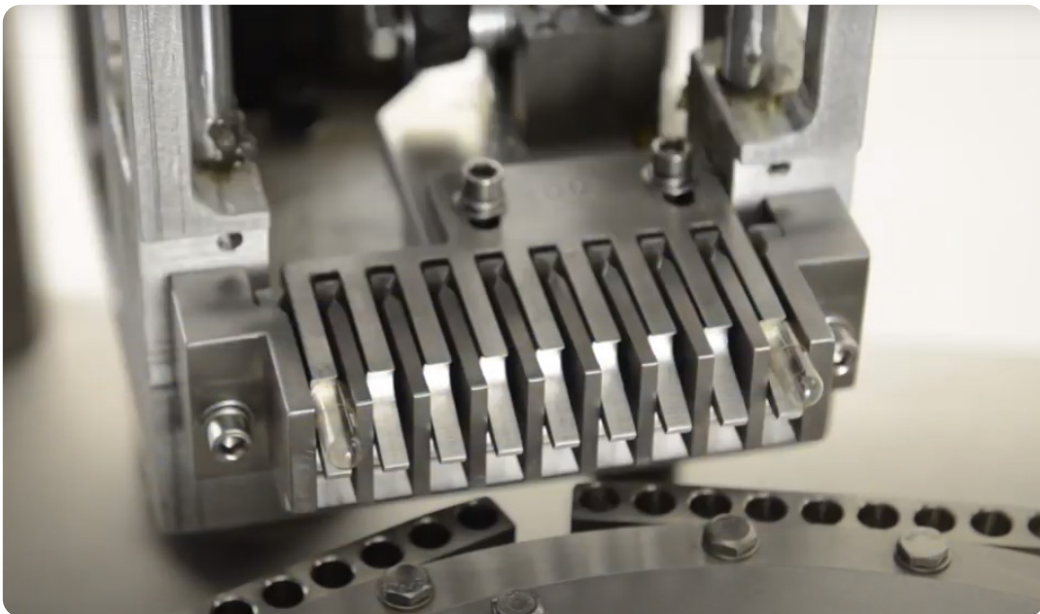

33. Tighten the new back teeth's bolts with an Allen key in equal and small increments.

33.1 Note: Ensure that the capsules are still aligned while tightening.

34. Manually operate the machine for one rotation.

34.1 Note: If any squeaking or metal-on-metal contact occurs, readjust the new front and back teeth.

35. Insert the new front section of the Capsule Magazine into the new front and back teeth.
36. Loosely tighten the new front section's four bolts to the Capsule Magazine with an Allen key.



37. Manually operate the machine until the new front section of the Capsule Magazine drops down to its lowest position.



38. Ensure that the gaps between the new front section and the new front and back teeth have sufficient space and are not causing any metal-on-metal contact.
39. Fully tighten the new front section's four bolts to the Capsule Magazine.
40. Manually operate the machine one more time to ensure that there is no metal-on-metal contact.



41. Insert the side panels back onto the Capsule Sewing Station and tighten their screws with a crosshead screwdriver.
42. Insert empty capsules into the top of the new front section of the Capsule Magazine.



43. Manually rotate the machine so that the new front section of the Capsule Magazine is at its highest point.

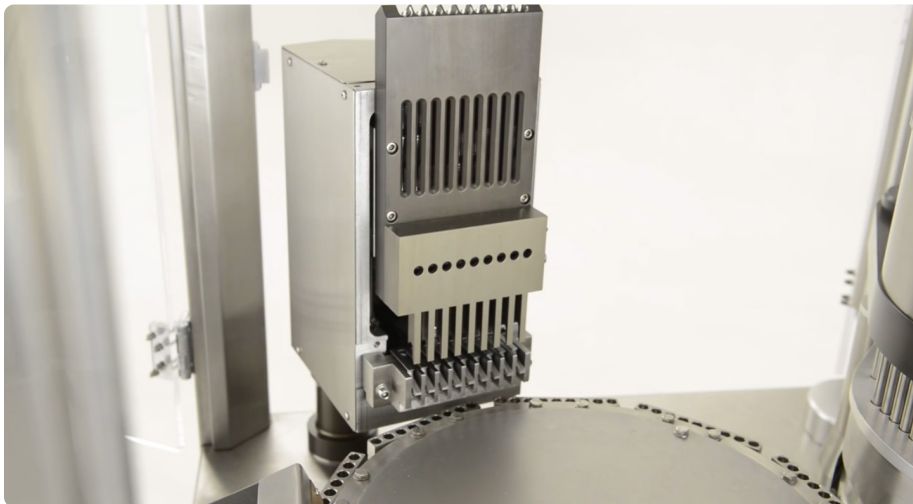

44. Reinstall the mounting block on the side of the Capsule Magazine with an Allen key.  
44.1 Note: Use the markings made earlier to ensure that it is in the correct position.



45. Press in the capsule release pin.

45.1 Note: Check that the gate is positioned correctly and release the capsules before moving on to the next step.



46. Lower the Capsule Hopper onto the new Capsule Magazine.

46.1 Note: Lower the Capsule Hopper carefully and gently to avoid damaging the Capsule Magazine.



47. Tighten the Capsule Hopper's bolts with an Allen key.



48. Manually rotate the machine one more time to ensure there is no metal-on-metal scraping.

### Part Three: Changing the Tamping Turret

49. Loosen the bolt on the pillar that holds the Powder Hopper and Powder Auger with a wrench.

50. Raise the pillar that holds the Powder Hopper and Powder Auger and re-tighten the bolt with a wrench.



51. Loosen the three bolts underneath the top section with an Allen key.



52. Loosen the bolt with an Allen key and lower the Powder Hopper.

52.1 Note: More than one person should be involved in this step to prevent the Powder Hopper from falling.



53. Remove the bolts on the top section's panel with an Allen key and remove it.



54. Remove the Auger Paddle's bolt with an Allen key and carefully lower the Powder Hopper.

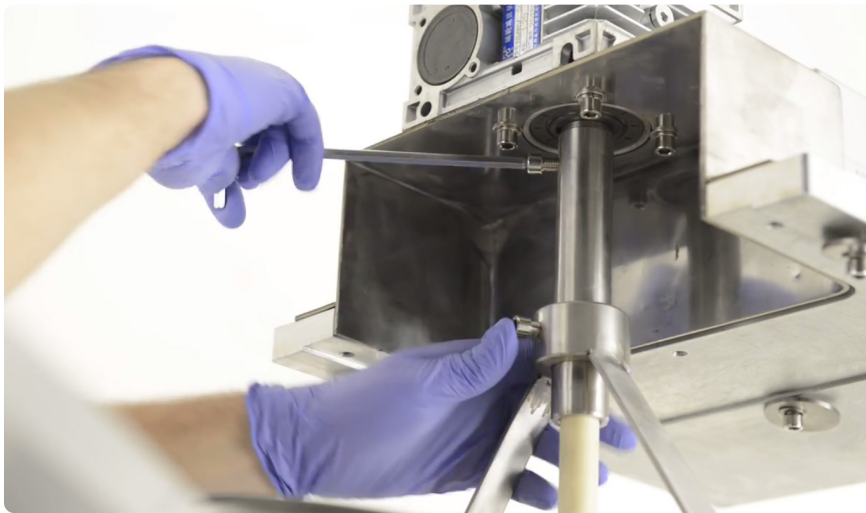

55. Rotate the top section away and remove the Powder Hopper.

55.1 Note: More than one person should be involved in this step to prevent the Powder Hopper from falling.





56. Pull out the sensor from the inside of the Tamping Turret.



57. Mark the following numbers on the stations:

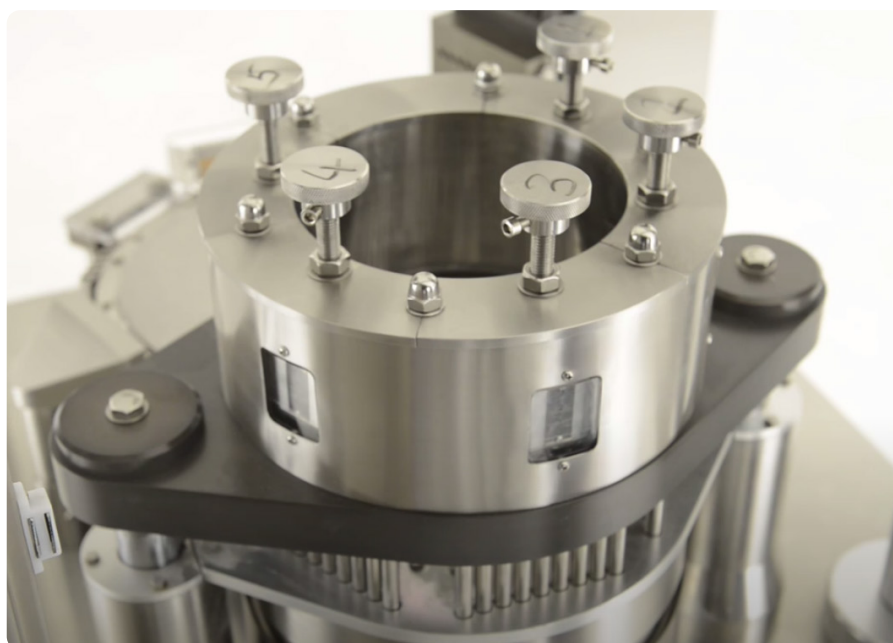

58. Remove the nuts and washers from the top of the Tamping Turret with a wrench.





59. Carefully pull up each station to remove the Tooling.

59.1 Note: Ensure not to damage the fragile ends of the Tamping Pins.



60. Lift up the extra panel, the inner metal casing, and outer metal casing and set aside.

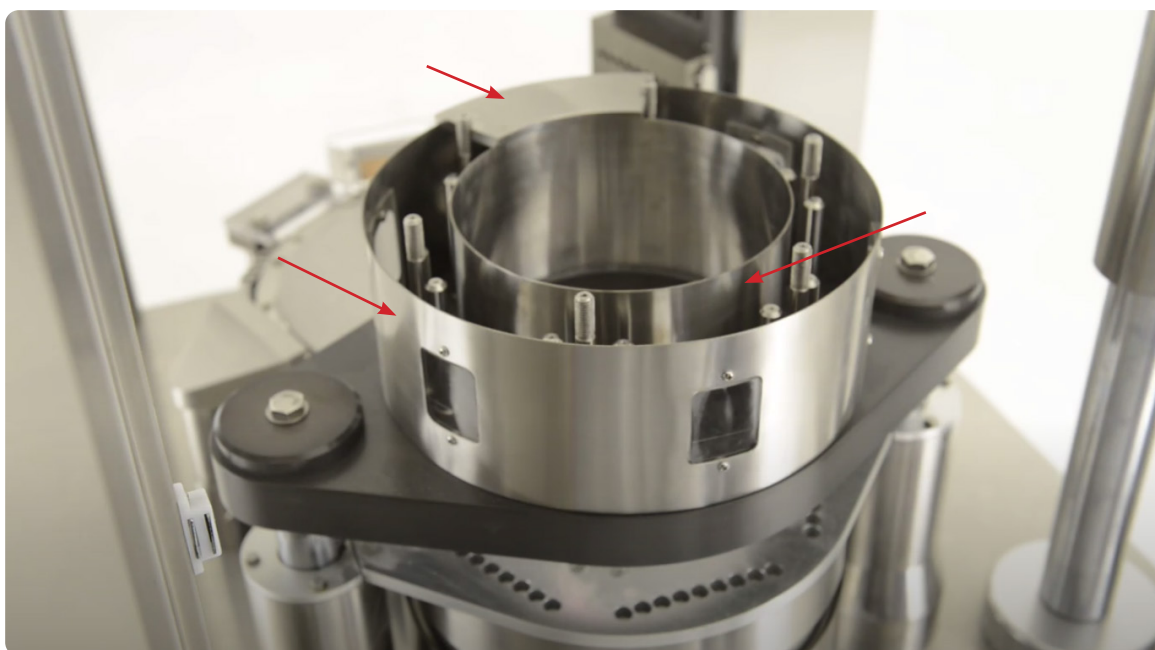

61. Remove the bolt with a wrench and carefully lift up the block.  
61.1 Note: Ensure not to lose the brass spacer.

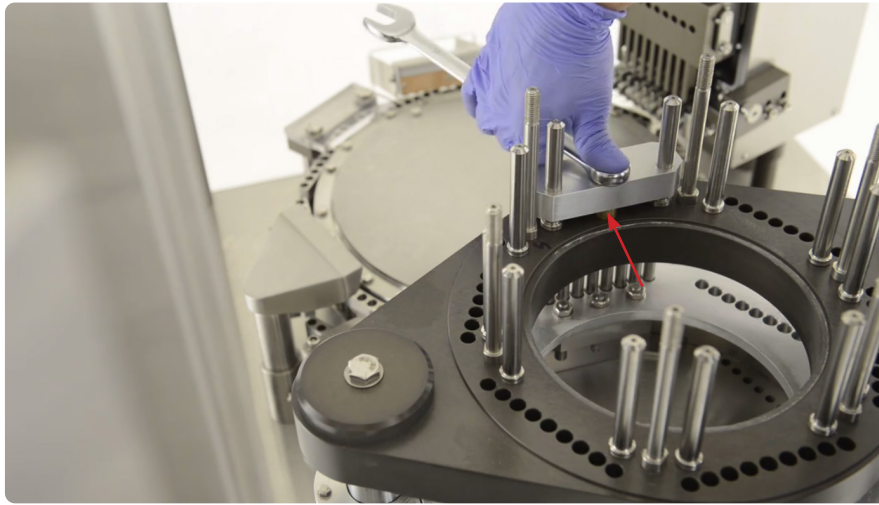

62. Remove both bolts from the sides and lift up the middle section of the Tamping Turret.

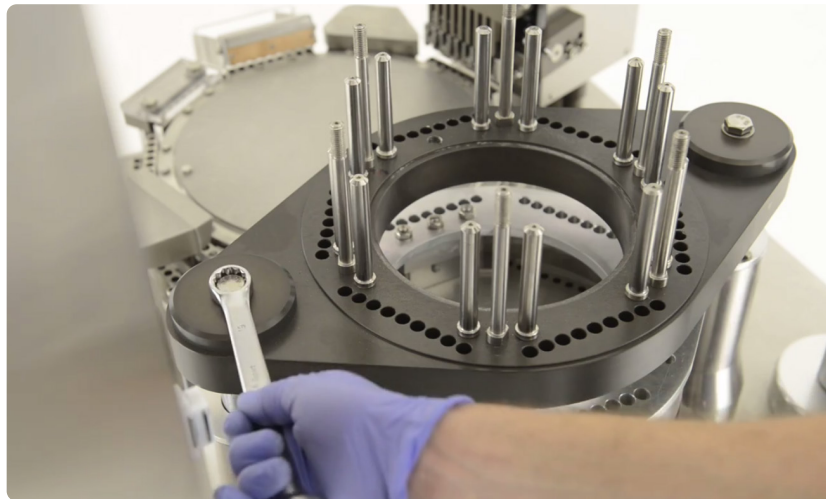

63. Remove the four bolts from the Tamping Pins Guide Runner with a wrench and lift it up.



64. Remove the bottom three bolts of the Tamping Bowl with the special tool included in the Toolkit.



65. Lift up and remove the bottom of the Tamping Turret.

66. Clean the bottom area of excess powder and inspect the brass ring for wear.





67. Place the new bottom of the Tamping Bowl onto the machine and loosely tighten the bolts.



68. Insert the new Tamping Pins Guide Runner onto the new bottom plate.

68.1 Note: Ensure that the sensor holder is facing outwards.



69. Fully tighten the four bolts onto the new Dosing Plate of the Tamping Turret.

69.1 Note: Ensure to tighten in small and equal increments.

70. Insert the new middle section of the Tamping Turret onto the new middle plate.

70.1 Note: Ensure that the hole of the brass spacer is facing the main Turret.



71. Fully tighten the two bolts on the new middle section of the Tamping Turret.

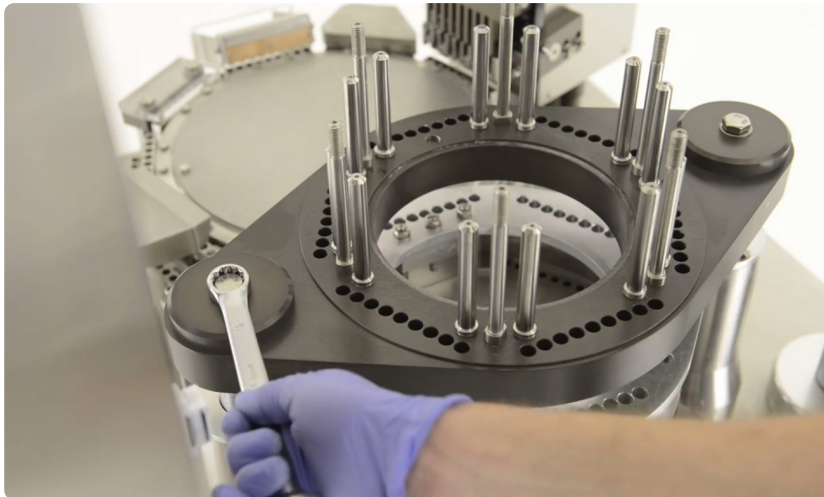

72. Manually rotate the machine until the Tamping Turret is at its lowest point.

73. Insert the alignment tools from the Tooling Calibration Set into the two ends of the Tamping Turret's new middle section and new Dosing Plate.



74. Adjust the new bottom of the Tamping Turret so that the alignment tools easily fall in the holes and are able to move freely.

75. Fully tighten the three bolts on the Tamping Bowl with the special tool included with the Toolkit.

75.1 Note: Ensure to tighten the bolts equally and in small increments.

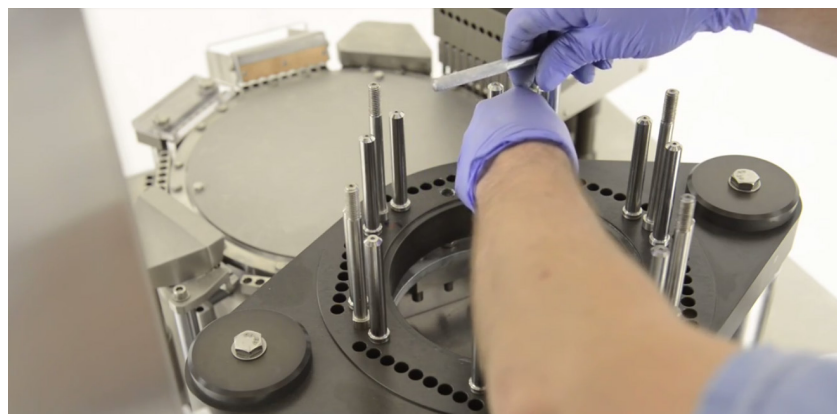



76. Check the alignment tools while tightening the new bottom of the Tamping Turret and make adjustments as necessary.

77. Remove the alignment tools.

78. Insert the capsule slug block into the Tamping Turret and place the brass spacer.

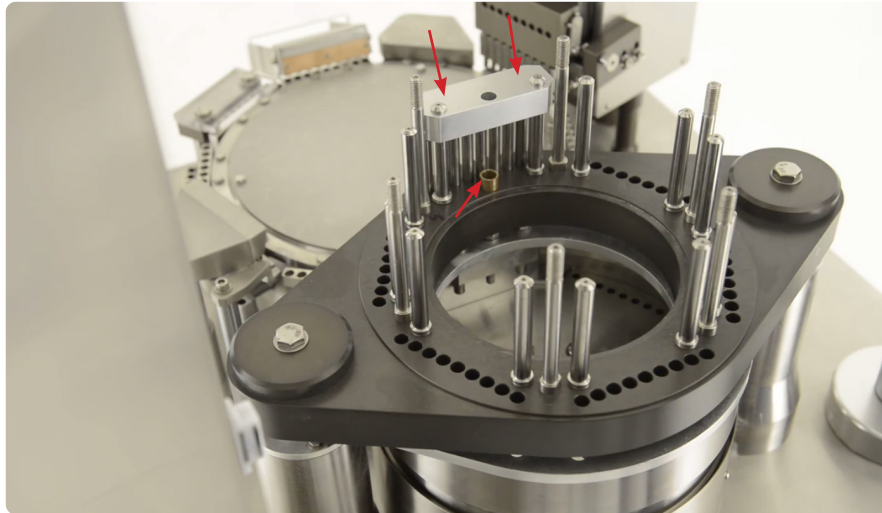

79. Push down on the block until it meets the brass spacer.

80. Tighten the block's bolt with a wrench.

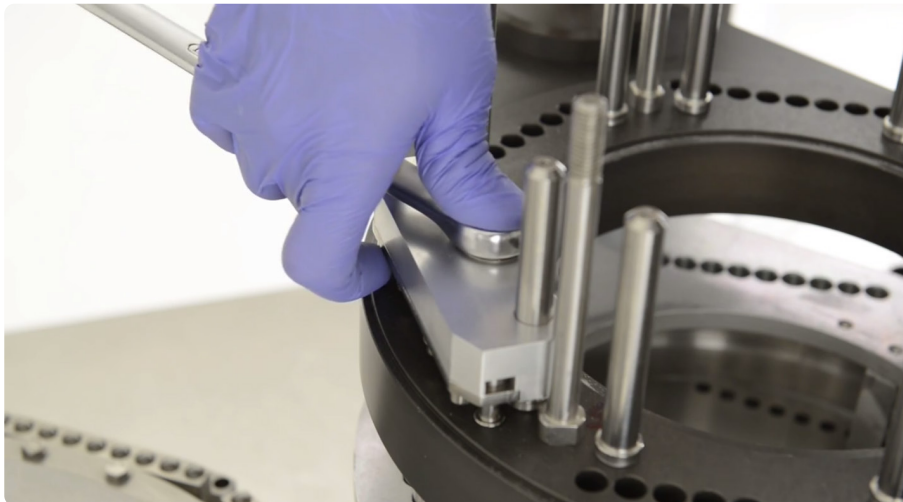

81. Insert the new inner metal casing and outer metal casing onto the Tamping Turret.

81.1 Note: The inner metal casing fits into a groove on the Tamping Turret. Ensure that the windows on the outer metal casing are each facing a station with the windowless area facing the main Turret.

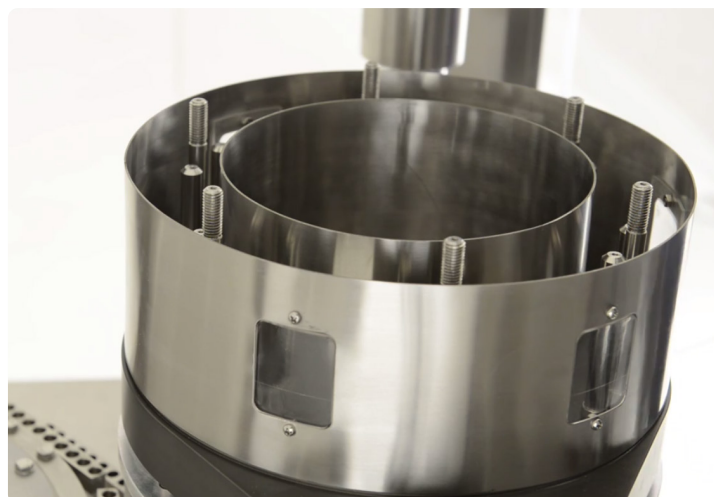

82. Insert each of the Tamping Pins into their appropriate stations in the Tamping Turret.  
82.1: Ensure not to damage the fragile ends.

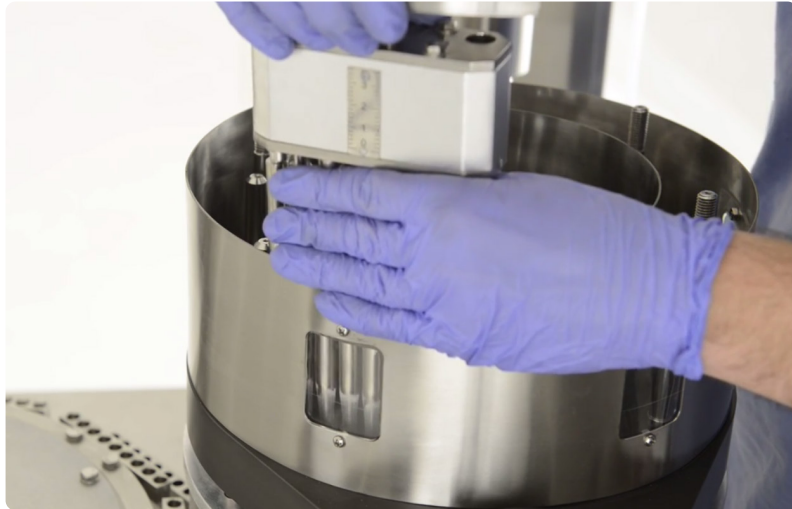

83. Tighten each of the bolts on top of the Tamping Turret with a wrench.  
83.1 Note: Ensure to tighten the bolts equally and in small increments.



84. Insert the sensor through the middle of the Tamping Turret and into its retainer.  
85. Reinsert the Powder Hopper gently.  
86. Rotate the top section back over the Powder Hopper.  
87. Reconnect the Auger Paddle with an Allen key.

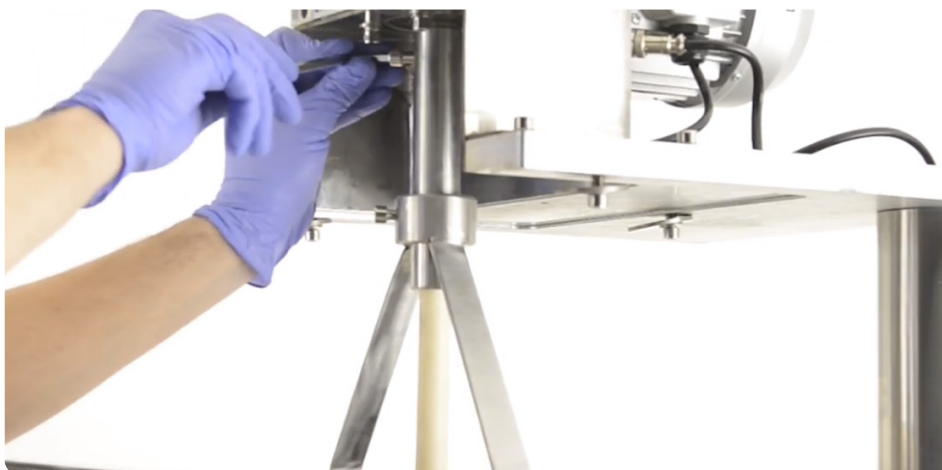

88. Raise the Powder Hopper into position and tighten its bolts with an Allen key.



89. Place the top section panel back and secure its bolts with an Allen key.



90. Loosen the top section's pillar with a wrench and lower it.

91. Tighten the top section's pillar once it is in the lowered position.



## Capsule Holding Pins

The Capsule Holding Pins hold the capsules in the Capsule Magazine and time their release. They can become damaged in the event of a jam, during cleaning, or if mishandled.

### Tools and Materials Needed

- Crosshead screwdriver
- Set of metric Allen keys with ball ends
- New Capsule Holding Pins
- Disposable latex/rubber gloves (for food grade products and to protect hands from grease)
- Hairnet and/or beard net (food grade products only)
- Sterile shoe covers (food grade products only)



**WARNING:** To prevent any potential personal injury, ALWAYS unplug the FACF® from the electrical outlet when replacing parts.

### Instructions

Note: Wear latex/rubber gloves (and appropriate food grade attire if applicable) during this process.

#### Remove the Capsule Hopper Pins

1. Turn the Capsule Hopper door's knob counterclockwise to loosen it.
  - 1.1 Note: The door will fall down and prevent capsules from falling out.



2. Remove the Capsule Hopper by loosening its two bolts with an Allen key.
  - 2.1 Note: Remove the Capsule Hopper carefully to not damage the Capsule Magazine edge.

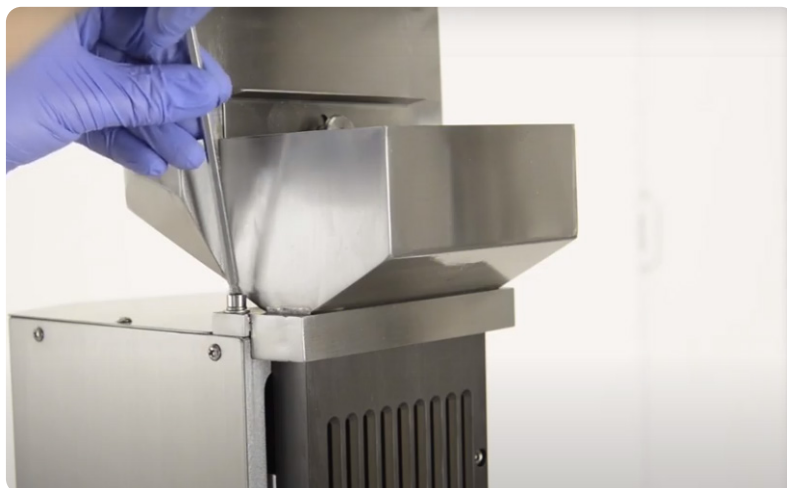



3. Remove the front section of the Capsule Magazine with an Allen key.
  - 3.1 Note: Keep a hold of the front section to ensure it does not fall.

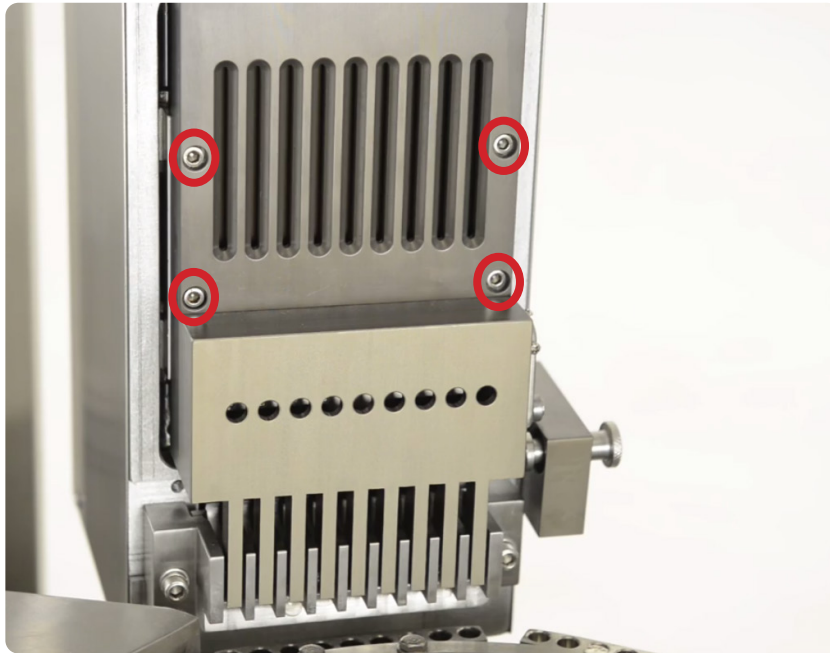

4. Remove the screws on the Capsule Magazine's back with a crosshead screwdriver.

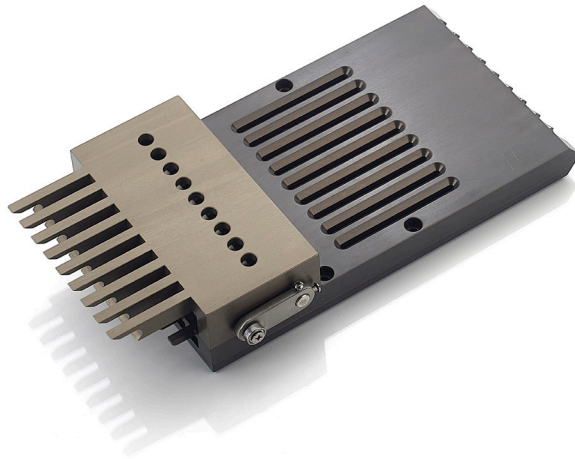

5. Remove each of the screws holding the Capsule Holding Pins with a crosshead screwdriver.

#### **Remove the Capsule Holding Pins**

6. Insert the new Capsule Holding Pins into place.
  - 6.1 Note: Ensure that all of the new Capsule Holding Pins are aligned.
7. Secure the new Capsule Holding Pins onto the Capsule Magazine with a crosshead screwdriver.
8. Tighten the side of the Capsule Magazine's screws with a crosshead screwdriver
9. Secure the front section of the Capsule Magazine's screws with an Allen key.
10. Reinsert the Capsule Hopper and tighten its two bolts with an Allen key.



## Dosing Disc Wear Ring

As the Dosing Disc rotates to create the powder slugs, it turns over the Dosing Disc Wear Ring. This part not only helps facilitates the Tamping Station's movement, but also gives a flat surface for the powder slugs to be formed against.

### Tools and Materials Needed

- Set of metric Allen keys with ball ends
- Metric wrench set
- New Dosing Disc Wear Ring
- Tooling Calibration Set from FACH® Range Toolkit
- Permanent marker
- Crosshead screwdriver
- Disposable latex/rubber gloves (for food grade products and to protect hands from grease)
- Hairnet and/or beard net (food grade products only)
- Sterile shoe covers (food grade products only)



**WARNING:** To prevent any potential personal injury, ALWAYS unplug the FACH® from the electrical outlet when replacing parts.

### Instructions

Note: Wear latex/rubber gloves (and appropriate food grade attire if applicable) during this process.

#### Remove the Dosing Disc Wear Ring

1. Loosen the bolt on the pillar that holds the Powder Hopper and Powder Auger with a wrench.
2. Raise the pillar that holds the Powder Hopper and Powder Auger and re-tighten the bolt with a wrench.



3. Loosen the three bolts underneath the top section with an Allen key.



4. Loosen the bolt with an Allen key and lower the Powder Hopper.

4.1 Note: More than one person should be involved in this step to prevent the Powder Hopper from falling.



5. Remove the bolts on the top section's panel with an Allen key and remove it.



6. Remove the Auger Paddle's bolt with an Allen key and carefully lower the Powder Hopper.

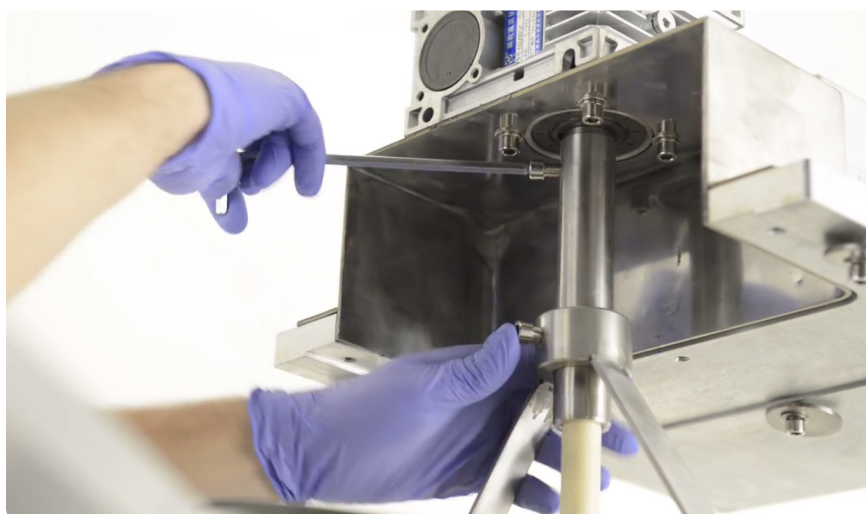

7. Rotate the top section away and remove the Powder Hopper.

7.1 Note: More than one person should be involved in this step to prevent the Powder Hopper from falling.



8. Pull out the sensor from the inside of the Tamping Turret.



9. Mark the following numbers on the stations:

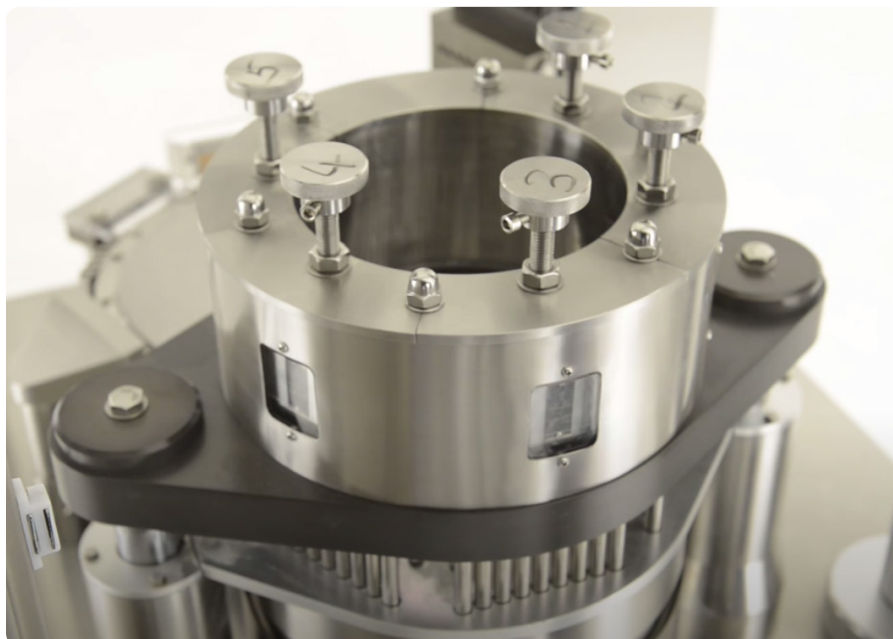

10. Remove the nuts and washers from the top of the Tamping Turret.



11. Carefully pull up each station to remove the Tooling.

11.1 Note: Ensure not to damage the fragile ends of the Tamping Pins.





12. Lift up the extra panel, the inner metal casing, and outer metal casing and set aside.

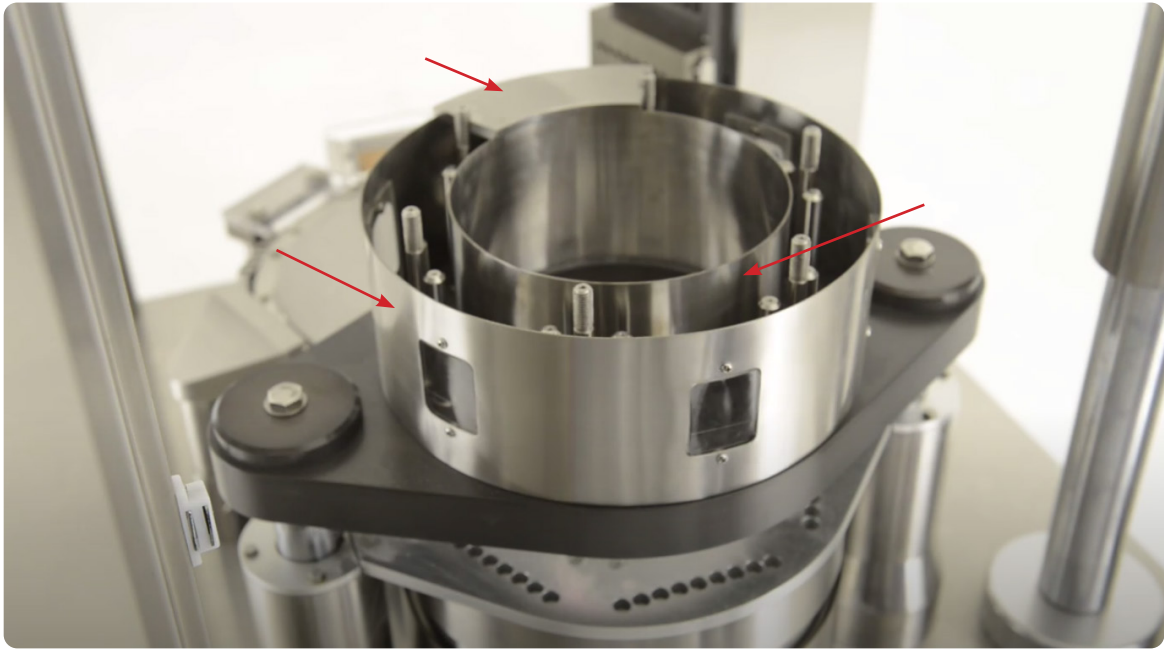

13. Remove the bolt with a wrench and carefully lift up the block.

13.1 Note: Ensure to not lose the brass spacer.



14. Remove both bolts from the sides and lift up the middle section of the Tamping Turret.





15. Remove the four bolts from the Dosing Disc with a wrench and lift it up.

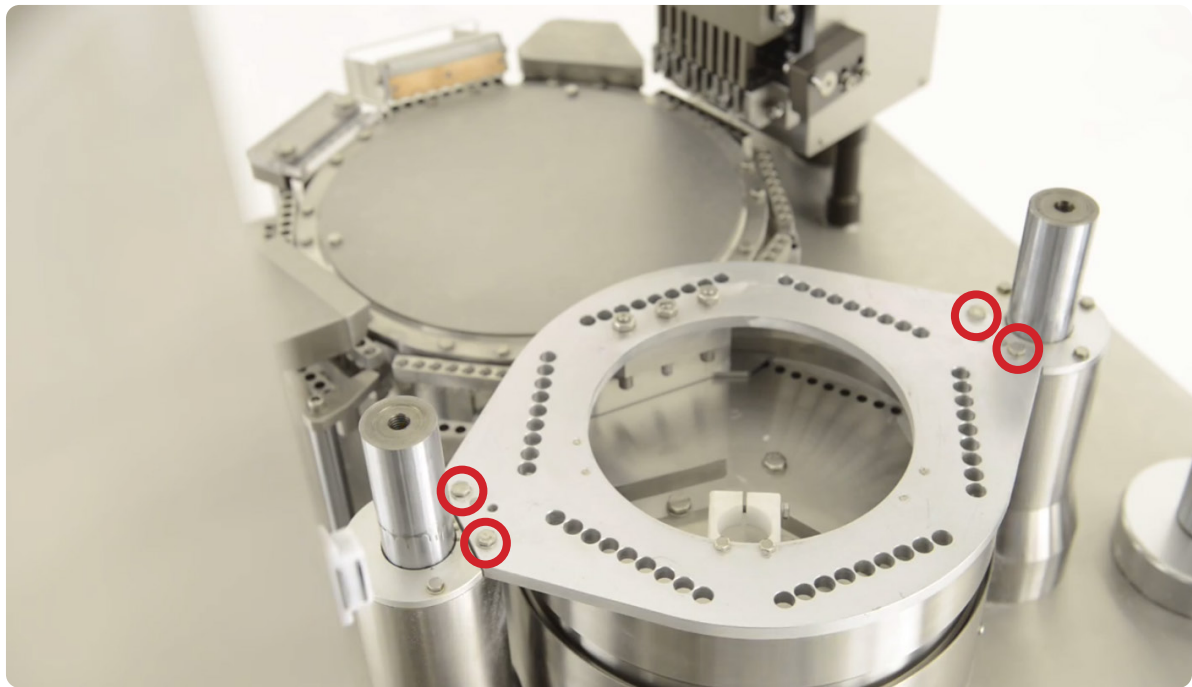

16. Remove the bottom three bolts of the Tamping Bowl with the special tool included in the Toolkit.



17. Lift up and remove the bottom of the Tamping Turret.
18. Remove the brass Dosing Disc Wear Ring from the machine.



#### **Replace the Dosing Disc Wear Ring**

19. Insert the new Dosing Disc Wear Ring onto the bottom of the Tamping Turret.
20. Reinsert the bottom of the Tamping Turret and resecure its three bolts with the special tool included in the Toolkit.
21. Reattach the Dosing Disc by screwing in its four bolts with a wrench.
22. Reattach the middle section of the Tamping Turret by screwing in its two bolts with a wrench.
23. Reinsert the block and reattach its bolt with a wrench.
24. Reinsert the inner metal casing, the outer metal casing, and extra panel.
25. Insert each of the Tamping Pins into their appropriate stations in the Tamping Turret.
  - 25.1: Ensure not to damage the fragile ends.

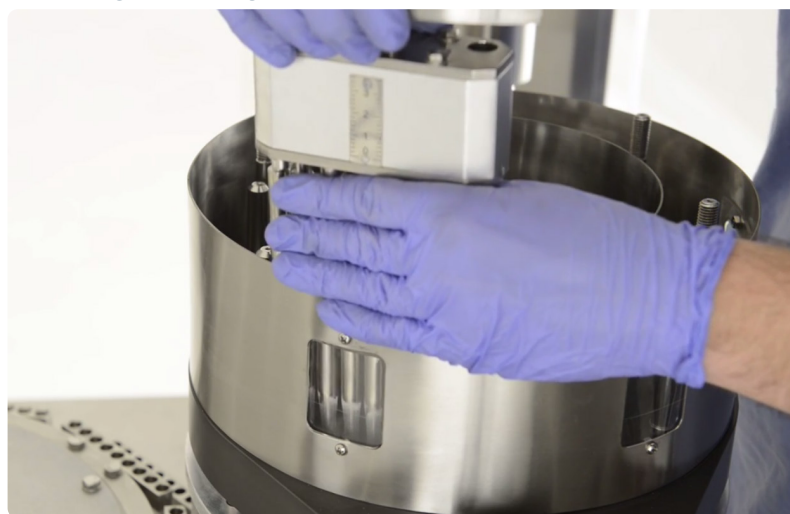

26. Tighten each of the bolts on top of the Tamping Turret with a wrench.  
26.1 Note: Ensure to tighten the bolts equally and in small increments.



27. Insert the sensor through the middle of the Tamping Turret and into its slotted area.
28. Reinsert the Powder Hopper gently.
29. Rotate the top section back over the Powder Hopper.
30. Reconnect the Auger Paddle with an Allen key.

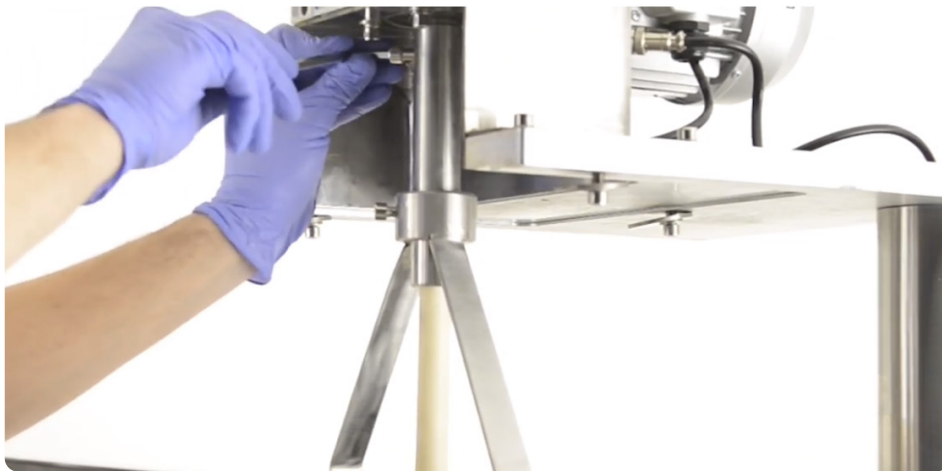

31. Raise the Powder Hopper into position and tighten its bolts with an Allen key.



32. Place the top section panel back and secure its bolts with an Allen key.



33. Loosen the top section's pillar with a wrench and lower it.

34. Tighten the top section's pillar once it is in the lowered position.





## Brass Spacer

The Brass Spacer calibrates the set of Tamping Pins that are used to push the slugs into the capsule bodies. Although it is unlikely this part will be worn down or broken, it is very easy to lose during cleaning and/or maintenance.

### Tools and Materials Needed

- Set of metric Allen keys with ball ends
- Metric wrench set
- New Dosing Disc Wear Ring
- Tooling Calibration Set from FACF® Range Toolkit
- Permanent marker
- Crosshead screwdriver
- Disposable latex/rubber gloves (for food grade products and to protect hands from grease)
- Hairnet and/or beard net (food grade products only)
- Sterile shoe covers (food grade products only)



**WARNING:** To prevent any potential personal injury, ALWAYS unplug the FACF® from the electrical outlet when replacing parts.

### Instructions

Note: Wear latex/rubber gloves (and appropriate food grade attire if applicable) during this process.

#### Replace the Dosing Disc Wear Ring

1. Loosen the bolt on the pillar that holds the Powder Hopper and Powder Auger with a wrench.
2. Raise the pillar that holds the Powder Hopper and Powder Auger and re-tighten the bolt with a wrench.



3. Loosen the three bolts underneath the top section with an Allen key.



4. Loosen the bolt with an Allen key and lower the Powder Hopper.

4.1 Note: More than one person should be involved in this step to prevent the Powder Hopper from falling.



5. Remove the bolts on the top section's panel with an Allen key and remove it.



6. Remove the Auger Paddle's bolt with an Allen key and carefully lower the Powder Hopper.

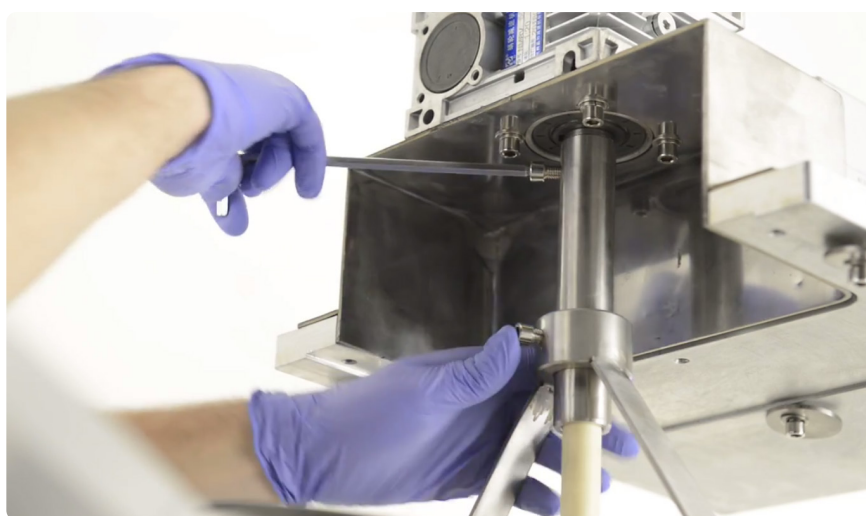

7. Rotate the top section away and remove the Powder Hopper.

7.1 Note: More than one person should be involved in this step to prevent the Powder Hopper from falling.



8. Pull out the sensor from the inside of the Tamping Turret.



9. Mark the following numbers on the stations:

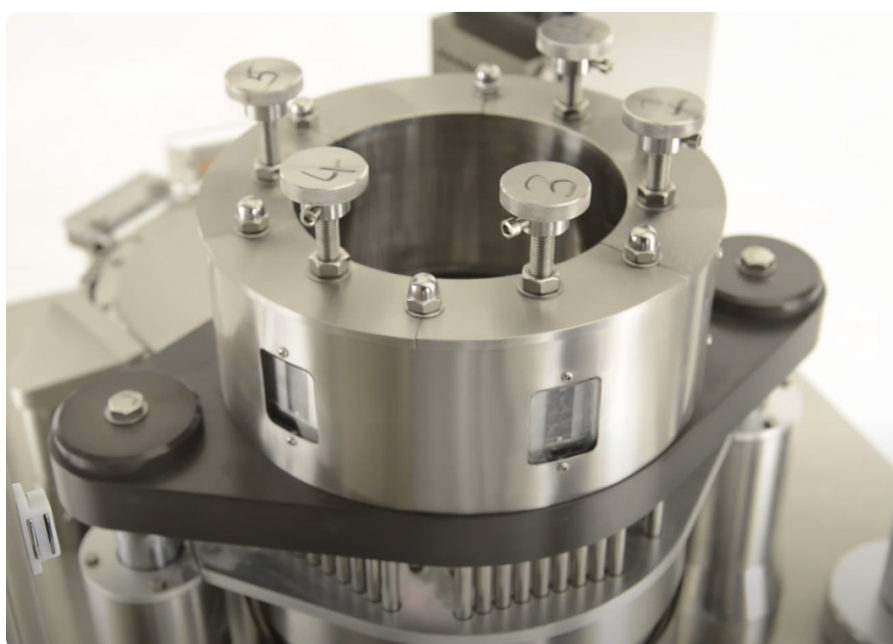



10. Remove the nuts and washers from the top of the Tamping Turret.



11. Carefully pull up all stations.

11.1 Note: Ensure not to damage the fragile ends of the Tamping Pins.



12. Lift up the extra panel, the inner metal casing, and outer metal casing and set aside.

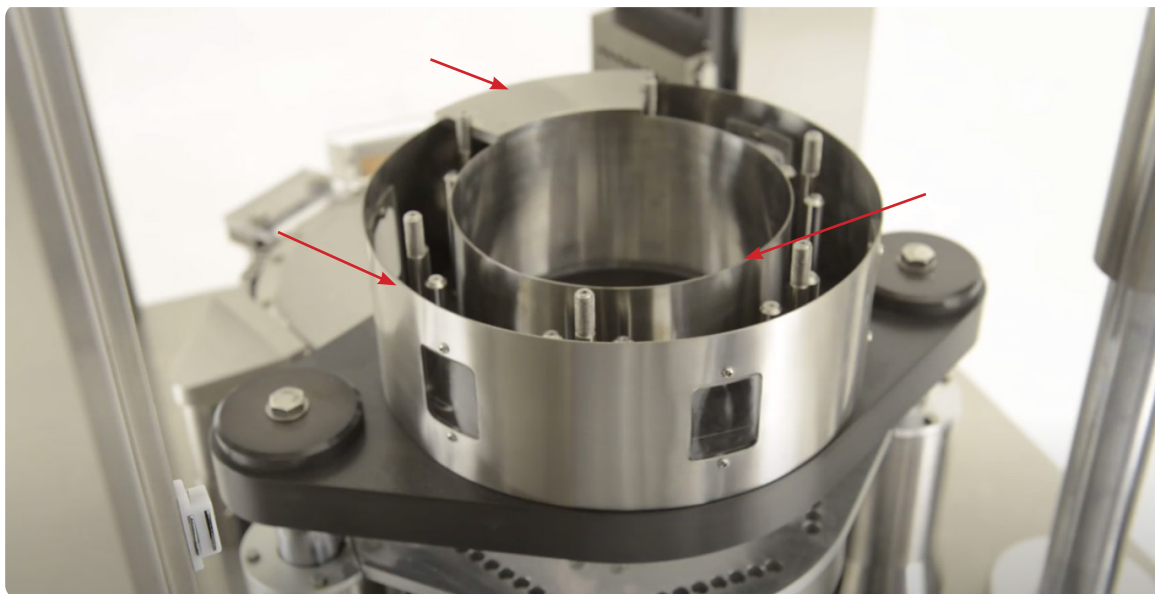



13. Loosen the block's bolt with a wrench.

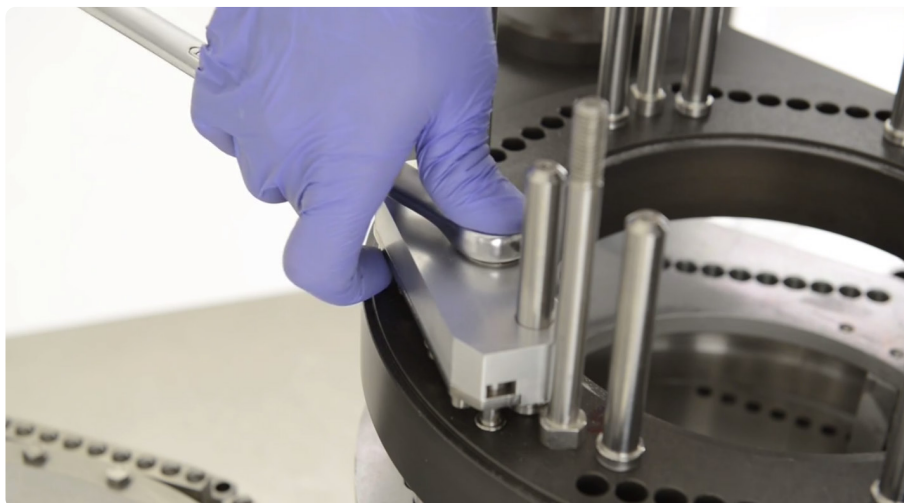

14. Raise the block to make room for the new Brass Spacer.



15. Place the new Brass Spacer on top of the bore.



- 16. Push down on the block until it meets the Brass Spacer.
- 17. Tighten the block's bolt with a wrench.

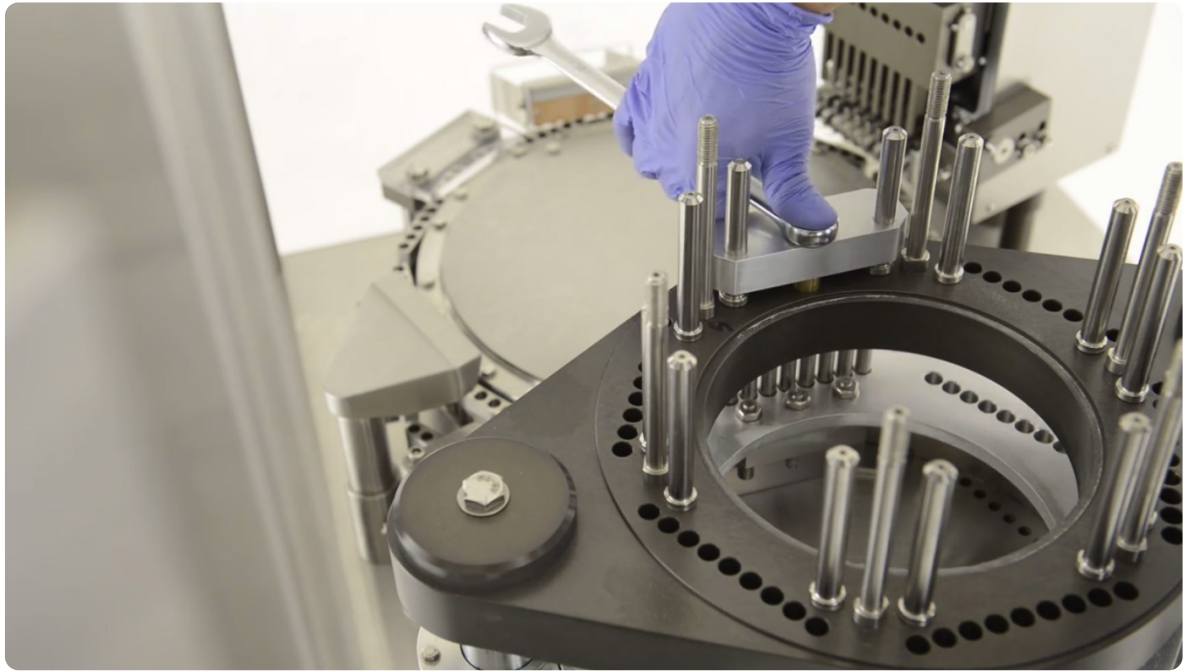

- 18. Reinsert the inner metal casing, the outer metal casing, and extra panel.
- 19. Insert each of the Tamping Pins into their appropriate stations in the Tamping Turret.
  - 19.1: Ensure not to damage the fragile ends.

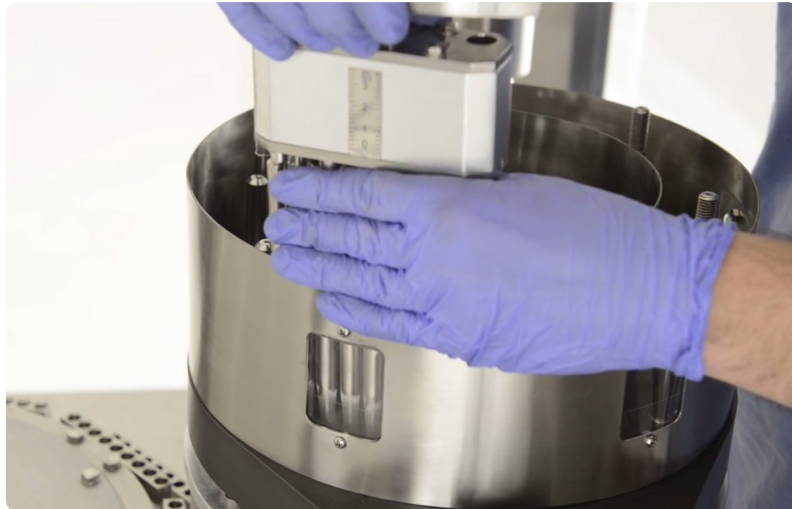

- 20. Tighten each of the bolts on top of the Tamping Turret with a wrench.
  - 20.1 Note: Ensure to tighten the bolts equally and in small increments.



21. Insert the sensor through the middle of the Tamping Turret and into its slotted area.
22. Reinsert the Powder Hopper gently.
23. Rotate the top section back over the Powder Hopper.
24. Reconnect the Auger Paddle with an Allen key.

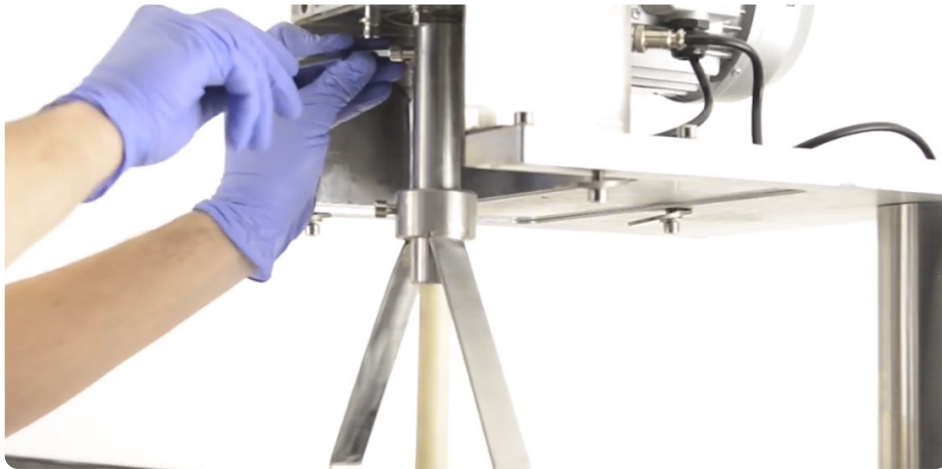

25. Raise the Powder Hopper into position and tighten its bolts with an Allen key.



26. Place the top section panel back and secure its bolts with an Allen key.



27. Loosen the top section's pillar with a wrench and lower it.
28. Tighten the top section's pillar once it is in the lowered position.

# Troubleshooting

Sometimes unavoidable issues will occur while operating the FACF® range. Fortunately, there are several methods to remedy these issues.

## Common Issues

Symptom	Possible Cause	Possible Solution
<b>Blockage in Capsule Magazine</b>	The capsules are too big or deformed.	Ensure that the capsules fit the Capsule Magazine.
	The Capsule Magazine is jammed.	Clean the Capsule Magazine tracks.
	Something is stuck in the Capsule Magazine's tracks.	Use sandpaper to polish the tracks and/or clean the tracks.
<b>Capsule caps and bodies do not separate</b>	The upper and lower Capsule Die Segments are not in alignment.	Adjust the position of the segments with the alignment tools.
	The Capsule Die Segments are blocked.	Clean the segment holes.
	The vacuum pressure is not high enough, the pipe line is jammed, or there is an air leakage.	Ensure that the vacuum pressure is -0.06 Mpa. Check the vacuum pipes and clean the filter.
<b>The capsule's ends are being punched through</b>	The upper and lower Capsule Die Segments are not in alignment, or the Capsule Closing Plate is too high at the closing station.	Check the closing station and the alignment of the upper and lower Capsule Die Segments with the alignment tools.
	The Closing Pins' position is too high.	Adjust the height of the Pushing Rod.
<b>The machine suddenly stops while running</b>	The powder has run out.	Add more powder.
	The powder's exit is blocked.	Clear the powder's exit and remove any solids from the powder.
	Some parts of the mechanical gear may be loose or damaged, or the electric motor is overloaded.	Check the machine for any damaged or loose parts. If the electric motor is overloaded, repair and adjust accordingly.



## Common Issues Continued

Symptom	Possible Cause	Possible Solution
<b>No powder feeding during automatic operation</b>	The powder height sensor of the feeder motor is damaged.	Check the sensitivity of the sensor, clean its switch, and/or adjust the sensor.
	The electrics are bad.	Check the corresponding electric circuit by referring to the electrical diagrams found in the Appendix. Contact an electrician if damaged.
<b>Capsules are not closing</b>	The gap of the Capsule Closing Plate is too high.	Ensure that the gap is 0.2 mm-0.3 mm.
	The powder is too fluffy, so the powder slugs are too big for the capsules.	Granulate the powder.
<b>Filled capsules discharge unsmoothly</b>	The capsules contain static electricity.	If there are capsules stuck to the discharge chute, blow them off with an air compressor.
	There is a jam in the discharge chute.	Clean the discharge chute.
	The angle of the Capsule Closing Plate elevation is too high.	Adjust the screws to reduce the angle.

# De-Jamming the FACF<sup>®</sup> Range

There are a couple reasons why a FACF<sup>®</sup> might jam such as:

- Disfigured capsules become lodged in magazine tracks.
- Powder builds up.

The methods that can fix a jammed FACF<sup>®</sup> follow below:

## Tools and Materials Needed

- Set of metric Allen keys with ball ends
- Crosshead screwdriver
- Cleaner (e.g. Member's Mark Commercial Lemon Fresh Disinfectant)
- Sanitizer (e.g. Member's Mark Commercial Sanitizer)
- Bowl of warm soapy water (nothing abrasive)
- 3 clean cloths and a toothbrush
- Dry raw powder materials
- Disposable latex/rubber gloves (for food grade products and to protect hands from grease)
- Hairnet and/or beard net (food grade products only)
- Sterile shoe covers (food grade products only)



**WARNING:** To prevent any potential personal injury, ALWAYS unplug the FACF<sup>®</sup> before de-jamming it.

Note: Wear latex/rubber gloves (and appropriate food grade attire if applicable) during this process.

## Method 1: Dislodge Disfigured Capsules

1. Remove the Capsule Hopper and the Capsule Magazine with an Allen key.
  - 1.1 Note: Please refer to the remove and replace Capsule Holding Pins instructions on page 62 for further information.
2. Take apart the Capsule Magazine with an Allen key and remove any stuck/damaged capsules.
  - 2.1 Note: Please refer to the remove and replace Capsule Holding Pins instructions on page 62 for further information.

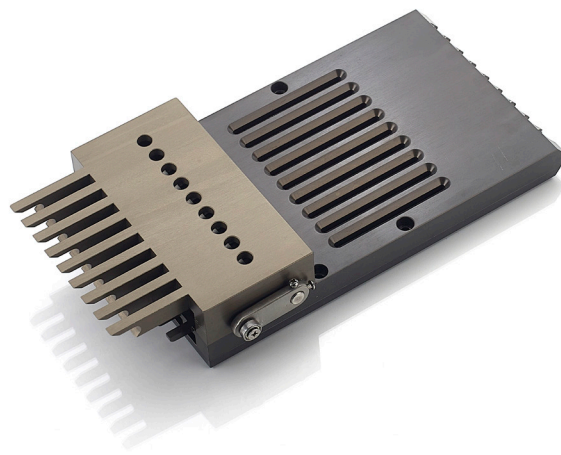

**Method 2: Clean Excess Powder Buildup**

1. Remove the Powder Hopper, Auger, and each part of the tamping Tooling.
  - 1.1 Note: Please refer to the remove and replace Tooling instructions on page 39 for further assistance.
2. Take one of the parts removed from the machine and bring it to the bowl of soapy water.
  - 2.1 Note: To ensure that all dirt and debris are removed, wash one part at a time.
3. Take a clean cloth and carefully wash the part thoroughly.
  - 3.1 Note: Use the toothbrush for difficult-to-remove debris. When cleaning Tooling, use non-abrasive cleaning equipment such as a soft pipe cleaner and soft cloth.
4. Dry part immediately after it is cleaned and rinsed.
5. Sanitize part with a clean cloth.
6. Repeat steps 2-5 for each remaining part until they are all clean.

# Cleaning

During the FACF®'s operation, excess powder will find its way into parts of the machine, particularly in the Capsule Magazine and Tamping Turret. It is important to clean the FACF® thoroughly to prevent rusting and cross contamination.

LFA recommends that the machine be cleaned after each operation.

## Tools and Materials Needed

- Cleaning brush/paintbrush
- Bagless vacuum
- Long wire pipe cleaner
- Toothbrush
- Cleaner (e.g. Member's Mark Commercial Lemon Fresh Disinfectant)
- Sanitizer (e.g. Member's Mark Commercial Sanitizer)
- Set of metric Allen keys with ball ends
- Crosshead screwdriver
- Disposable latex/rubber gloves
- Bowl of warm soapy water (nothing abrasive)
- 3 clean cloths
- Potable water
- Hairnet and/or beard net (food grade products only)
- Sterile shoe covers (food grade products only)



**WARNING:** To prevent any potential personal injury, ALWAYS unplug the FACF® from the electrical outlet when removing and replacing parts.

## Instructions

Note: Wear latex/rubber gloves (and appropriate food grade attire if applicable) during this process.

### Remove Parts

1. Remove the Capsule Hopper, Capsule Magazine, the Powder Hopper, the Auger, and the Tamping Disc station.
  - 1.1 Note: Please refer to the remove and replace Tooling instructions on page 39 for further information.
2. Take apart the Capsule Magazine.
  - 2.1 Note: Please refer to the remove and replace Capsule Holding Pins instructions on page 62 for further information.
3. Clean away any debris from inside the Capsule Magazine's tracks with a wire pipe cleaner.
4. Vacuum any excess powder from the bottom of the Tamping Turret and sanitize.

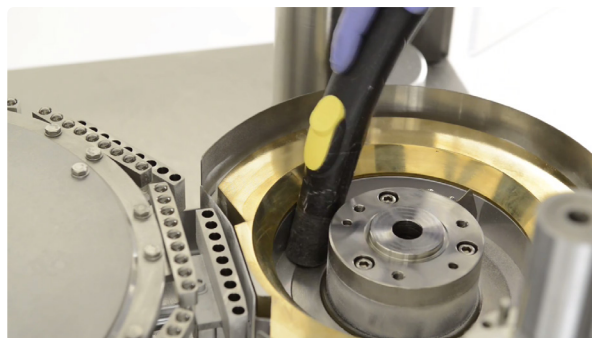



### Clean the Parts

5. Take one of the parts removed from the machine and bring it to the bowl of soapy water.  
5.1 Note: To ensure that all dirt and debris are removed, wash one part at a time.
6. Take a clean cloth and carefully wash the part thoroughly.  
6.1 Note: Use the toothbrush for difficult-to-remove debris. When cleaning Tooling, use non-abrasive cleaning equipment such as a soft pipe cleaner and soft cloth.
7. Dry part immediately after it is cleaned and rinsed.
8. Sanitize part with a clean cloth.
9. Repeat steps 5-8 for each remaining part until they are all clean.

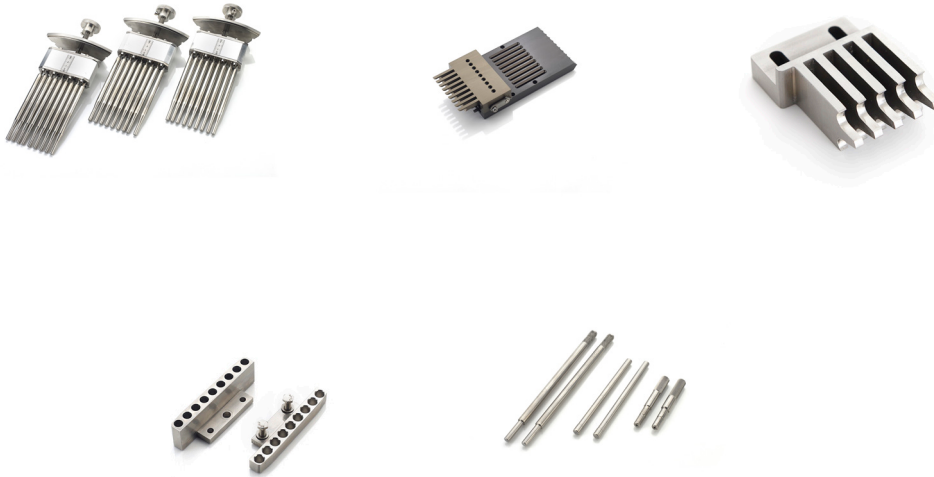

### Clean the External Area

10. Spray the FACF<sup>®</sup> external area with the cleaner, particularly in the location of the Capsule Die Segments, Capsule Magazine, and Tamping Turret.

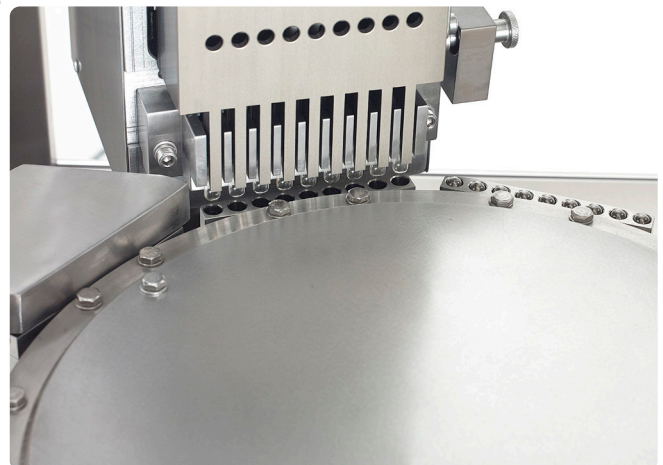

11. Rinse the cleaner off with potable water.
12. Sanitize the FACF<sup>®</sup> external area with a clean cloth.

## Cleaning Schedule Matrix

Part	After Installing Machine	After Every Use	Before Every Use	Inbetween Products That Present A Cross Contamination Risk	Weekly	Monthly	Before Placing In Storage	After Removing From Storage
Capsule Hopper	Wet clean and re-lubricate if specified in lubrication schedule	Dry clean and re-lubricate if specified in lubrication schedule	Dry clean and re-lubricate if specified in lubrication schedule	Wet clean and re-lubricate if specified in lubrication schedule	Dry clean and re-lubricate if specified in lubrication schedule	Wet clean and re-lubricate if specified in lubrication schedule	Dry clean and re-lubricate if specified in lubrication schedule	Wet clean and re-lubricate if specified in lubrication schedule
Powder Hopper	Wet clean and re-lubricate if specified in lubrication schedule	Wet clean and re-lubricate if specified in lubrication schedule	Wet clean and re-lubricate if specified in lubrication schedule	Wet clean and re-lubricate if specified in lubrication schedule	Wet clean and re-lubricate if specified in lubrication schedule	Wet clean and re-lubricate if specified in lubrication schedule	Wet clean and re-lubricate if specified in lubrication schedule	Wet clean and re-lubricate if specified in lubrication schedule
Base	Wet clean and re-lubricate if specified in lubrication schedule	Dry clean and re-lubricate if specified in lubrication schedule	Dry clean and re-lubricate if specified in lubrication schedule	Wet clean and re-lubricate if specified in lubrication schedule	Dry clean and re-lubricate if specified in lubrication schedule	Wet clean and re-lubricate if specified in lubrication schedule	Dry clean and re-lubricate if specified in lubrication schedule	Wet clean and re-lubricate if specified in lubrication schedule
Upper and Lower Sections of Capsule Closing Tooling	Wet clean and re-lubricate if specified in lubrication schedule	Wet clean and re-lubricate if specified in lubrication schedule	Wet clean and re-lubricate if specified in lubrication schedule	Wet clean and re-lubricate if specified in lubrication schedule	Wet clean and re-lubricate if specified in lubrication schedule	Wet clean and re-lubricate if specified in lubrication schedule	Wet clean and re-lubricate if specified in lubrication schedule	Wet clean and re-lubricate if specified in lubrication schedule
Capsule Magazine and Teeth	Wet clean and re-lubricate if specified in lubrication schedule	Dry clean and re-lubricate if specified in lubrication schedule	Dry clean and re-lubricate if specified in lubrication schedule	Wet clean and re-lubricate if specified in lubrication schedule	Wet clean and re-lubricate if specified in lubrication schedule	Wet clean and re-lubricate if specified in lubrication schedule	Dry clean and re-lubricate if specified in lubrication schedule	Wet clean and re-lubricate if specified in lubrication schedule
Tamping Turret and Stations	Wet clean and re-lubricate if specified in lubrication schedule	Dry clean with cloth	Wet clean and re-lubricate if specified in lubrication schedule	Wet clean and re-lubricate if specified in lubrication schedule	Dry clean with cloth	Wet clean and re-lubricate if specified in lubrication schedule	Dry clean with cloth	Wet clean and re-lubricate if specified in lubrication schedule

### Cleaning Level Key

Level 1 - Remove powder
Level 2 - Dry clean with cloth
Level 3 - Dry clean and re-lubricate if specified in lubrication schedule
Level 4 - Wet clean and re-lubricate if specified in lubrication schedule
<b>Remove from machine</b> - Take part out of machine and clean if required. Store it correctly or install back into machine.
<b>Install into machine</b> - Install part into the machine and make sure that it has been cleaned. If needed, lubricate to the level required.
<b>Clean on/in machine</b> - Clean the part while in the machine and do not remove it. Make sure that all contact surfaces are clean to the level required.

This cleaning matrix is intended as a guide only and is not an exhaustive list. All cleaning schedules will need to be adapted to the industry and product, following industry regulations and the material safety data sheets that come with specific products. Please check with your Food Safety Manager/Department, Quality Control Manager/Department, or other relevant internal departments at your company before using.

# Storing the FACF® Range

After its thorough cleaning, the FACF® needs to be stored in the proper conditions. It is important to store it in an environment in which the machine is safe from rusting. The FACF®'s high traction areas and the Tooling need to be lubricated separately before you store them.

## Tools and Materials Needed

- Plastic wrapping to cover machine
- Container(s) for Tooling (if in storage for more than a week)
- Lubricant/grease (NSF approved lubricant if machine has a high chance of contact with the food or drug product)
- Disposable latex/rubber gloves (for food grade products and to protect hands from lubricant)
- Hairnet and/or beard net (food grade products only)
- Sterile shoe covers (food grade products only)

## Instructions

Note: Wear latex/rubber gloves (and appropriate food grade attire if applicable) during this process.

### Lubricating the Tooling

If you are not using the machine for more than a week, store the Tooling in containers and cover it with lubricant to prevent rust formation. If not, simply lubricate each part of the Tooling and reinsert it back into the machine.

### Lubricating the Grease Points and High-Traction Parts

1. Apply one layer of grease onto the work surface of the cams and rollers.
  - 1.1 Note: To see drawings of lubrication point locations, please refer to the Lubrication Schedule on page 35.
2. Apply lubrication oil to joint bearings, sealing bearings, and sliding guides.
3. Grease the ball bearings, needle bearing, and linear bearings.
4. Check the driving chains' tightness and apply lubricant.
5. Replenish the oil of the main driving and feeder decelerators.

# Appendix

## Glossary

Term	Definition
API/Active Pharmaceutical Ingredient	Any substance or mixture of substances used that is an active ingredient in the drug product.
Capsule Closing Plate	Plastic part with a chamfered edge that is secured over the Tooling. The filled capsule halves are sealed against the Capsule Closing Plate.
Capsule Magazine	The unit in which the capsules are inserted and oriented. It also feeds the capsule halves into the Tooling.
Capsule Sewing Section	Area of machine in which the capsules are oriented and fed into the Tooling.
Excipient	A substance formulated alongside the API in the capsule powder.
Formulation	Powder mix of the excipient and the API that is used to fill capsules.
Megapascal (MPa)	The measure of force per unit area and defined as one newton per square meter.
Tamping Turret	Area of the machine in which powder slugs are formed and tamped into the capsule halves by the Tooling.
Tooling	Enables a fully automatic capsule filler to fill and seal capsules. The Tooling can be found in the Capsule Sewing Section, Tamping Turret, and Capsule Ejection Section.



## Description of FACF® Range Parts

### Filter Bag for Capsule Filler Vacuum Pump

The Filter Bag for the Capsule Filler Vacuum Pump catches dust and debris that come from the machine's operation. Order at <https://www.lfacapsulefillers.com/filer-bag-capsule-filler-vacuum-pump>

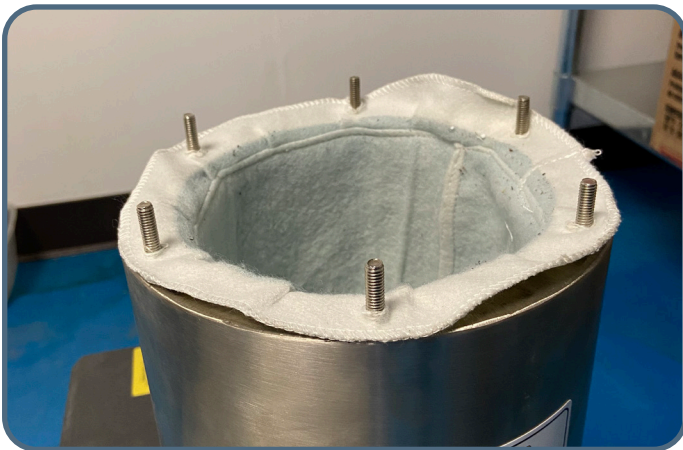

### Vacuum Bag for TabVac Dust Vacuum

The Vacuum Bag for the TabVac catches the excess powder dust generated by the capsule filler. Order at <https://www.lfacapsulefillers.com/vacuum-bag-tabvac-dust-vacuum>



### Tooling

The Tooling consists of the Tooling Plates, Molds, and Capsule Magazine. They all work as a set to fill the powder into capsules. Order at <https://www.lfacapsulefillers.com/facf-range-plates-moulds-set>

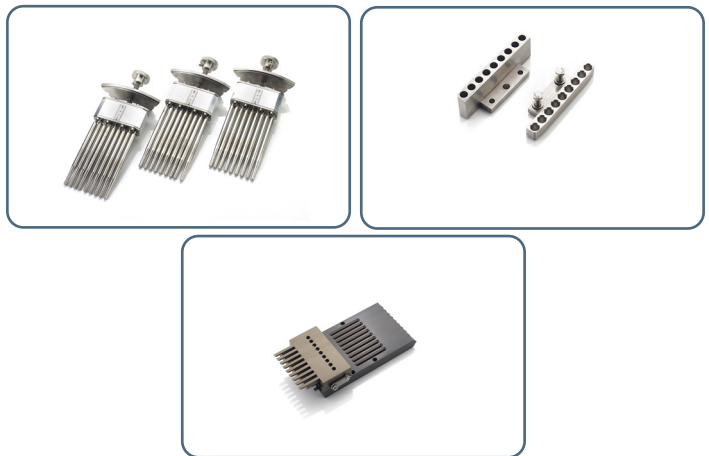

### Capsule Suction Distribution Manifold

The Capsule Section Distribution Manifold is located in the Vacuum Plate Assembly. Order at <https://www.lfacapsulefillers.com/capsule-suction-distribution-manifold-facf-range>

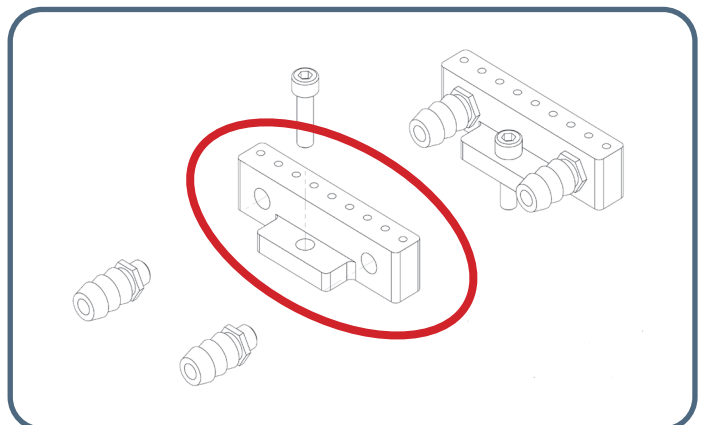

### **Dosing Plate**

The Dosing Plate is located in the Tamping Bowl and is part of the Dosing Panel Assembly. Order at <https://www.lfacapsulefillers.com/dosing-plate-fac-1200>

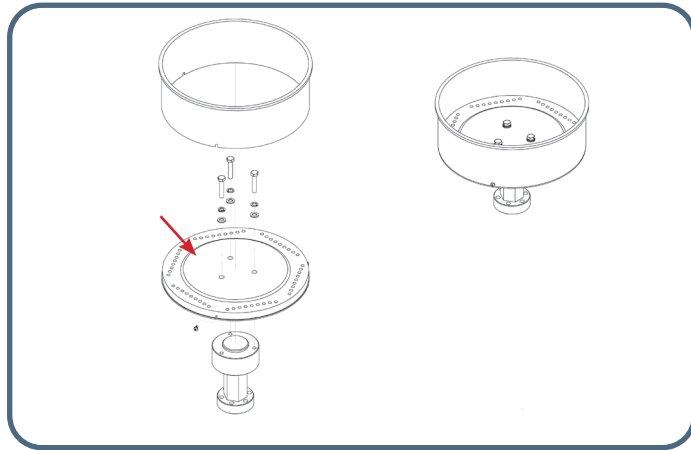

### **Dosing Disc Powder Loop**

The Dosing Disc Powder Loop sits on top of the Dosing Plate and is part of the Dosing Panel Assembly in the Tamping Station. Order at <https://www.lfacapsulefillers.com/dosing-disc-powder-loop-fac-1200>

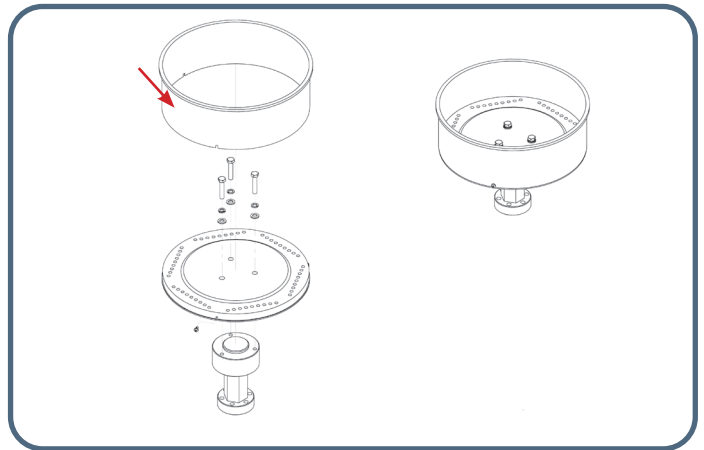

### **Capsule Filler Vacuum Pump**

The Capsule Filler Vacuum Pump works with the Capsule Sewing Section. Order at <https://www.lfacapsulefillers.com/capsule-filler-vacuum-pump>



## Food Grade Point of Contact Parts

Contact Part	Material
Tooling Plates and Molds	LY12 aluminum alloy and SUS304
Powder Hopper	SUS304
Capsule Hopper	SUS304
Alignment Tools	SUS304

## Technical Specifications

Product	FACF® 400	FACF® 1200	FACF® 2000	FACF® 3800
<b>Maximum Capsules per Minute</b>	400	1,200	2,000	3,800
<b>Capsule Size</b>	00 / 0 / 1 / 2 / 3 / 4 / 5	00 / 0 / 1 / 2 / 3 / 4 / 5	00 / 0 / 1 / 2 / 3 / 4 / 5	00 / 0 / 1 / 2 / 3 / 4 / 5
<b>Filling Precision</b>	±3%	±3%	±3%	±3%
<b>Filling Bores</b>	3	9	18	27
<b>Decibels (dB)</b>	≤78	≤78	≤78	≤78
<b>Weight (kg /lbs)</b>	600 kg / 1,322 lbs	900 kg / 1,984 lbs	1300 kg / 2,866 lbs	2400 kg / 5,291 lbs
<b>Power (kW)</b>	3.75	3.75	3.75	3.75
<b>Voltage (V)</b>	220/380	220/380	220/380	220/380
<b>Hertz (Hz)</b>	50	50	50	50
<b>3 Phase</b>	Yes	Yes	Yes	Yes
<b>Dimensions (mm / in)</b>	800 mm x 970 mm x 1870 mm 31.5 in x 38.1 in x 73.6 in	860 mm x 1020 mm x 1970 mm 33.8 in x 40.1 in x 77.5 in	1050 mm x 1200 mm x 2100 mm 41.3 in x 47.2 in x 82.6 in	1470 mm x 1850 mm x 2080 mm 57.87 in x 72.8 in x 81.88 in
<b>Floor Loading Limit (Static)</b>	4.56 kN/m <sup>2</sup>	7.74 kN/m <sup>2</sup>	16.06 kN/m <sup>2</sup>	64.02 kN/m <sup>2</sup>

# Maintenance Checklist

<b>Before Operation</b>	
<input type="checkbox"/>	Visually inspect the fully automatic capsule filler and the parts.
<input type="checkbox"/>	Ensure all nuts and bolts are tight.
<input type="checkbox"/>	Visually inspect grease points and regrease where necessary.
<input type="checkbox"/>	Run the machine at a slow speed to ensure that everything is operating correctly.
<input type="checkbox"/>	Visually inspect electrical wires for any damage.
<b>During Operation</b>	
<input type="checkbox"/>	Tune the fully automatic capsule filler until the capsule fill and weight are correct.
<input type="checkbox"/>	Listen for irregular knocking or clicking sounds. If heard, stop operation, dislodge any stuck capsules from the machine, adjust the Capsule Holding Pins, and lubricate the machine.
<input type="checkbox"/>	Watch for buildup of powder on the Auger inside the Powder Hopper. If occurring, either (a) make mix more granular, (b) check the Auger for damage, or (c) clear the buildup.
<input type="checkbox"/>	Occasionally check the Motor's temperature. If it starts to overheat, turn off the machine, let it cool down, and grease it to ensure smooth operation.
<input type="checkbox"/>	Ensure that the Hoppers do not run out of powder and capsules.
<input type="checkbox"/>	Weigh five or ten sample capsules to ensure the desired weight and fill are being met.
<input type="checkbox"/>	Check to see that the Emergency Stop properly works.
<b>After Operation</b>	
<input type="checkbox"/>	Unplug machine and remove all excess powder with a bagless vacuum.
<input type="checkbox"/>	Clean the Capsule Hopper, the Powder Hopper, the Capsule Magazine and teeth, the Tooling, and the Auger.
<input type="checkbox"/>	Wipe down the other surfaces with a damp cloth.
<input type="checkbox"/>	Lubricate all grease points.
<input type="checkbox"/>	Store Tooling in a container with a small amount of grease.



# Diagrams

## FACF 1200® Floor Plan

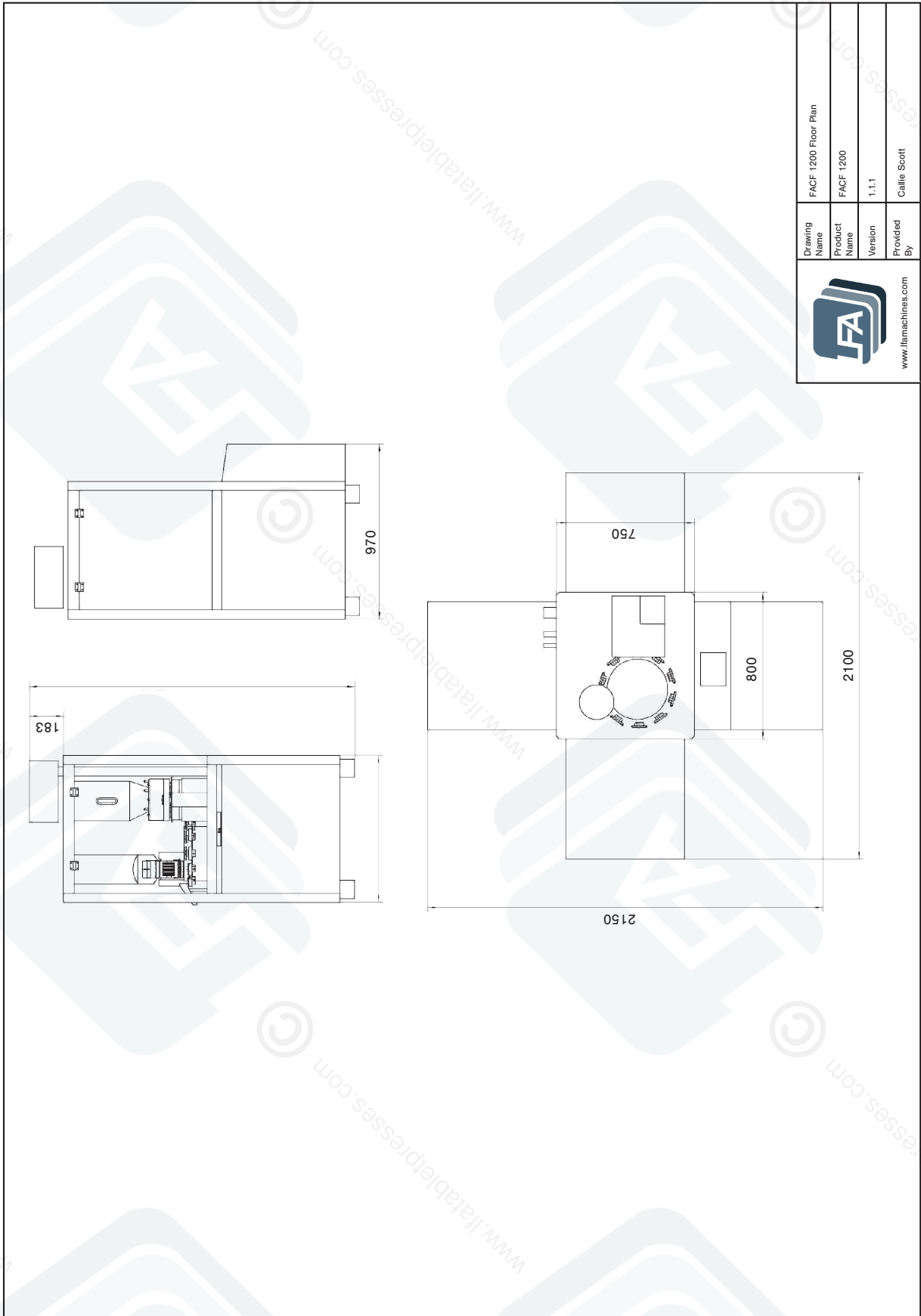

 www.jfamachines.com	Drawing Name	FACF 1200 Floor Plan
	Product Name	FACF 1200
	Version	1.1.1
	Provided By	Callie Scott

# FACF 1200® Wiring Diagram 1

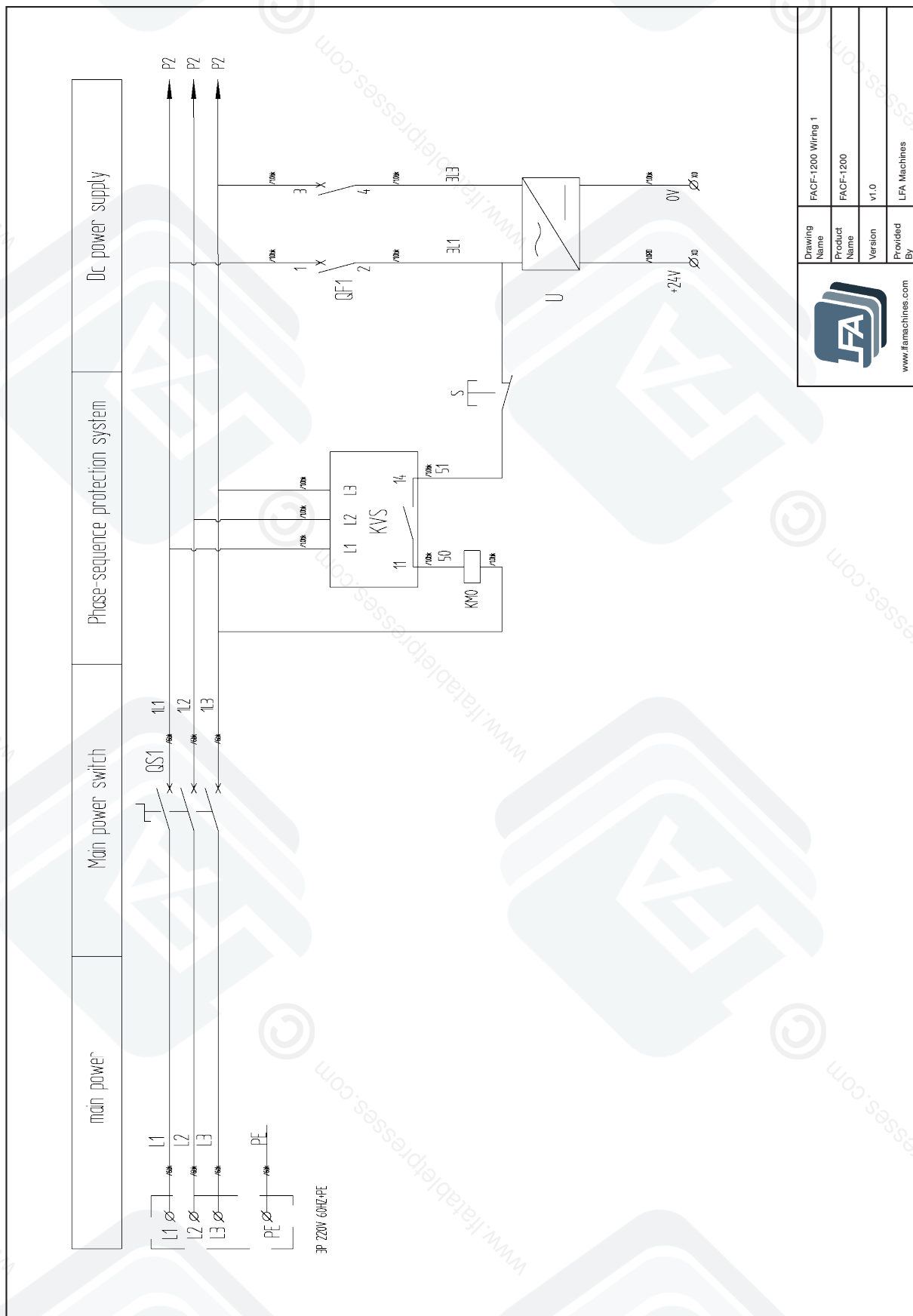

 www.lfamachines.com	Drawing Name	FACF-1200 Wiring 1
	Product Name	FACF-1200
	Version	v1.0
	Provided By	LFA Machines

# FACF 1200® Wiring Diagram 2

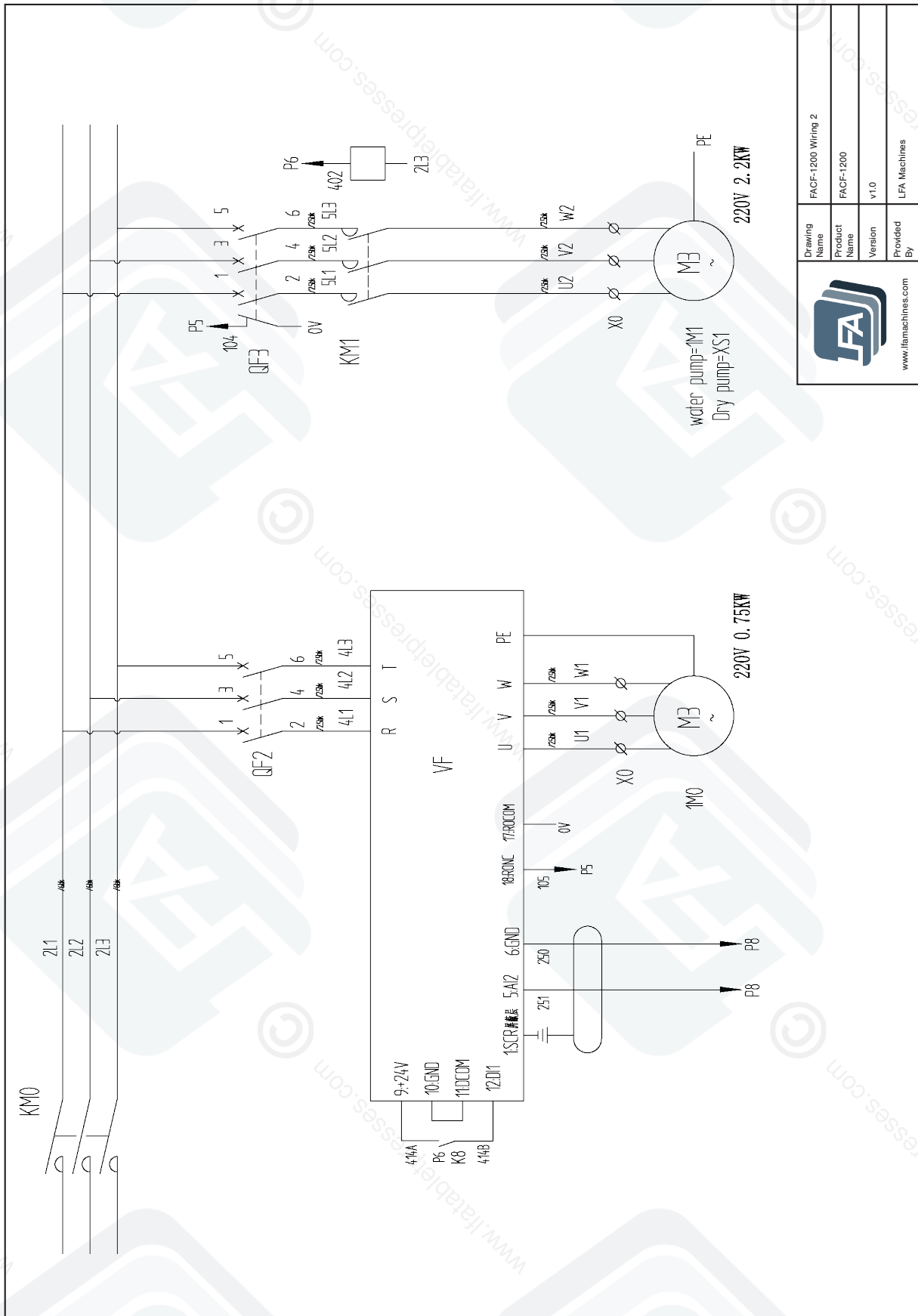

 www.lfamachines.com	Drawing Name	FACF-1200 Wiring 2
	Product Name	FACF-1200
	Version	v1.0
	Provided By	LFA Machines

# FACF 1200® Wiring Diagram 3

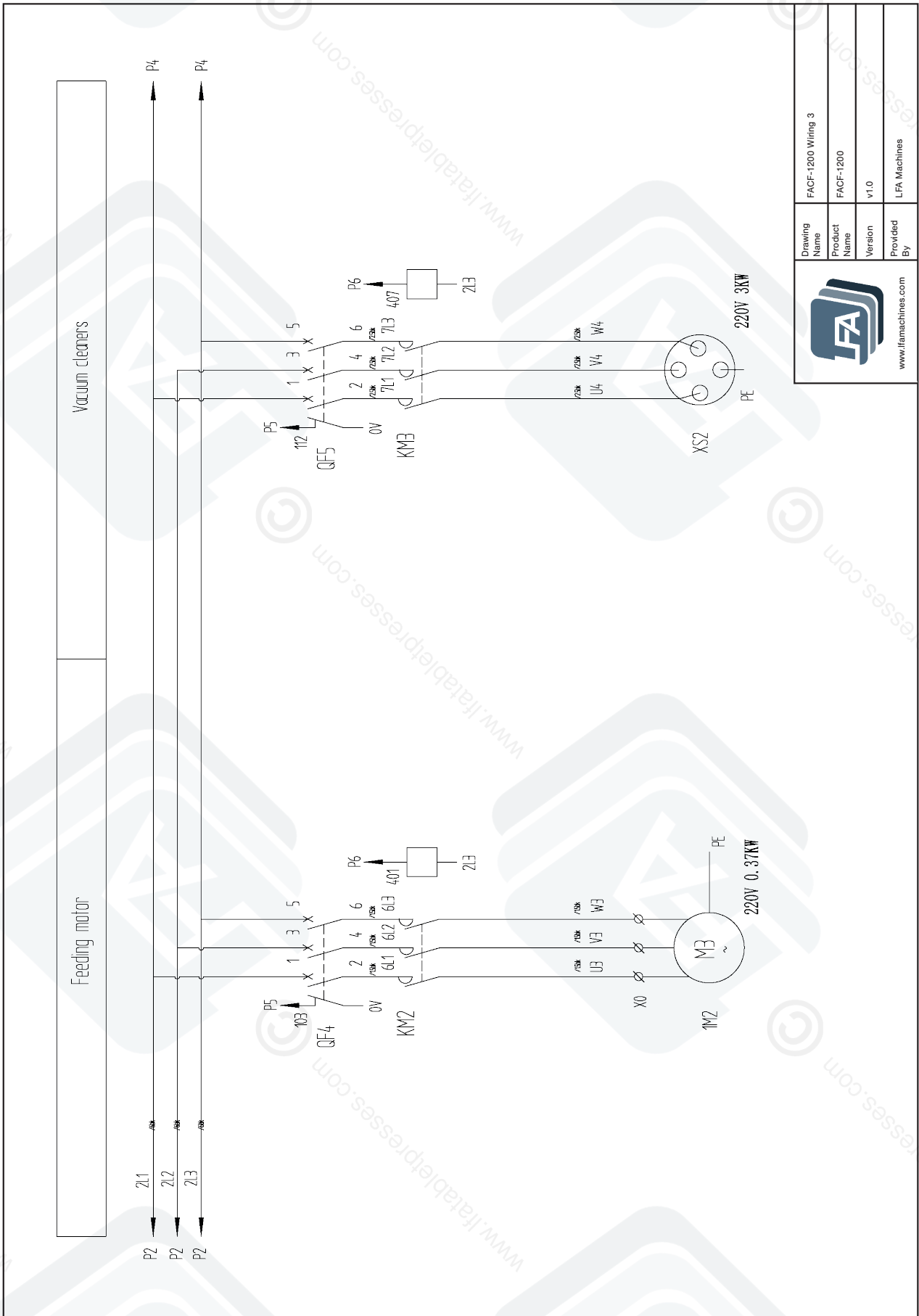

Drawing Name	FACF-1200 Wiring 3
Product Name	FACF-1200
Version	v1.0
Provided By	LFA Machines



www.lfamachines.com

# FACF 1200® Wiring Diagram 4

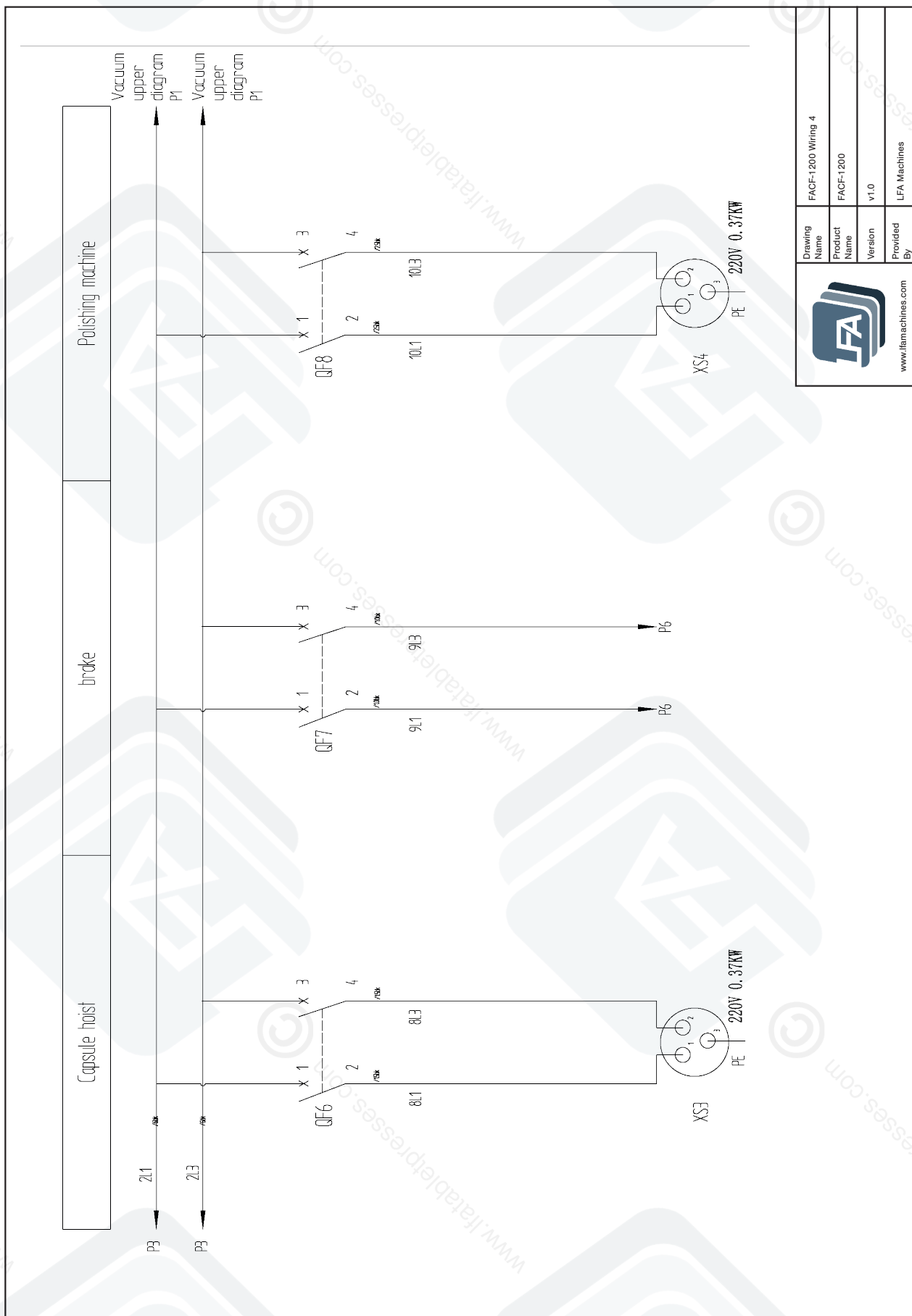

Drawing Name	FACF-1200 Wiring 4
Product Name	FACF-1200
Version	v1.0
Provided By	LFA Machines



www.lfamachines.com







# FACF 1200® Wiring Diagram 7

 www.lfamachines.com	Drawing Name	FACF-1200 Wiring 7
	Product Name	FACF-1200
	Version	v1.0
	Provided By	LFA Machines

PLC  
Power supply

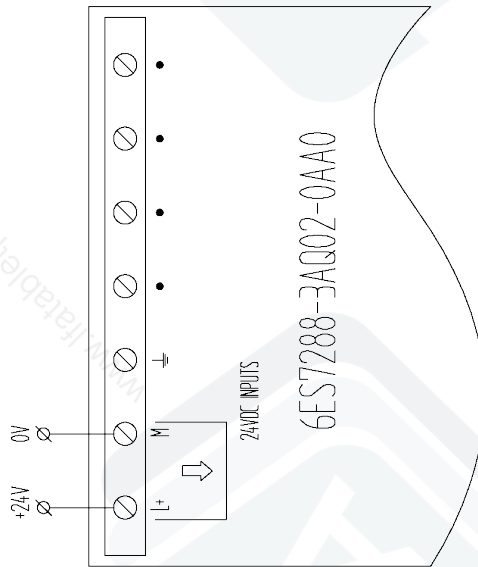



# FACF 1200® Wiring Diagram 9

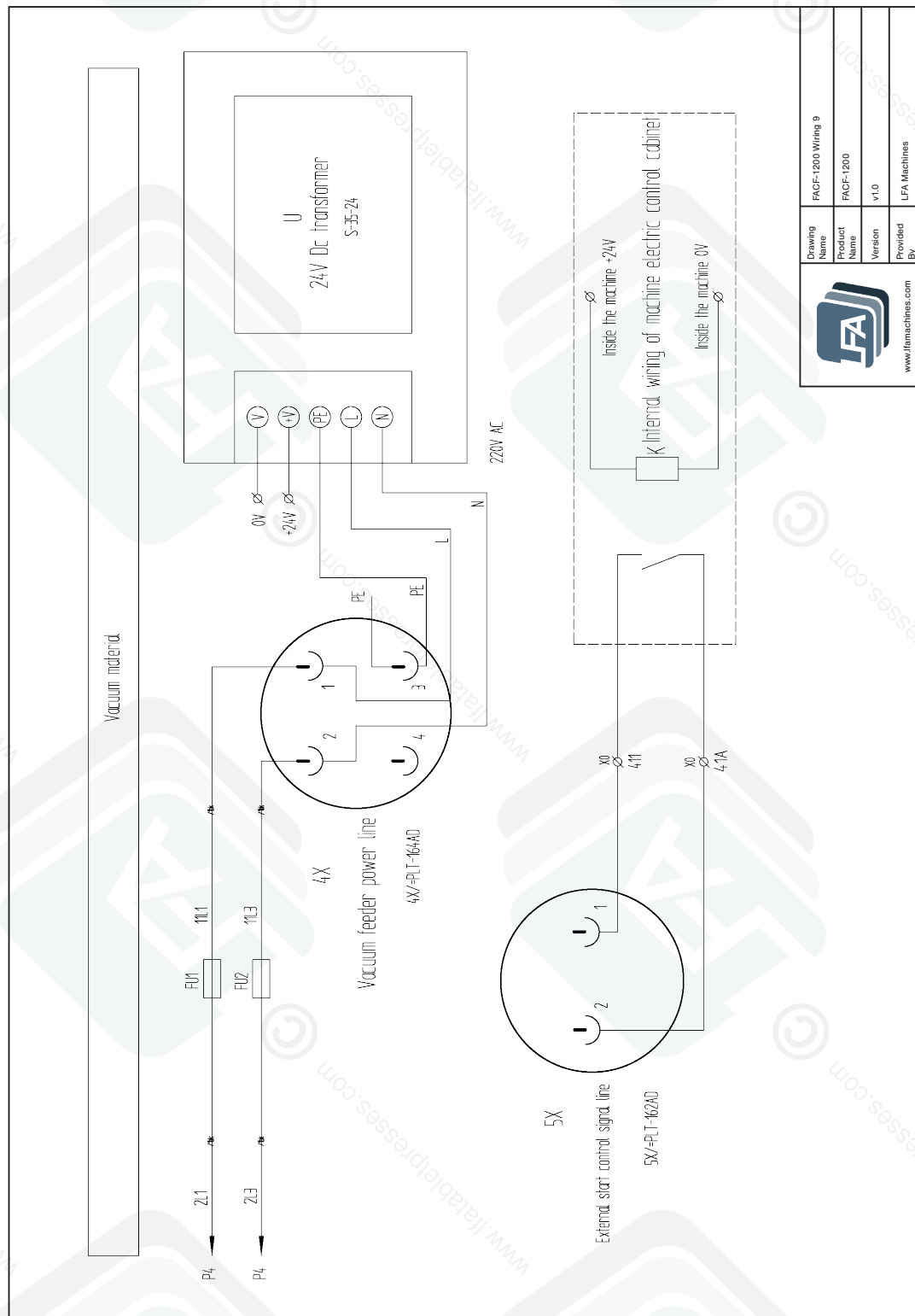

 www.lfa.com	Drawing Name	FACF-1200 Wiring 9
	Product Name	FACF-1200
	Version	v1.0
	Provided By	LFA Machines



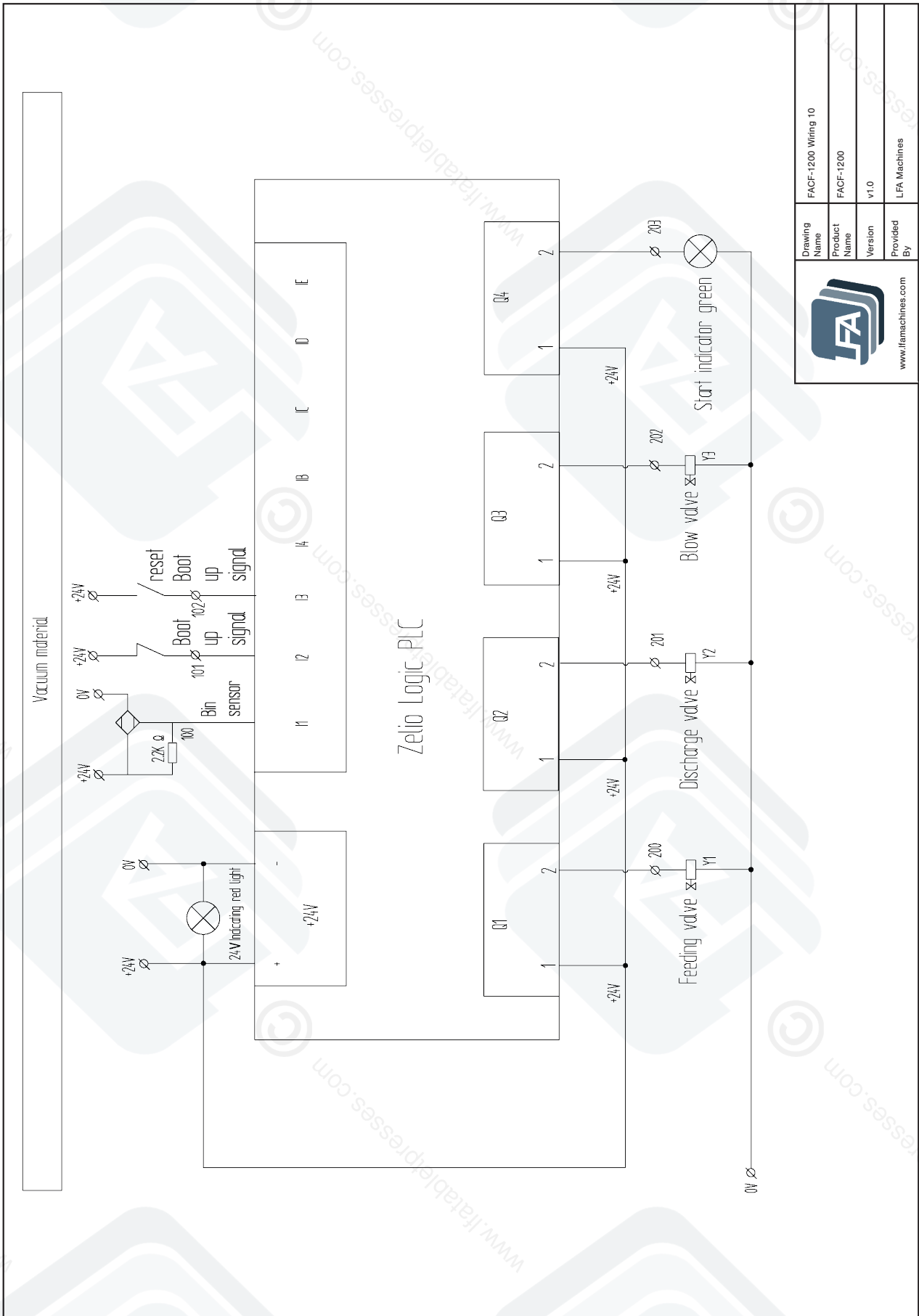

# FACF 1200® Wiring Diagram 10

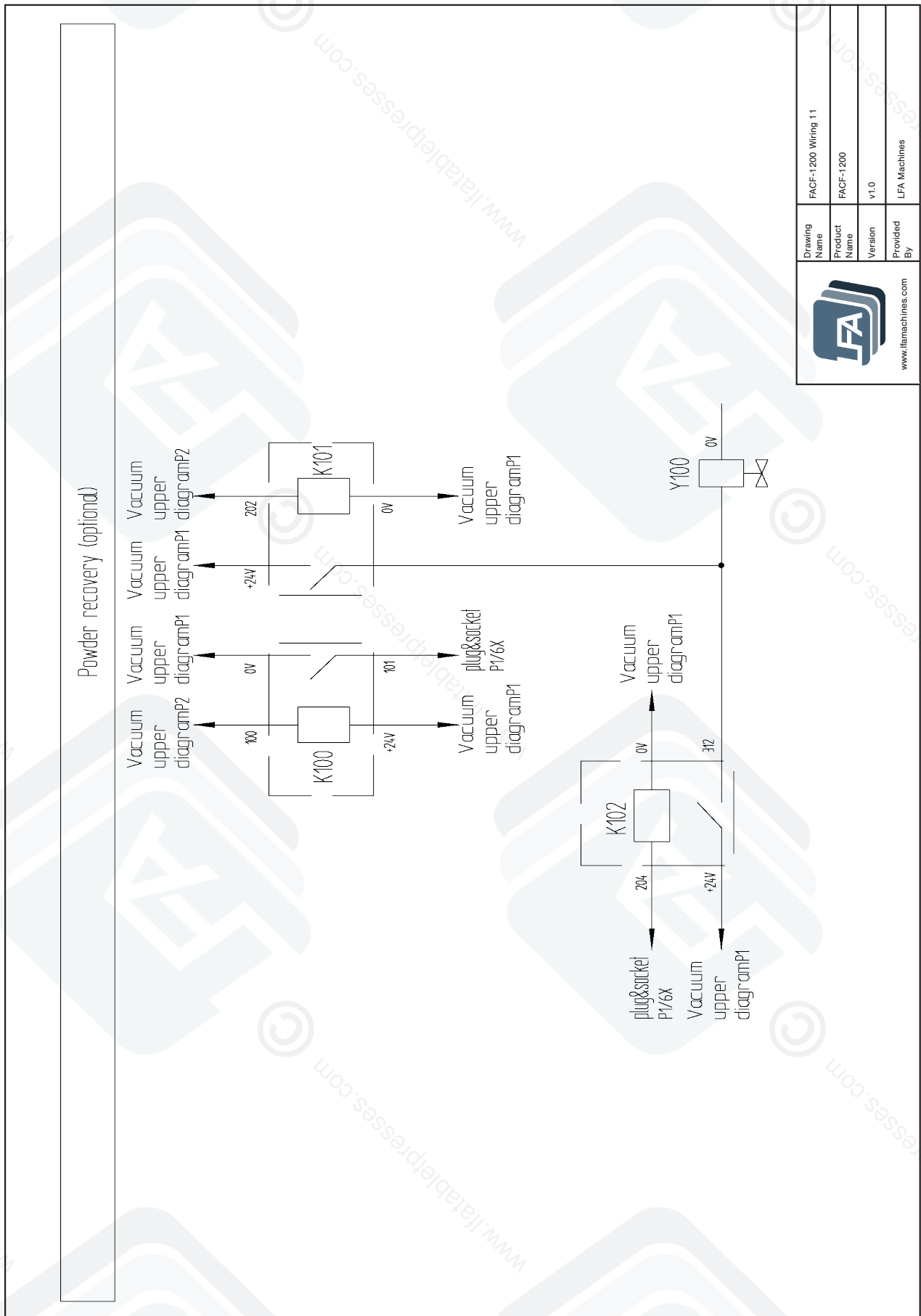

 www.lfamachines.com	<b>Drawing Name</b> FACF-1200 Wiring 10
	<b>Product Name</b> FACF-1200
	<b>Version</b> v1.0
	<b>Provided By</b> LFA Machines

# FACF 1200® Wiring Diagram 11



 www.lfamachines.com	Drawing Name	FACF-1200 Wiring 11
	Product Name	FACF-1200
	Version	V1.0
	Provided By	LFA Machines

# FACF 1200® Wiring Diagram 12

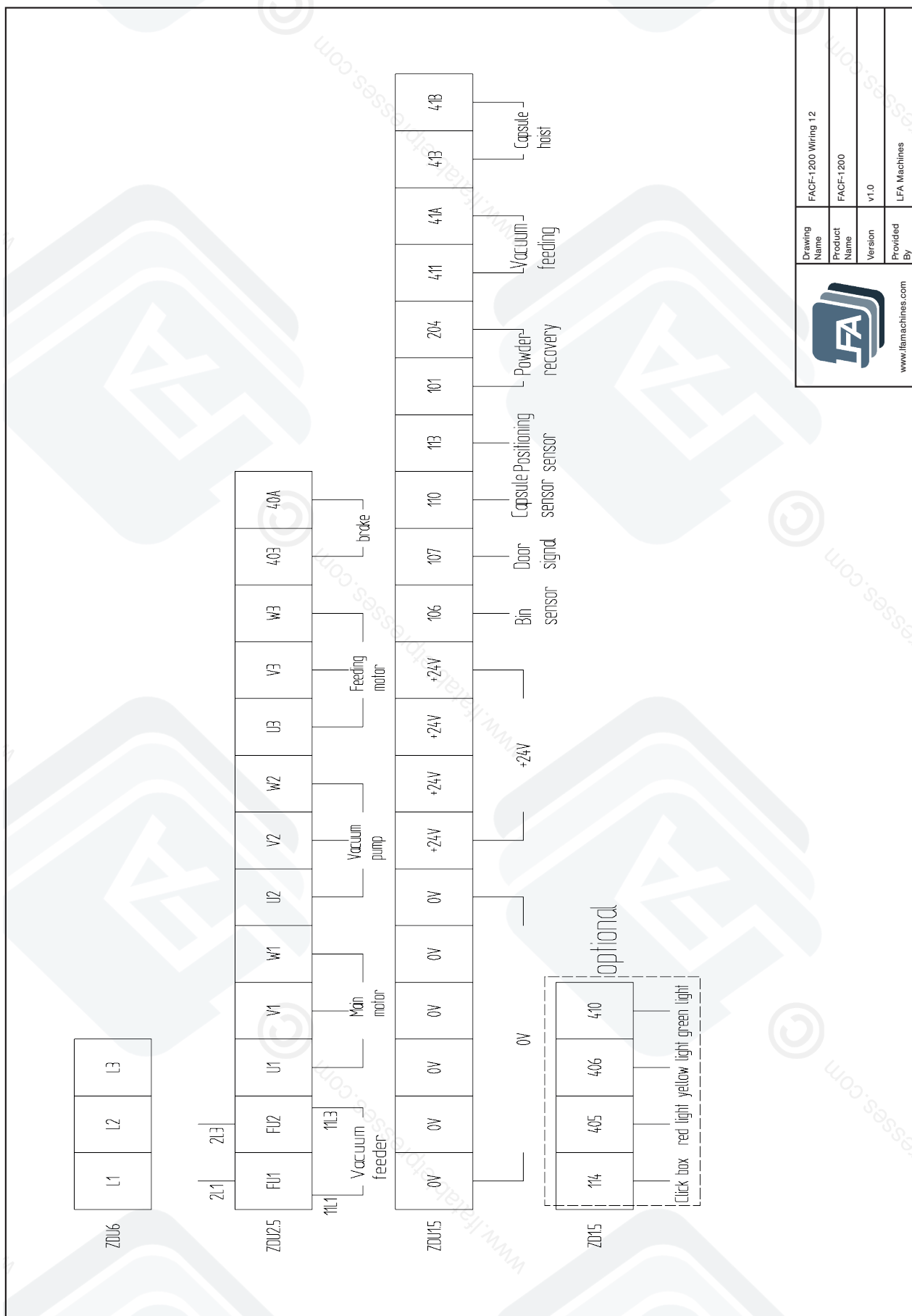

 www.lfamachines.com	Drawing Name	FACF-1200 Wiring 12
	Product Name	FACF-1200
	Version	v1.0
	Provided By	LFA Machines

# FACF 1200® Wiring Diagram 13

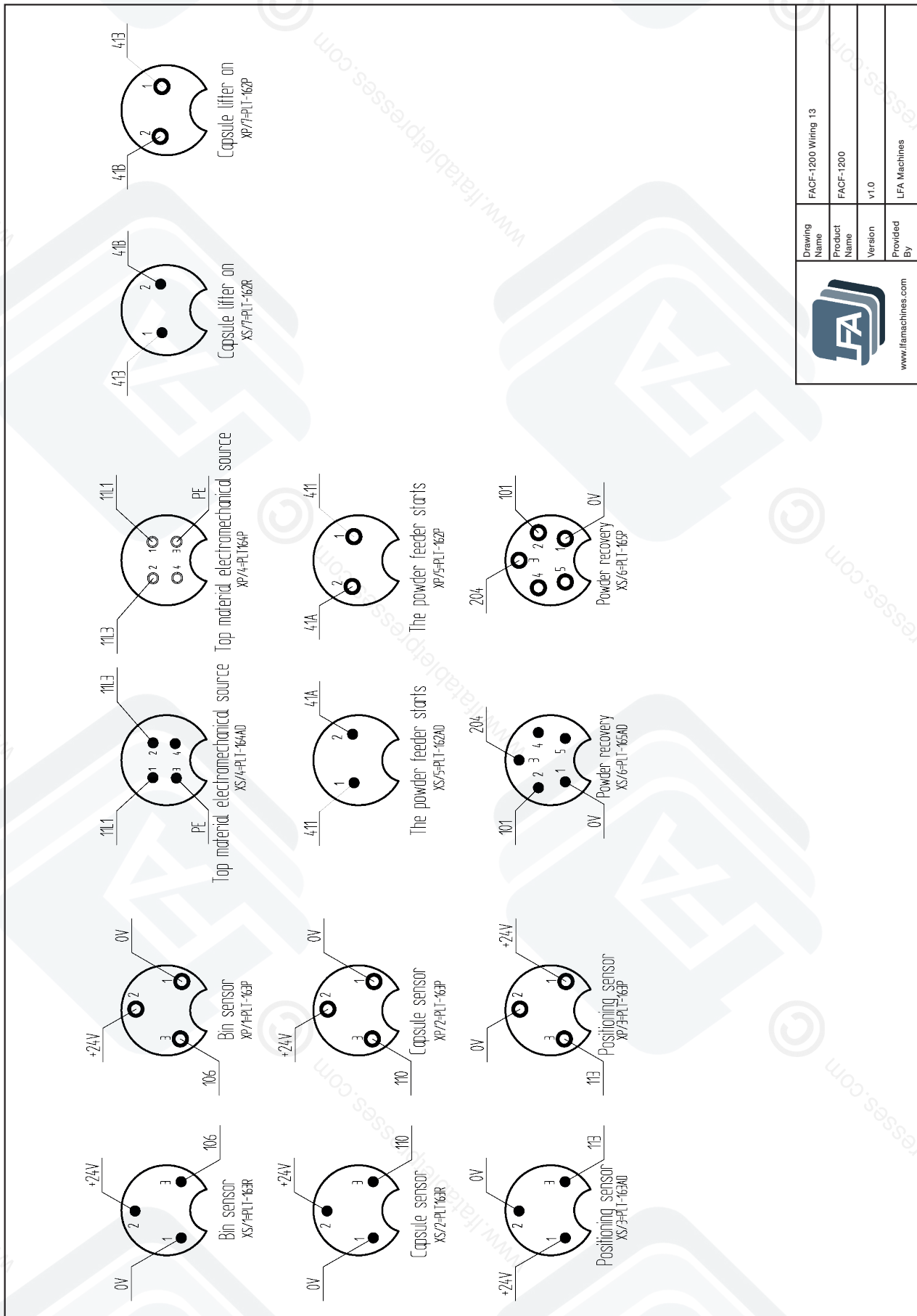

 www.lfamachines.com	Drawing Name	FACF-1200 Wiring 13
	Product Name	FACF-1200
	Version	v1.0
	Provided By	LFA Machines

# FACF 1200® Wiring Diagram 14

## Components list

No.	Symbol	Description	Model	No.	Symbol	Description	Model	No.	Symbol	Description	Model
1	CPUS140	PLC	6ES7288-1400-0AA0	14	KM1	contactor	3RT16026-1AN20				
2	VF	VFD	ACS355-0AE-07A5-2	15	KM2	contactor	3RT16016-1AN21				
3	HMI	Siemens touch screen	6AV6648-0CC11-3AX0	16	KM3	contactor	3RT16026-1AN20				
4	QS1	Power switch	PI-32	17	U	Dr. power supply	LFS-50-24				
5	QF1	air switch	5SL62047CC	18	KVS	Phase sequence protector	3UG4512-1AR20				
6	QF2	air switch	5SL63167CC	19	K	weidmueller relay	PR474024ID/SI02CECO				
7	QF3	switch	3RV6011-1KA10	20	X0	weidmueller terminal	ZDU15/ZDU25/ZDU16				
8	QF4	switch	3RV6011-1CA10	21	H1	buzzer	HRB-PS30-DC24V				
9	QF5	switch	3RV6011-1KA10	22	XS1	Dry pump socket	5623				
10	QF6	air switch	5SL62167CC	23	XS2	Vacuum socket	5618				
11	QF7	air switch	5SL62047CC	24	XS3	Capsule host source	5601				
12	QF8	air switch	5SL62167CC	25	XS4	Polished electromechanical source	5601				
13	KM0	contactor	3RT16027-1AN20								

 www.lfamachines.com	Drawing Name	FACF-1200 Wiring 14
	Product Name	FACF-1200
	Version	v1.0
	Provided By	LFA Machines



### VFD parameters setting

9904	Vector speed
9905	Motor rated voltage
9906	Motor rated current
9907	Motor rated frequency
9908	Motor speed rating
9909	Motor rating
1001	D11 (Start the way)
1003	Positive rotation
1103	A12 (Select the external given signal source)
2101	automatic2 (Start the way)
2102	Free parking
2202	5 (To speed up the time)
2203	2 (Deceleration time)
1105	2000 (Maximum speed setting value)
2002	2000 (The highest speed)

 www.lfamachines.com	Drawing Name	FACF-1200 Wiring 16
	Product Name	FACF-1200
	Version	v1.0
	Provided By	LFA Machines

# Resources

## Helpful Links

### Warranty

For information regarding the warranty policy of the FACF® range and other LFA products, please visit <https://www.lfacapsulefillers.com/warranty>

### LFA Website

In order to aid you in your capsule production, LFA Machines maintains a website that offers a breadth of useful information about the FACF® range and other capsule fillers. You also have access to online tools such as the Capsule Size Chart and our regularly published articles that cover a whole range of topics about capsule fillers and capsule production.

Visit the LFA homepage at <https://www.lfacapsulefillers.com>

To create a free member's account, follow this link: <https://www.lfacapsulefillers.com/customer/account/create>

### LFA Machines YouTube Channel

Our YouTube videos provide you an opportunity to see demonstrations of how to use our fully automatic capsule fillers, common troubleshooting tips, and other LFA capsule fillers and mixers. We regularly upload videos to give you a visual aid that will hopefully support you in your capsule production efforts. To watch our videos, visit <https://www.youtube.com/channel/UCwtbcwja77ai7vX2o34FUkQ>

### LFA Machines Social Media

Social media is a great way to keep yourself updated on new developments and exciting things happening at LFA Machines. The list below contains our current social media pages:

Twitter: @lfatabletpress

Instagram: @lfatabletpresses

Facebook: <https://www.facebook.com/lfatabletpresses>

LinkedIn: <https://www.linkedin.com/company/lfamachines-oxford-ltd/>

## Contact Us

### UK

LFA Machines Oxford Ltd  
Unit 4B Rowood Estate  
Murdock Road  
Bicester, Oxfordshire OX26 4PP  
+44 (0) 1869 250 234  
[sales@lfamachines.com](mailto:sales@lfamachines.com)  
Monday-Friday  
9AM-5PM GMT

### US

LFA Machines DFW, LLC  
955 N. Sylvania Ave  
Fort Worth, TX 76111  
English: +1 (682) 312 0034  
Spanish: +1 (682) 312 0309  
[sales.usa@lfamachines.com](mailto:sales.usa@lfamachines.com)  
Monday-Friday  
8:30AM-4:30PM UTC (Central)

### Germany

LFA Machines Düsseldorf GmbH  
Business Parc Am Trippelsberg 92  
Düsseldorf, North-Rhine  
Westphalia 40589  
+41 21188250223  
[verkauf@lfamachines.com](mailto:verkauf@lfamachines.com)

### Taiwan

LFA Machines Taiwan Ltd  
7F-5, No. 2, Sec. 2 Taiwan Blvd  
West District, Taichung City 403  
Taiwan  
+886 2773 74704  
[sales.asia@lfamachines.com](mailto:sales.asia@lfamachines.com)



LFA MACHINES

Copyright © 2020 by LFA Machines

[www.lfamachines.com](http://www.lfamachines.com)

**United Kingdom**

Unit 4B  
Murdock Road  
Bicester  
Oxfordshire  
United Kingdom

**United States**

955 N Sylvania Ave  
Fort Worth  
Texas  
United States

**Germany**

Business Parc Am  
Trippelsberg 92  
Düsseldorf  
Germany

**Taiwan**

403, Section 2, 2  
Taiwan Boulevard  
Taichung City  
Taiwan