



FACF 1200[®]

Fully Automatic Capsule Filler

User Manual



We don't just sell machines—
we provide service.

Copyright Notice

© LFA Machines Oxford Limited, published in 2026 by LFA Machines Oxford Limited 2025. Registered in England and Wales, company number 08428898, registered office for service Demar House 14 Church Road East Wittering, Chichester, West Sussex, PO20 8PS.

All rights reserved. No part of this publication may be reproduced or transmitted, in any form or by any means, or stored in any retrieval system of any nature, without prior permission, except for fair dealing under the Copyright, Designs and Patents Act 1988, or in accordance with the terms of license issued by the Copyright Licensing Agency in respect of photocopying and/or reprographic reproduction. Application for permission for other use of the copyright material including permission to reproduce extracts in other published works shall be made to the publisher. Full acknowledgment of author, publisher and source must be given.

All trade marks are acknowledged and are owned by their respective owners.

Important Safety Information

READ THIS BEFORE OPERATING MACHINE

Intended Use

The intended use of this machine is to fill empty capsules with dry raw materials.

Potential misuse of this machine includes:

- Using any capsules that deviate from the standard two-piece design.
- Using softgel capsules.
- Using powders that could explode under pressure.
- Using wet or damp material.

Personal Protection

For personal protection while transporting the FACF® range, abide by these actions:

- Use a pallet jack to lift the machine.
- Wear steel toe boots to prevent foot injury.
- Wear heavy duty grip gloves to ensure firm grasp on machine.
- Wear back support belt to prevent injury if needed.

For personal protection while operating the FACF® range, abide by these actions:

- Avoid wearing loose jewelry to prevent machine entanglement.
- Contain long hair to prevent machine entanglement.
- Wear safety goggles.
- Wear disposable latex/rubber gloves.
- Wear a hairnet (food grade products only).
- Wear a beard net if needed (food grade products only).

General Hazards

In the case of an emergency during operation, immediately push the Emergency Stop button.

- Do not allow powder to collect at the Turret and Tamping Station.
- Be aware of risk of entanglement and pinch point due to moving parts.
- Do not operate in a wet environment or with wet hands due to risk of electrical shock or burn.
- Do not operate if any wires are exposed in cables due to risk of electrical shock or burn.
- Use extreme caution when servicing any electrical component.
- Keep out of reach from children.
- Keep fingers away from all moving parts.
- Inspect machine before use.
- Check that nuts and bolts are suitably tightened.
- Use this machine only for its intended use as described in this manual.
- Do not modify the machine in any way.
- Turn off and unplug the machine before conducting cleaning and maintenance.

Safety Assessment

It is critical to conduct a safety assessment to ensure that it complies with all local laws and industry accepted safety regulations.

If you require guidance on the installation of the machine or conducting a safety assessment, please contact LFA Machines.

Important Safety Information

READ THIS BEFORE OPERATING MACHINE

Symbols



WARNING

This signals potential risk for personal injury.



WARNING

This signals potential risk for electrical shock.



CAUTION

This signals potential risk for damage to the machine or other parts.

Modes for Stopping

In the case of an emergency during operation, immediately push the Emergency Stop button or isolator switch on the righthand side and unplug the FACF® range:



Prop. 65 Statement for CA Residents

Based on LFA's current level of knowledge of our machines, the FACF® range does not require a Proposition 65 warning label.

Warning for Explosive Material

This machine is not explosion proof. Ensure that your machine is grounded. LFA recommends that you test your materials' explosivity before running them through this machine. If your materials are indeed explosive, do not use them with this machine. To look up ingredients and their explosivity, go to <https://staubex.ifa.dguv.de/?lang=e>

Table of Contents

Copyright Notice	2
Important Safety Information	3
Intended Use	3
Personal Protection	3
General Hazards	3
Safety Assessment	3
Symbols	4
Modes for Stopping	4
Prop. 65 Statement for CA Residents	4
Warning for Explosive Material	4
FACF® Range Components	6
Preface	7
Training	8
How Much Training is Required to Operate the FACF®?	8
Off-Site Training	8
Training via Video Chat/Phone	8
LFA Articles	8
LFA Videos	8
Installation	9
Tools and Materials Needed	9
Positioning the FACF® Range	12
Controls	14
Settings and Adjustment	18
Maintenance	45
General Maintenance Prescriptions	45
Lubrication	45
Dismantling for Repair and Replacement	48
Wear Parts and Causes of Damage	49
Troubleshooting	92
Common Issues	92
Common Issues Continued	93
Common Issues Continued	94
De-Jamming the FACF® Range	95
Cleaning	97
Storing the FACF® Range	100
Appendix	101
Glossary	101
Description of FACF® Range Parts	102
Food Grade Point of Contact Parts	104
Technical Specifications	104
Capsule Production Rates	105
Dust Collector Specifications	105
Vacuum Pump Specifications	106
Toolbox Contents	107
Maintenance Checklist	112
Diagrams	113
Resources	129

FACF® Range Components

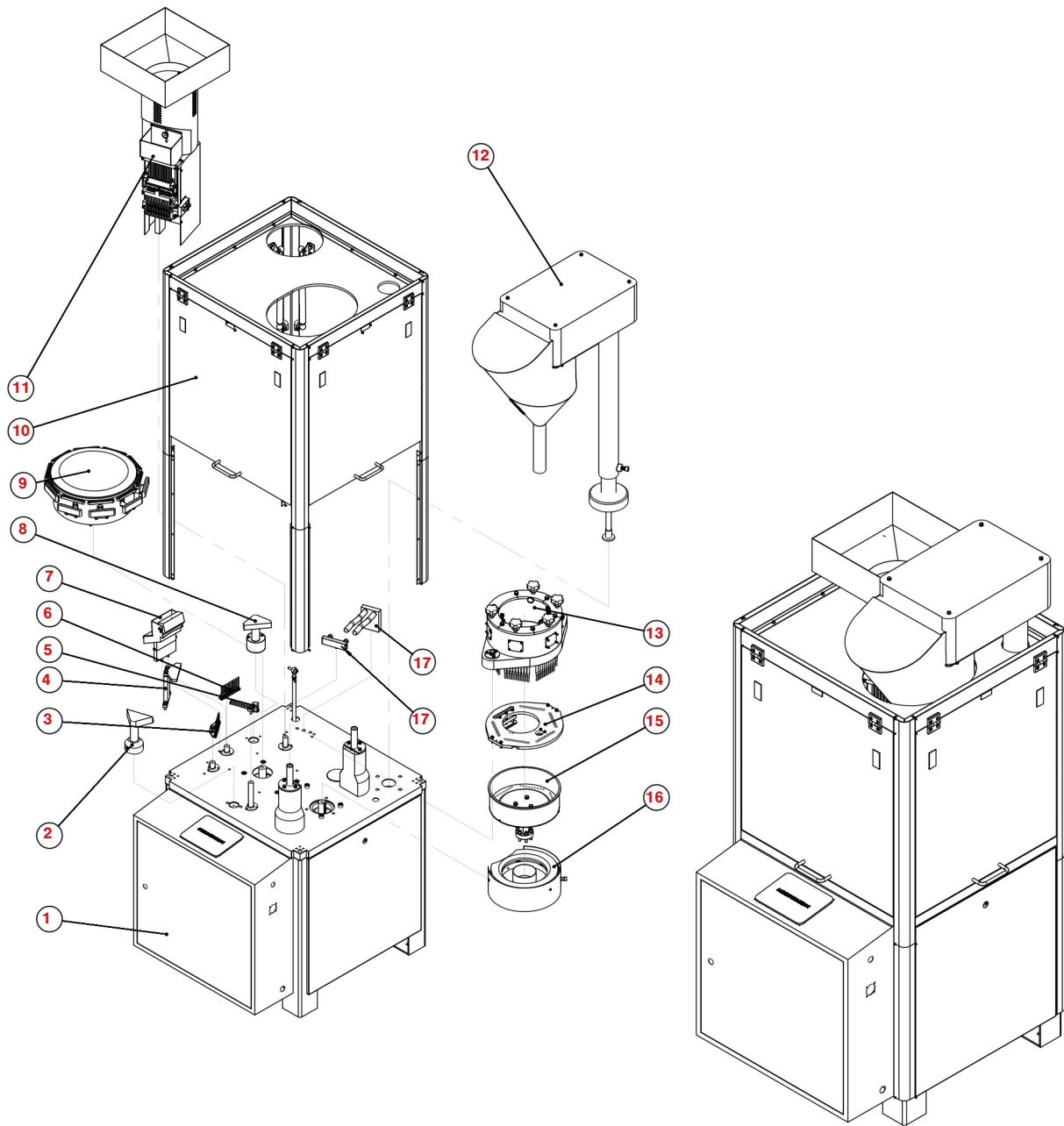

- 1. Electrical Cabinet
- 2. Vacuum Rejection Assembly
- 3. Capsule Sealing Pins Assembly
- 4. Capsule Sealing Plate Assembly
- 5. Unseparated Capsule Ejection
- 6. Capsule Ejections Pins
- 7. Capsule Ejection Chute
- 8. Vacuum Cleaning Assembly
- 9. Die Segment Turret
- 10. Outer Casing

- 11. Capsule Sewing Assembly
- 12. Powder Auger Assembly
- 13. Dosing Station Tamping Pins Assembly
- 14. Tamping Pins Guide Runner
- 15. Tamping Bowl/Dosing Disk
- 16. Dosing Station Lower Assembly
- 17. Vacuum Manifold and Vacuum Plate Composition

Preface

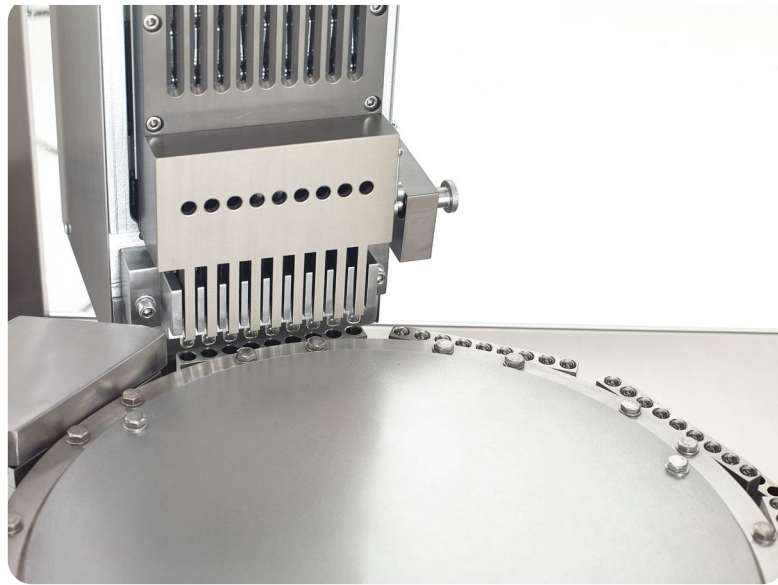

The FACF[®] range is a set of fully automatic capsule fillers that accurately and efficiently produce capsules of varying sizes per minute. By using intermittent motion and stations for dosing and tamping, the FACF[®] range provides precise capsule orientation and dosing with a high filling rate. The FACF[®] range has been designed for exceptional output and efficiency while keeping batch profitability as high as possible with minimal downtime. The table below shows the capabilities of each machine in the FACF[®] range:

Product	FACF 400 [®]	FACF 1200 [®]	FACF 2000 [®]	FACF 3800 [®]
Maximum Capsules per Minute	400	1,200	2,000	3,800
Capsule Size	00 / 0 / 1 / 2 / 3 / 4 / 5	00 / 0 / 1 / 2 / 3 / 4 / 5	00 / 0 / 1 / 2 / 3 / 4 / 5	00 / 0 / 1 / 2 / 3 / 4 / 5
Filling Precision	±3%	±3%	±3%	±3%
Filling Bores	3	9	18	27

The purpose of this document is to support your understanding of the FACF[®] range's components, features, functions, and design. With this manual, you will be able to successfully operate and maintain your FACF[®] range machine.

The user manual's content includes:

- Important safety information
- FACF[®] range installation instructions
- Description of the FACF[®] range's operation
- FACF[®] range maintenance information
- Appendix with supplemental information

Training

FACF® range training is essential for the machine's successful operation and your personal safety. There are several methods to prepare you for working with the FACF® range.

How Much Training is Required to Operate the FACF®?

We do require at least 2 days of training from one of our technicians. These 2 days with our technician will specifically be for training purposes, but if you need installation help, please let us know. Before shipping the machine to your facilities, our sales team will set up a time to have our technician meet you and the machine at your location. Our technician will spend 2 days with you and your team. During this time they will set up and install the machine and then walk you and your team through the ins-and-outs of the machine. At the end of the 2 day training, if you feel you need more time with our technician we would be happy to extend the time for you.

Off-Site Training

LFA also offers training at our UK, USA, and Taiwan facilities for all our customers and their teams. For more information, go to <https://www.lfacapsulefillers.com/services>

Training via Video Chat/Phone

Using an online video chat system, an LFA technician can interact face-to-face with you and assist with your understanding of the machine. Or, if you prefer, LFA can provide training via phone for all customers who call the office. To set up a training, call or email your local LFA office:

UK

Phone

+44 01869 250234

Email

support.uk@lfamachines.com

USA

Phone

+1 (682) 312-0034

Email

support.usa@lfamachines.com

Taiwan

Phone

+886 422031790

Email

support.asia@lfamachines.com

LFA Articles

LFA writes informative articles about capsules and capsule fillers, which includes instructions, procedures, and guides. To access the articles, go to <https://www.lfacapsulefillers.com/articles>

LFA Videos

LFA has created several videos involving the FACF® range and other capsule fillers. To access the videos, go to <https://www.lfacapsulefillers.com/videos> or <https://www.youtube.com/user/TabletPillPress>

Installation

Tools and Materials Needed

Before you install and operate the FACF® range, it is best to have the following tools and materials on hand for general operation and maintenance:

- Forklift
- Pallet jack
- Crowbar
- Hammer
- 2 carts for cleaning machine and break down (e.g. [Uline carts](#))
- Toothbrush
- Cleaner (e.g. Member's Mark Commercial Lemon Disinfectant)
- Sanitizer (e.g. Member's Mark Commercial Sanitizer)
- Lubricant (NSF approved type for food grade products)
- In-line ionizer to reduce static charge (e.g. [Fraser](#))
- Permanent marker
- Cleaning brush/paintbrush
- Plastic sheet or something similar to cover machine
- Safety goggles
- Hairnet and/or beard net (food grade products only)
- Sterile shoe covers (food grade products only)

The Appropriate Workstation for the Machine

The floor on which the machine is to be placed must support the FACF® range's 850 kg-1850 kg (about 1,874 lbs-4,078 lbs) weight. The table below shows the static floor loading limit for each machine in the FACF® range:

Machine	Static Floor Loading Limit
FACF 400®	15.12 kN/m ²
FACF 1200®	15.12 kN/m ²
FACF 2000®	42.67 kN/m ²
FACF 3800®	41.35 kN/m ²

The machine's motor requires a three-phase power supply of 220 V (USA) or 440 V (UK). Ensure to position the machine near an appropriate electrical plug.

Environmental Conditions

It is important that the environment in which you operate and store the FACF® machine has the appropriate temperature and relative humidity levels. These two environmental factors can potentially cause the machine to rust and/or cause the capsules to have a lower quality. The table below shows the acceptable temperature and relative humidity levels:

Machine	Temperature		Humidity
	°C	°F	
FACF®	18-24	64-75	45-55% RH

The shipping crates will contain the following:

1. The FACF®



2. The Tooling (already installed)



3. Anti-vibration feet

4. Vacuum Pump and Filter

5. Toolbox (refer to contents list in Appendix for more information)

6. Dust collector

Unpacking the FACF® Range

Tools Needed

- Crowbar
- Hammer
- Socket wrench set
- Forklift (lift 5000 lbs minimum)

Instructions

1. Pry open each side of the shipping container with a crowbar and hammer and remove them.
2. Remove the Filter, Vacuum Pump, Toolkit, and Power Cable.
 - 2.1 Note: Be careful not to drop the heavy Vacuum Pump.
3. Remove the bolts on the shipping container's base with a socket wrench.
 - 3.1 Note: Keep the nuts, bolts, and the shipping container's base in case you need to move or relocate the machine.
4. Place the forklift underneath the machine and lift it.
 - 4.1 Note: Lift the machine high enough to insert the anti-vibration feet.
5. Attach the anti-vibration feet to each bottom corner of the machine.
6. Carefully lower the machine to the ground.

Positioning the FACF[®] Range



WARNING: To prevent personal injury, wear steel toe boots and heavy duty grip gloves while transporting the FACF[®] range.

Because of its weight, LFA does NOT recommend carrying the machine manually but rather with a forklift. At least two people should be involved (one operating the forklift and one stabilizing the machine) in removing the machine from the shipping container and placing it in the workspace.

Moving the FACF[®] with a Forklift

Tools Needed

- Pallet jack
- Heavy duty grip gloves
- Steel toe boots

Instructions

1. Raise the machine from the ground with a pallet jack.
2. Carefully guide the machine to the desired location.
 - 2.1 Note: The machine's motor requires a three-phase power supply of 220 V or 440 V. Ensure to position the machine near an appropriate electrical plug.
3. Carefully lower the pallet jack until the anti-vibration feet make contact with the floor.
4. Place the Filter on top of the Vacuum Pump.
 - 4.1 Note: Use plumber's tape around the threaded part of the Vacuum Pump to ensure a good seal to reduce pressure loss.
5. Plug in the Vacuum Compressor and main power cable.
6. Plug in the Vacuum Pump's hose and tighten it with a flathead screwdriver.
7. Insert the 8 mm/12 mm push fit airline.





WARNING: To prevent against personal and machine injury, ensure that the machine is grounded before operating.

Be sure that the machine machine's frame is connected to ground by running a cable back to the socket or by attaching the machine to a grounding bar.

This will protect the machine from electrical shock, explosions, and the build up of static, which causes capsules to stick together.

Controls

Basic Components



A description of the principal components follows:

- The **Capsule Hopper** holds the empty capsules.
- The **Capsule Sewing Station** aligns the capsules in the correct position with a magazine and inserts them into the capsule die segments.
- The **Vacuum System** separates the capsule caps and bodies.
- The **Powder Hopper** contains the mix that will be encapsulated.
- The **Auger** distributes the mix into the Tooling station and into the capsule bodies.
- The **Tamping Station** compresses the powder into a slug, which then gets pushed into the capsule body.

Control Console



1. Emergency Stop
2. Isolator Switch

Main Digital Control Console

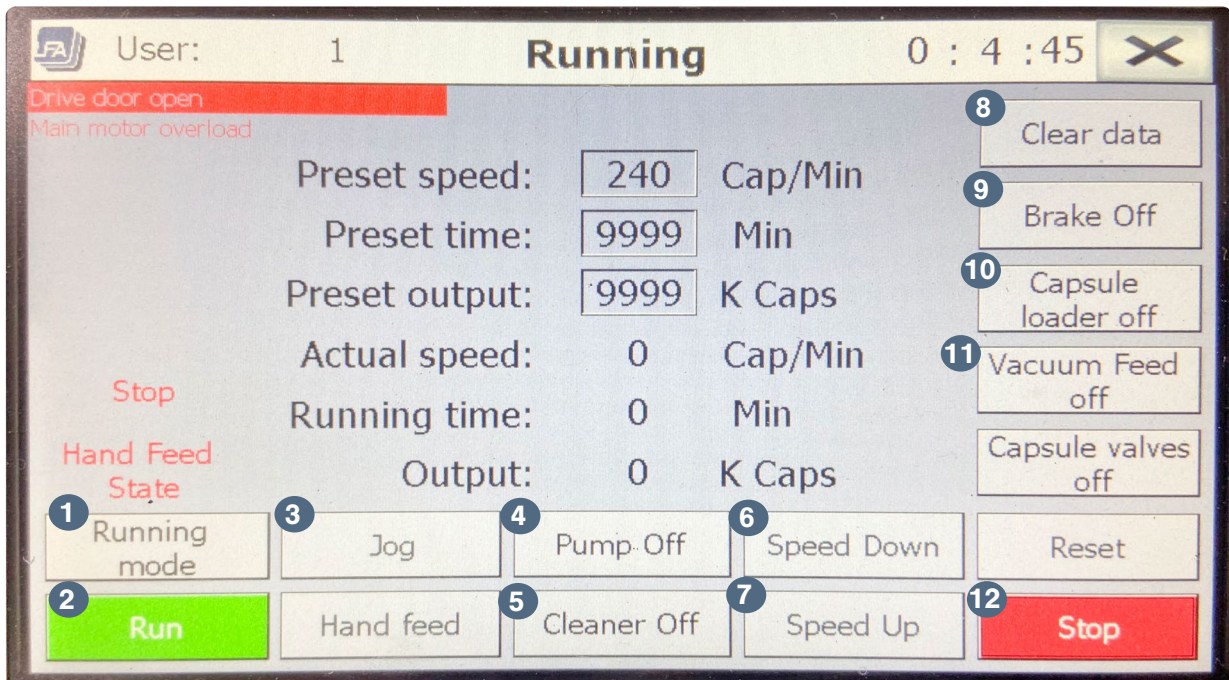

1. Switch between manual and automatic.
2. Start machine operation.
3. Operate machine in small increments.
4. Start/stop vacuum pump.
5. Start/stop capsule polisher (if using).
6. Increase operation speed.
7. Decrease operation speed.
8. Erase preset speed, preset time, actual speed, running time, and output.
9. Start/stop machine brake.
10. Start/stop capsule magazine.
11. Start/stop powder feeder.
12. Stop machine operation.

FACF® Range Process

The basic mechanism of the FACF® range involves orienting, separating, filling, closing, and ejecting capsules.

Orienting and Inserting Capsules into the Capsule Die Segments

When the machine begins operation, the capsules in the Hopper are fed into the magazine vertically. With each movement of the machine, the gate of the Capsule Magazine releases one capsule, and the horizontal forks orientate it. Then, the vertical forks push the capsules into the Capsule Die Segments with all caps in the upward position.

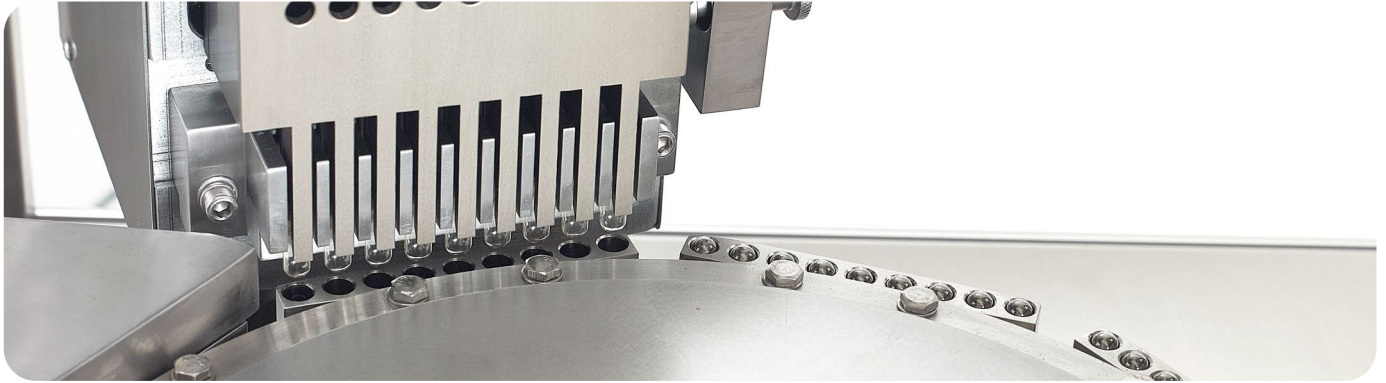

Filling the Capsule Bodies with Powder

After the vacuum system separates the capsule bodies and capsule caps, the lower Capsule Die Segment with the capsule bodies is extended. The filling rod then pushes the pressed powder slug in the capsule bodies.



Capsule Sealing and Ejection

Once defective capsules have been rejected, the capsules are snapped shut. After that, the finished capsules are ejected and then cleaned by the vacuum cleaner and compressed air.



How to Fill Capsules with the FACF® Range

Tools and Materials Needed

- Empty capsules
- Raw material formulation
- Fully assembled FACF®
- Receptacle for filled capsules
- Safety goggles
- Disposable latex/rubber gloves (for food grade products and to protect hands from grease)
- Hairnet and/or beard net (food grade products only)
- Sterile shoe covers (food grade products only)

CAUTION – PRIOR TO OPERATING MACHINE: Check to see that all four panel doors of the machine are completely shut (there are sensors on them that prevent the machine from running if any panel door is open).



Manually rotate for 1-3 cycles. Then, press the green button, push the vacuum pump button on the touch screen and check the direction of the rotation.

Ensure that there is a sufficient amount of powder in the Powder Hopper.

Ensure to start the vacuum pump first before starting the main motor.

Instructions

Note: Wear latex/rubber gloves (and appropriate food grade attire if applicable) during this process.

1. Place the receptacle for filled capsules near the ejection chute.
2. Pour the empty capsules into the Capsule Hopper.
3. Turn the Isolator Switch to power on the machine.



4. Press the language button to enter the main screen.

4.1 Note: There are two logins for operators of this machine. The login information is:

Username: 1 Password: 111

Username: 2 Password: 222

5. Press Run to operate the machine.

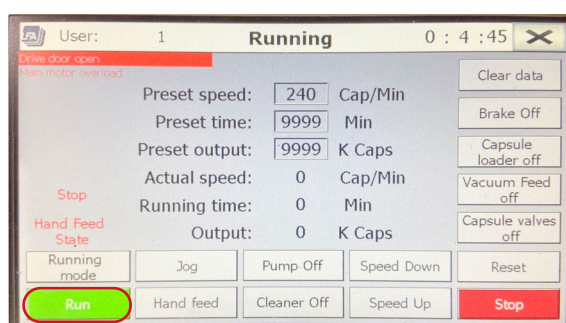

Settings and Adjustment

The FACF® range's settings can be adjusted. Tuning the machine can help with changing the capsule dose and machine operation.

Main Speed

The FACF® range's main speed for capsule output can be adjusted in both automatic and manual modes.

Tools and Materials Needed

- Disposable latex/rubber gloves (for food grade products and to protect hands from grease)
- Hairnet and/or beard net (food grade products only)
- Sterile shoe covers (food grade products only)

Instructions

Note: Wear latex/rubber gloves (and appropriate food grade attire if applicable) during this process.

1. Run the machine.
2. Press Speed Down or Speed Up to adjust the operation speed.

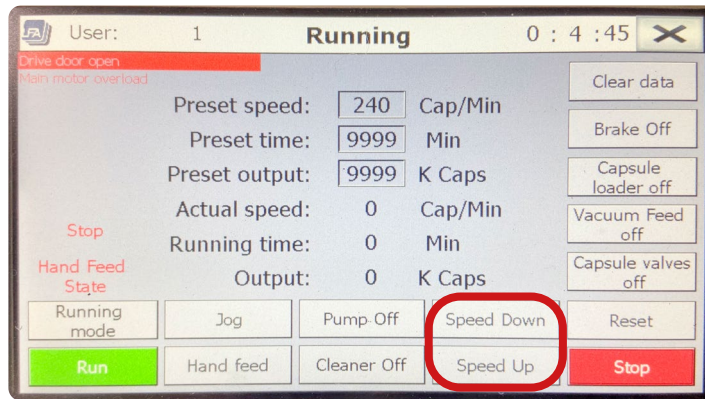

3. Ensure that the ejected capsules have a consistent weight after the adjustment.
 - 3.1 Note: Powders with poor flow will have issues with increased speed.

Main Start Delay, Automatic Filling Time, and No Filler Delay Stop

These adjustments are explained below:

- **Main Start Delay** - This is the amount of time that the machine will wait before starting the main rotation of the Tamping Station and the Capsule Die Segments (the vacuums, auger, and compressor will run first). It should be normally set at 0.5 seconds; however, if the first capsules in rotation are not separating correctly, increase the delay.
- **Automatic Feeding Time** - This is the number of seconds that the auger will rotate before pausing. This will need to be reduced if the auger is overfilling the Tamping Station. If the capsule weights are inconsistent, the sensor's height needs to be raised and the auger's running time needs to be increased in the range of 3-20 seconds.
- **No Filler Delay Stop** - This is the when the machine will automatically shut off if powder is not registered by the sensor in the Tamping Station. If the machine is shutting off with the alarm that states the machine has run out of powder, then the No Filler Delay Stop needs to be increased. Always ensure that the Powder Hopper is full and that the alarm is not being set off because it is actually out of powder before increasing this adjustment.

Tools and Materials Needed

- Disposable latex/rubber gloves (for food grade products and to protect hands from grease)
- Hairnet and/or beard net (food grade products only)
- Sterile shoe covers (food grade products only)

Instructions

Note: Wear latex/rubber gloves (and appropriate food grade attire if applicable) during this process.

1. Run the machine to determine the adjustment.
2. Press the Parameter Set button from the main screen.

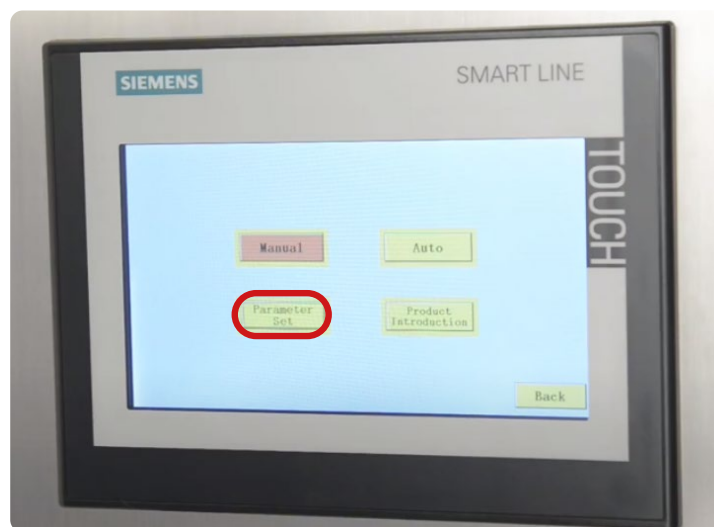

3. Input the seconds for each of the parameters.

3.1 Note: If the powder is fluffy and flour-like, it might need a few extra seconds to make its way down into the Hopper. To make this happen, increase the parameter delays.

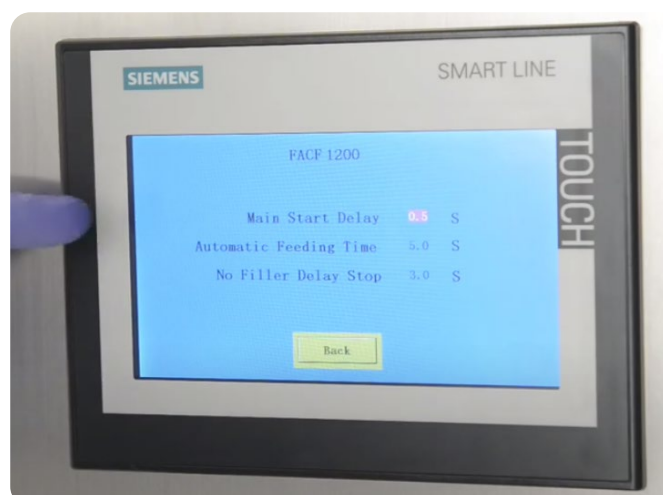

Capsule Weight Adjustment

Tuning the FACF® range involves adjusting the five tamping stations located below the Powder Hopper. The weight of the capsule can be increased or decreased by making these adjustments. To watch a video of tuning the FACF®, go to <https://www.lfacapsulefillers.com/videos/tuning-your-fac-capsule-filler>

Tools and Materials Needed

- Metric wrench set
- Permanent marker
- Disposable latex/rubber gloves (for food grade products and to protect hands from grease)
- Hairnet and/or beard net (food grade products only)
- Sterile shoe covers (food grade products only)



WARNING: To prevent any potential personal injury, ALWAYS unplug the FACF® from the electrical outlet when making adjustments.

Instructions

Note: Wear latex/rubber gloves (and appropriate food grade attire if applicable) during this process.

1. Open the machine's panel doors and insert the lever onto the motor.
2. Pull forward the lever and turn the hand wheel to operate the machine manually to determine the capsule weight adjustment.

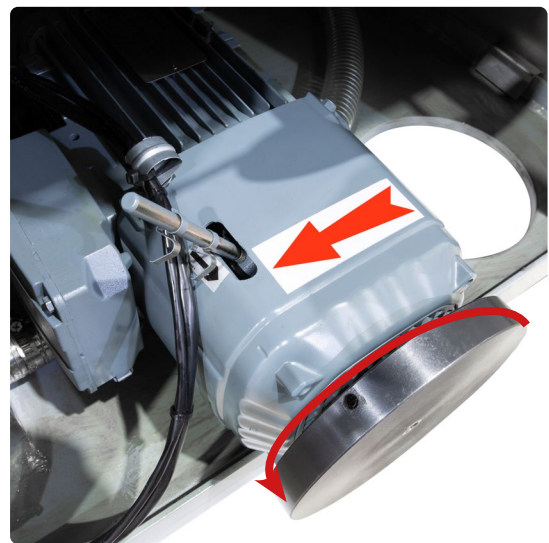

3. Loosen each station's adjustment bolt with a wrench.



NOTE: Read this before making adjustments. The capsule weight adjustment knobs **MUST** be turned sequentially with #5 being the highest and #1 being the lowest. To help with remembering the correct order, mark each knob as follows and adjust each in that order:



4. Turn each adjustment knob sequentially an equal amount of times.

4.1 Note: Raise the knobs to decrease the weight and lower them to increase the weight.

5. Tighten each station's adjustment bolt with a wrench.

6. Manually operate the machine to determine if weight adjustment is correct.



WARNING: To prevent any potential personal injury, remove the Handle from the Motor before plugging in machine and automatic operation.

Capsule Hopper Adjustment

This adjustment affects the flow of the capsules from the Capsule Hopper to the Capsule Magazine. If the flow rate is too high, capsules can spill over. If it is too low, capsules will not enter the Capsule Die Segments.

Tools and Materials Needed

- Disposable latex/rubber gloves (for food grade products and to protect hands from grease)
- Hairnet and/or beard net (food grade products only)
- Sterile shoe covers (food grade products only)



WARNING: To prevent any potential personal injury, ALWAYS unplug the FACF® from the electrical outlet when making adjustments.

Instructions

Note: Wear latex/rubber gloves (and appropriate food grade attire if applicable) during this process.

1. Rotate the lock to loosen the Capsule Hopper's gate.



2. Slide the gate up and/or down to adjust the capsule flow.

2.1 Note: Sliding the gate up increases the flow of the capsules. Sliding the gate down decreases the flow of the capsules.

Capsule Feeding Gate Adjustment

The correct timing of the retaining gate ensures that one capsule comes out of the magazine fork at a time.

Tools and Materials Needed

- Set of Allen keys with ball ends
- Disposable latex/rubber gloves (for food grade products and to protect hands from grease)
- Hairnet and/or beard net (food grade products only)
- Sterile shoe covers (food grade products only)



WARNING: To prevent any potential personal injury, ALWAYS unplug the FACF® from the electrical outlet when making adjustments.

Instructions

Note: Wear latex/rubber gloves (and appropriate food grade attire if applicable) during this process.

1. Remove the fastening screws with an Allen key.
2. Adjust the limit block until one capsule is correctly Discharged from the magazine at a time.
 - 2.1 Note: Raise the limit block up and away from the Capsule Magazine if not enough capsules are coming out. Adjust it down and towards the Capsule Magazine if too many capsules are coming out. If only one track of the Capsule Magazine is not putting out capsules, one of the springs may be bent.

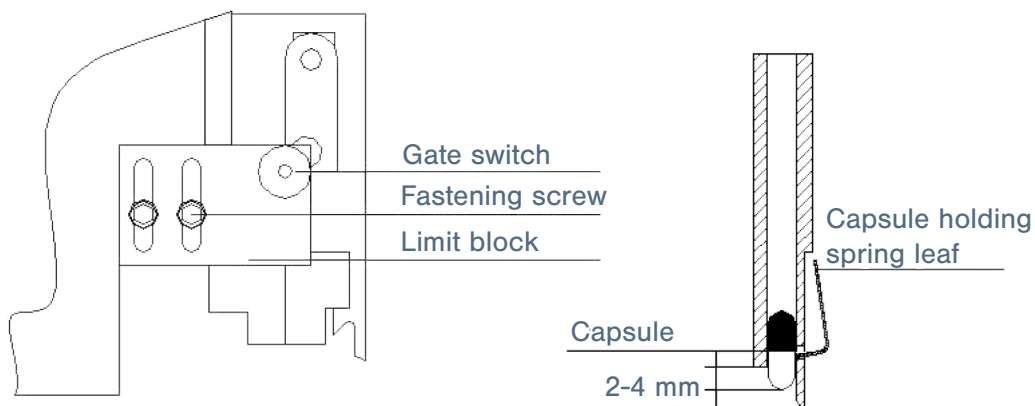

Brass Ring Calibration

The gap between the Dosing Disk and the brass seal ring should be between 0.05 mm to 0.1 mm. If the powder's granules are large, the gap should be increased as a smaller gap could cause resistance between the Dosing Disk and seal ring. Powder leakage can also indicate if the gap is too large.

Tools and Materials Needed

- Crosshead screwdriver
- Set of Allen keys with ball ends
- Set of metric wrenches
- Feeler gauge
- Disposable latex/rubber gloves (for food grade products and to protect hands from grease)
- Hairnet and/or beard net (food grade products only)
- Sterile shoe covers (food grade products only)



WARNING: To prevent any potential personal injury, ALWAYS unplug the FACF® from the electrical outlet when making adjustments.

Instructions

Note: Wear latex/rubber gloves (and appropriate food grade attire if applicable) during this process.

1. Remove the Powder Hopper from the machine and remove the excess powder.
2. Pull out the sensor from the inside of the Tamping Turret.



3. Remove the bolts and washers from the top of the Tamping Turret with a wrench.

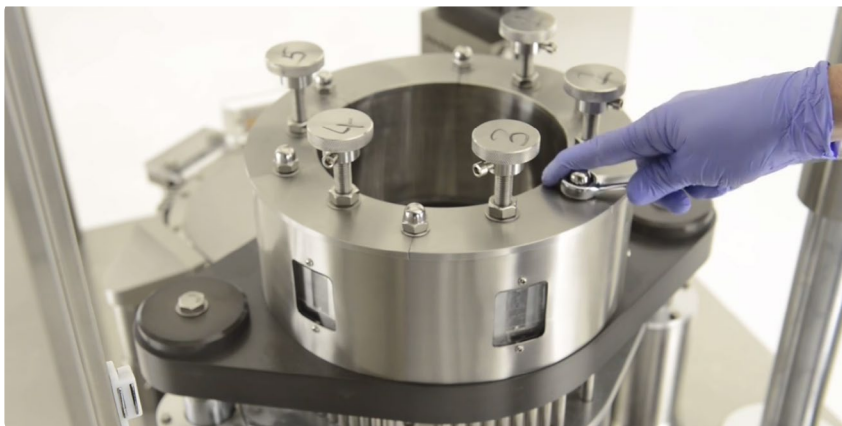

4. Carefully pull up each station to remove the Tooling.

4.1 Note: Ensure not to damage the fragile ends of the Tamping Pins.



5. Lift up the extra panel, the inner metal casing, and outer metal casing and set aside.

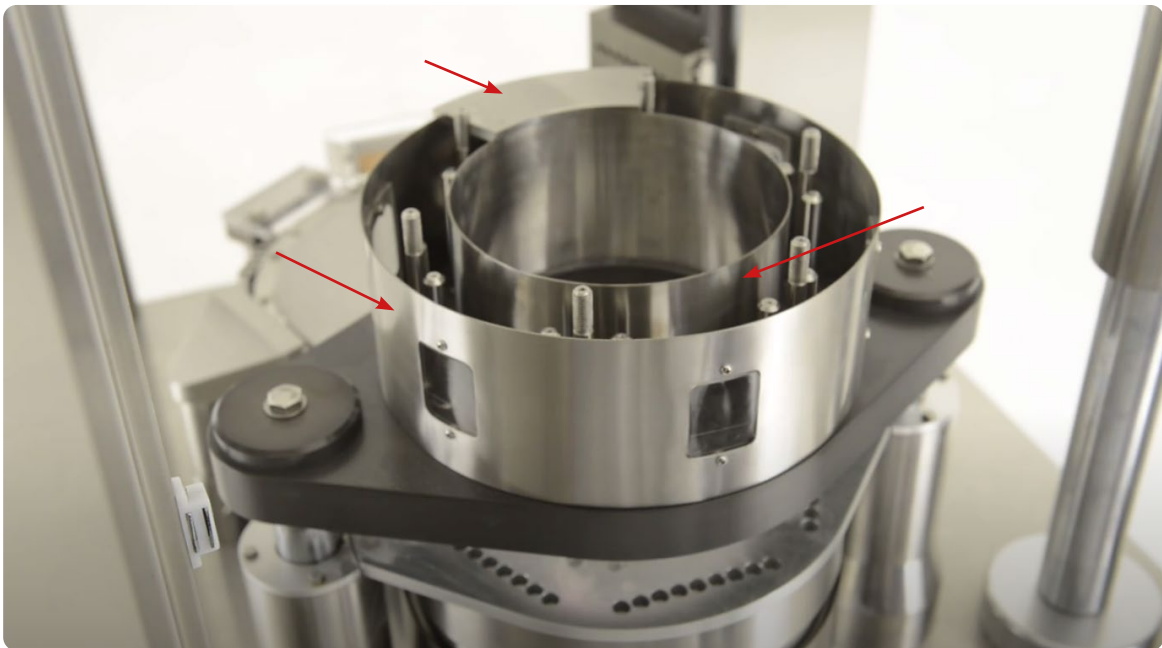

6. Remove the bolt with a wrench and carefully lift up the block.
6.1 Note: Ensure not to lose the brass spacer.



7. Remove both bolts from the sides and lift up the middle section of the Tamping Turret.

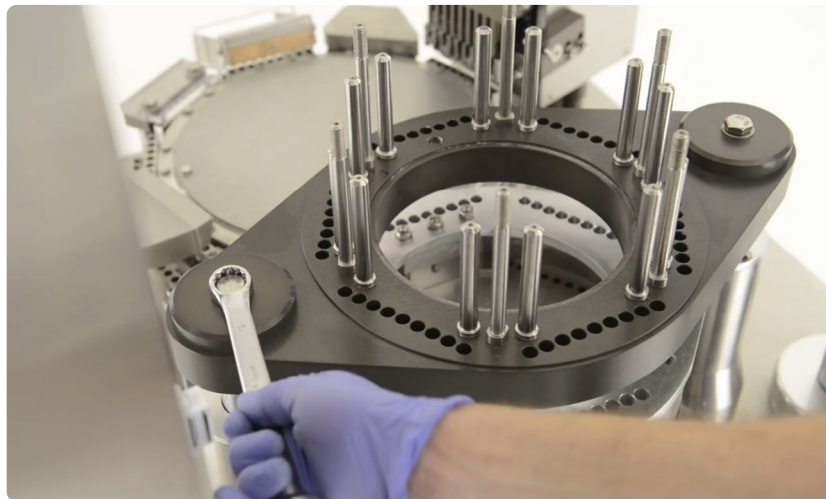

8. Remove the four bolts from the Tamping Pins Guide Runner with a wrench and lift it up.



9. Remove the bottom three bolts of the Tamping Bowl with the special tool included in the Toolkit.



10. Remove the protective cover around the base of the tamping section with a crosshead screwdriver.

11. Loosen the five bolts located around the the midsection of the Tamping Turret with a wrench.



12. Rotate the adjustment bolts to adjust the brass ring.

12.1 Note: Rotating the adjustment bolts counterclockwise to raise the brass ring and close the gap between the Tamping Bowl. Rotating the adjustment bolts clockwise lowers the brass ring.



13. Lower the adjustment bolts until there is a 1 mm gap between the Tamping Bowl and brass ring and fasten the three bolts on the Tamping Bowl.

13.1 Note: If fastening these three bolts closes the gap, repeat step 12.

14. Insert a feeler gauge in between the gap of the Tamping Bowl and brass ring.

14.1 Note: The brass ring and the Tamping Bowl should not be touching. The minimum recommended gap is .02 mm and the maximum recommended gap is 1 mm. Increasing the gap will extend the life of the brass ring but could potentially lead to more powder waste.



15. Raise the adjustment bolts near where the feeler gauge is between the Tamping Bowl and brass ring until the feeler gauge is pinched and can not be moved.

16. Repeat step 15 for the remaining adjustment bolts until it is evenly spaced.

17. Resecure the adjustment bolts and with the locking nuts with a wrench.

18. Resecure the protective cover with a crosshead screwdriver.

Powder Scraper Adjustment

Anytime the Dosing Disk is replaced, the gap between the powder scraper and the Dosing Disk must be adjusted. The optimal measurement of the gap is 0.05 mm to 0.1 mm.

Tools and Materials Needed

- Set of Allen keys with ball ends
- Set of metric wrenches
- Feeler gauge
- Disposable latex/rubber gloves (for food grade products and to protect hands from grease)
- Hairnet and/or beard net (food grade products only)
- Sterile shoe covers (food grade products only)



WARNING: To prevent any potential personal injury, ALWAYS unplug the FACF® from the electrical outlet when making adjustments.

Instructions

Note: Wear latex/rubber gloves (and appropriate food grade attire if applicable) during this process.

1. Remove the Powder Hopper from the machine and remove the excess powder.
2. Loosen the fixed screws that are above and under the cover plate.

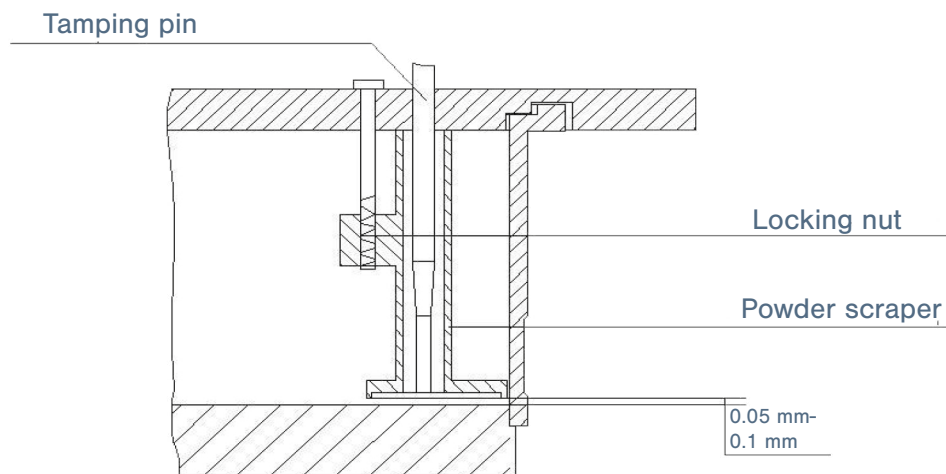

3. Rotate the adjusting screw to raise or lower the powder scraper.
4. Measure the gap with a feeler gauge to ensure that it is between 0.05 mm and 0.1 mm.
5. Tighten the fixed screws after determining the correct adjustment.

Powder/Capsule Sensor Calibration

If the machine's sensor is unable to detect powder or capsules, its sensitivity must be calibrated.

To view the sensor's manual, go to https://drive.google.com/file/d/1k_Zr8UbNfU4Gyuv6iGFYL6hizGdihX62/view?usp=sharing

Tools and Materials Needed

- Set of Allen keys with ball ends
- Set of metric wrenches
- Metric ruler
- Disposable latex/rubber gloves (for food grade products and to protect hands from grease)
- Hairnet and/or beard net (food grade products only)
- Sterile shoe covers (food grade products only)



WARNING: To prevent any potential personal injury, ALWAYS unplug the FACF® from the electrical outlet when making adjustments.

Instructions

Note: Wear latex/rubber gloves (and appropriate food grade attire if applicable) during this process.

1. Loosen the sensor from the powder/capsule Hopper.
2. Unlock the sensor by holding down both buttons.

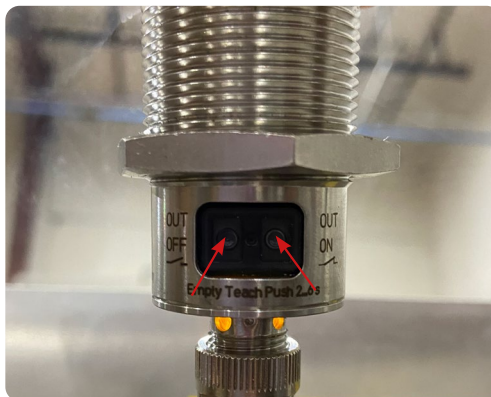

2. Press the OUT ON button for two seconds.

2.1 Note: Ensure that nothing is within 20 mm (1 in) of the sensor while pressing the button.



Capsule Closing Adjustment

If capsules are not sealing, adjust the upper closing plate and the lower pushing rod in the 10th station.

Tools and Materials Needed

- Set of Allen keys with ball ends
- Set of metric wrenches
- Metric ruler
- Disposable latex/rubber gloves (for food grade products and to protect hands from grease)
- Hairnet and/or beard net (food grade products only)
- Sterile shoe covers (food grade products only)



WARNING: To prevent any potential personal injury, ALWAYS unplug the FACF® from the electrical outlet when making adjustments.

Instructions

Note: Wear latex/rubber gloves (and appropriate food grade attire if applicable) during this process.

1. Loosen the upper plate's screws to adjust the height.
 - 1.1 Note: Ensure that the distance between the plate and the top of the capsule is 0.2 mm-0.3 mm.

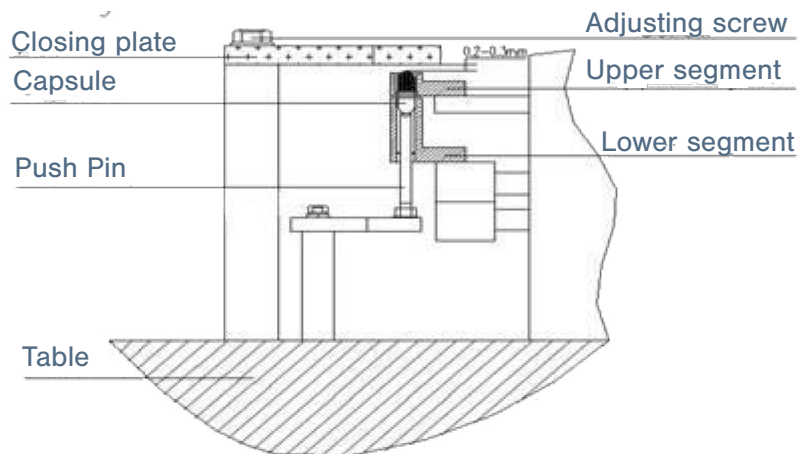

2. Insert an empty capsule into the Capsule Die Segment and manually rotate the machine by hand to move the pushing rod to the highest position.
3. Loosen the screws at both ends of the pushing rod and turn it to push up the capsule.
4. Tighten the screws whenever the capsule touches the closing plate and the pushing rod is at its highest point.

Note: The Capsule Sealing Alignment Pins that are included in the FACF® toolbox can also help with adjusting the capsule closing section. Drop the two pins in the outer bores of the upper and lower capsule sealing segments. Adjust the push pins until the Capsule Sealing Alignment Pins easily fall into the segment bores.

Filled Capsule Ejection Adjustment

The adjustment of the ejection mechanism in the machine includes the guide plate and the pushing rod.

Tools and Materials Needed

- Set of Allen keys with ball ends
- Set of metric wrenches
- Disposable latex/rubber gloves (for food grade products and to protect hands from grease)
- Hairnet and/or beard net (food grade products only)
- Sterile shoe covers (food grade products only)



WARNING: To prevent any potential personal injury, ALWAYS unplug the FACF® from the electrical outlet when making adjustments.

Instructions

Note: Wear latex/rubber gloves (and appropriate food grade attire if applicable) during this process.

1. Loosen the guide plate's screws and move them to adjust the angle and position of capsule ejection.

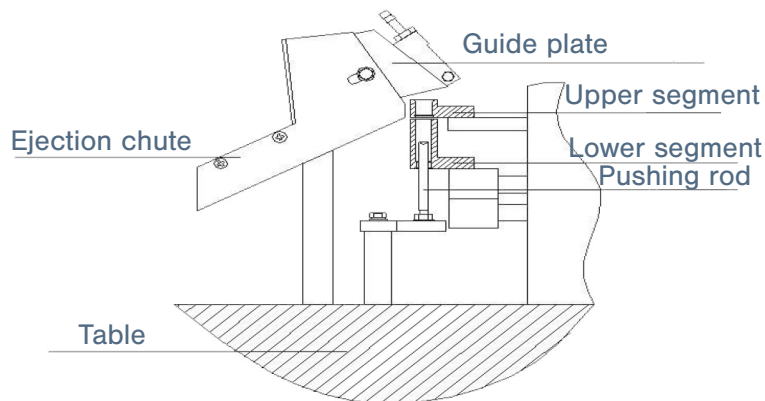

2. Loosen the screws at both ends of the pushing rod and turn it to adjust the ejection.
 - 2.1 Note: Please refer to the remove and replace Tooling instructions on page 50 for further information regarding the sensor.

Timing Calibration

Calibrating the machine means checking the positions of the Die Segment Turret, Dosing Disk, Tamping Pins, and Sealing Pins, Ejection Pins, and Rejection Pins, which may require an adjustment of the position indicator.

Tools and Materials Needed

- Set of Allen keys with ball ends
- Set of metric wrenches
- Disposable latex/rubber gloves (for food grade products and to protect hands from grease)
- Hairnet and/or beard net (food grade products only)
- Sterile shoe covers (food grade products only)



IMPORTANT: The timing calibration **MUST** be adjusted in the following order:

1. Die Segment Turret
2. Dosing Disk
3. Tamping Pins
4. Sealing Pins, Ejection Pins, and Rejection Pins

Instructions

Note: Wear latex/rubber gloves (and appropriate food grade attire if applicable) during this process.

Part One: Die Segment Turret Timing and Set Up for Other Calibrations

1. Turn the isolator switch to power the machine.



2. Press the Brake button on the HMI.
3. Rotate the machine by hand until the Die Segment Turret just begins to move.



4. Check the position indicator to ensure that the Die Segment Turret is at 360/360 degrees.
4.1 Note: If it is not at this position, remove the bolt in the middle of the position indicator with an Allen key. Adjust the position indicator until it is at the correct degree and tighten its screw with an Allen key.



Part Two: Dosing Disk Timing

5. Manually rotate the machine until the position indicator is at 300 degrees.
6. Check to see that the Dosing Disk begins to move.



- If the Dosing Disk moves, skip to step #10. If it does not move, proceed to step #7.
7. Loosen the lock screw and disconnect the chain from the chain joint.

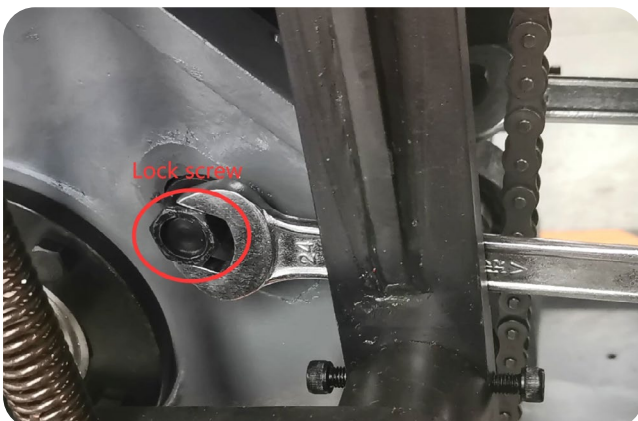

8. Rotate the Tamping Section gearbox until it begins to move.

8.1 Note: Do NOT turn the gearbox that is connected to the Die Segment Turret.

9. Reconnect the chain to the main drive motor.

9.1 Note: Ensure NOT to move either gearbox. Causing any more movement during this step can disrupt the calibration, which would require the entire process to start over from the beginning.

Part Three: Adjust Tamping Pins Timing

10. Manually rotate the machine until the position indicator is at 20 degrees.

11. Check to see that the Tamping Pins begin to move upwards. If it does not, move the Tamping Pin Cam until it is in the correct position.

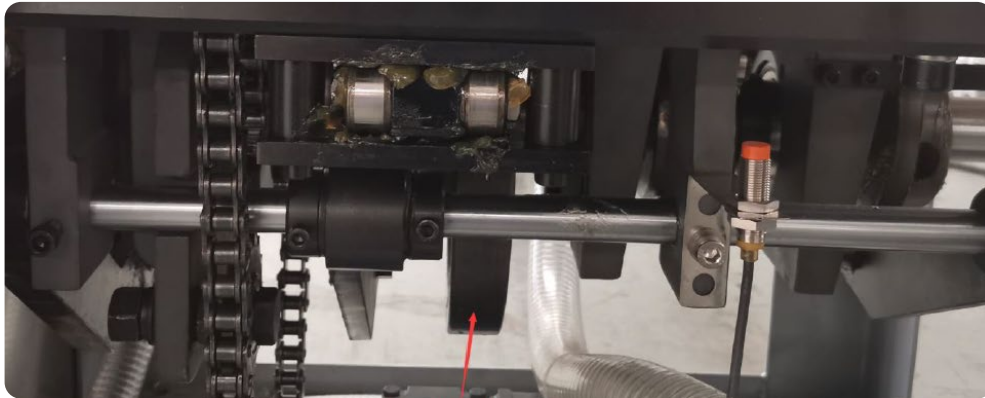

Part Four: Adjust the Cams

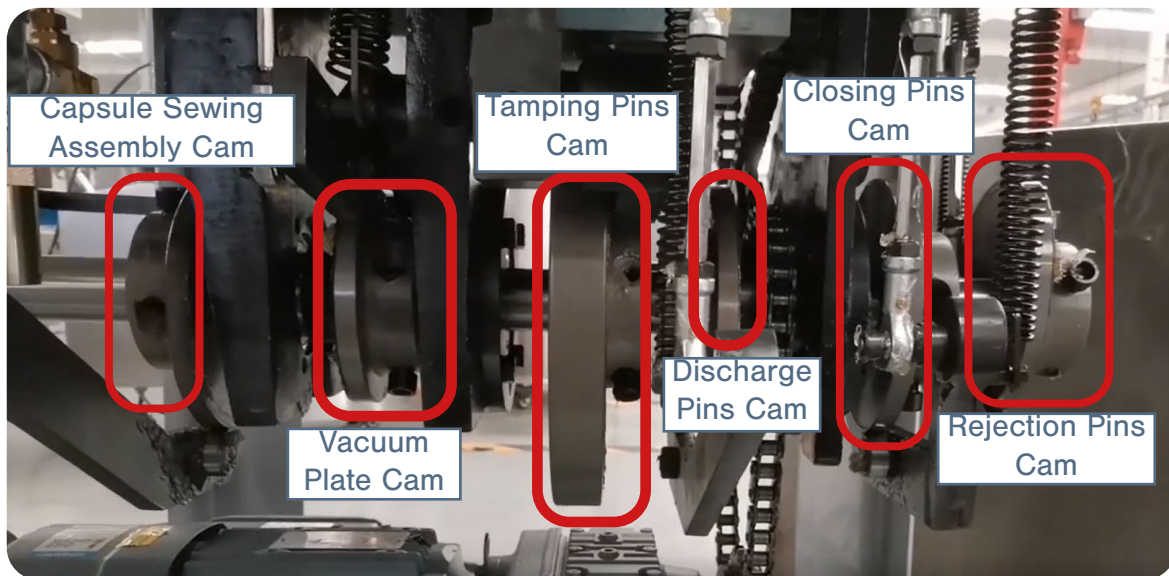

Part Five: Adjust Capsule Sewing Assembly Cam Timing

12. Inch the machine to find the 2 convex lock screws on the cam and loosen them with an Allen key.

12.1 Note: This process is the same for all of the cams' timing calibration.

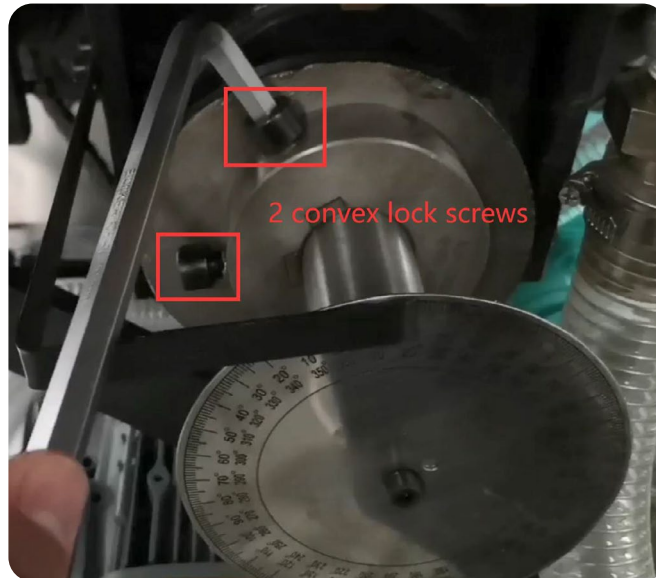

13. Continue to inch the machine to find the 2 concave screws and loosen them with an Allen key.

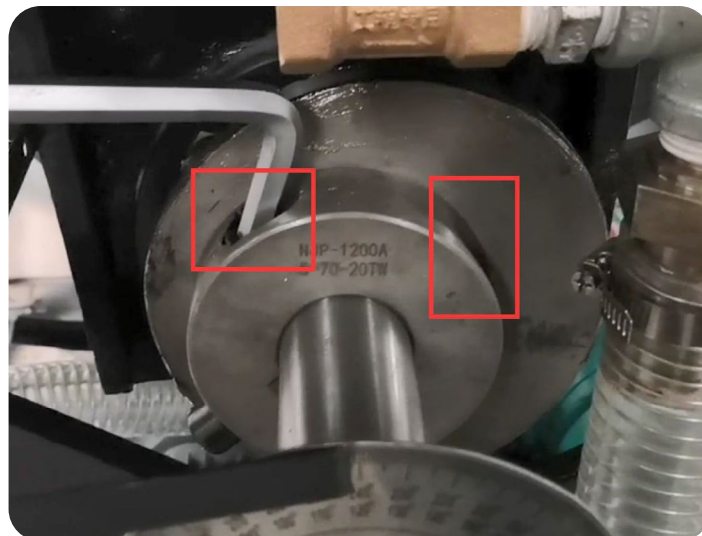

14. Rotate the cam to adjust the position of the capsule fork.

14.1 Note: Ensure that the capsule fork is at its highest point.

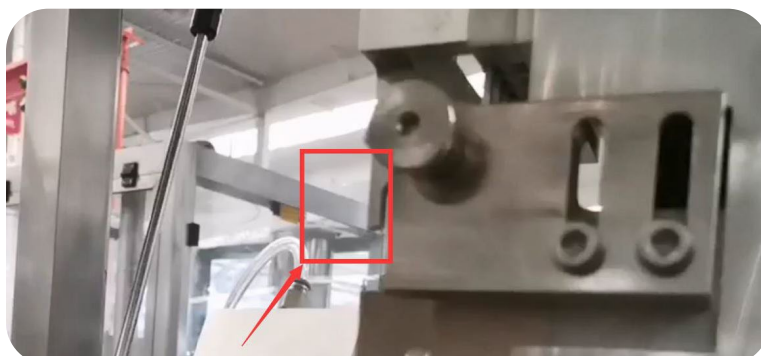

15. Once adjusted, hold the cam and secure the convex and concave screws back into the cam with an Allen key.

Part Six: Adjust Vacuum Plate Timing Cam

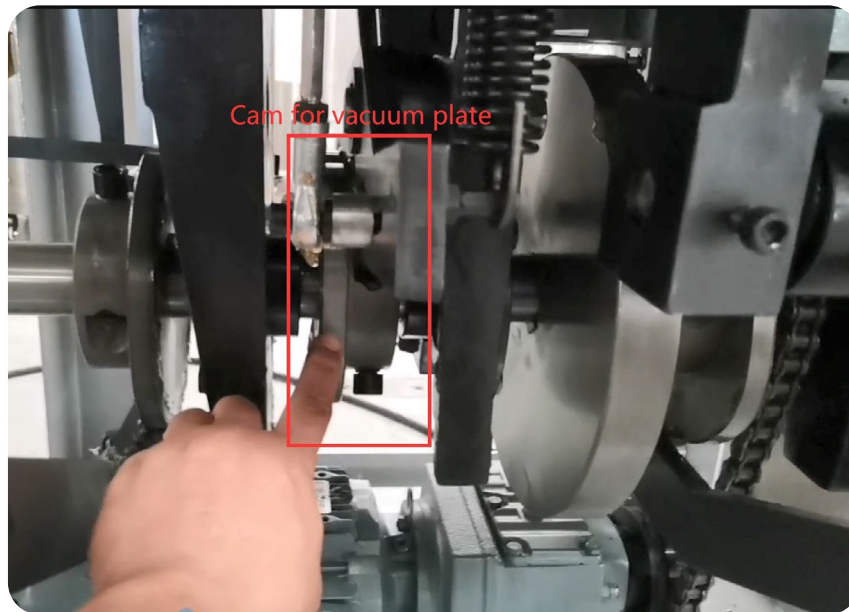

16. Inch the machine to find the 2 convex lock screws on the cam and loosen them with an Allen key.

16.1 Note: This process is the same for all of the cams' timing calibration.

17. Inch the machine to find the 2 concave lock screws on the cam and loosen them with an Allen key.

18. Inch the machine until the segment is right above the vacuum plate.



19. Rotate the cam so that the vacuum plate begins to raise from the lowest point into the die segment.



20. Once the vacuum plate begins to raise, hold the cam and secure the convex and concave screws back into the cam with an Allen key.

Part Six: Adjust Discharge Pins, Closing Pins, and/or Rejection Pins Cam Timing

Note: This process works for each cam.

21. Inch the machine so that the segments begin to move.

The Discharge Pins should be closing and the Closing Pins and Rejection Pins should be at their lowest points.

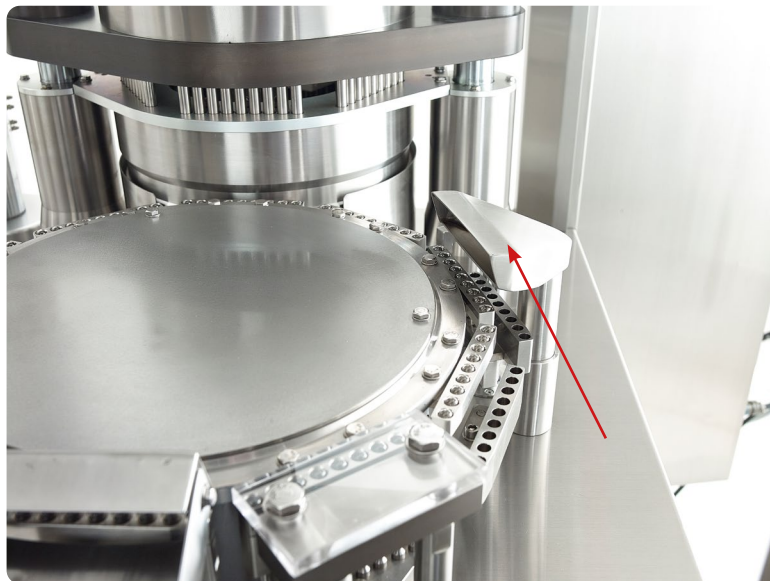
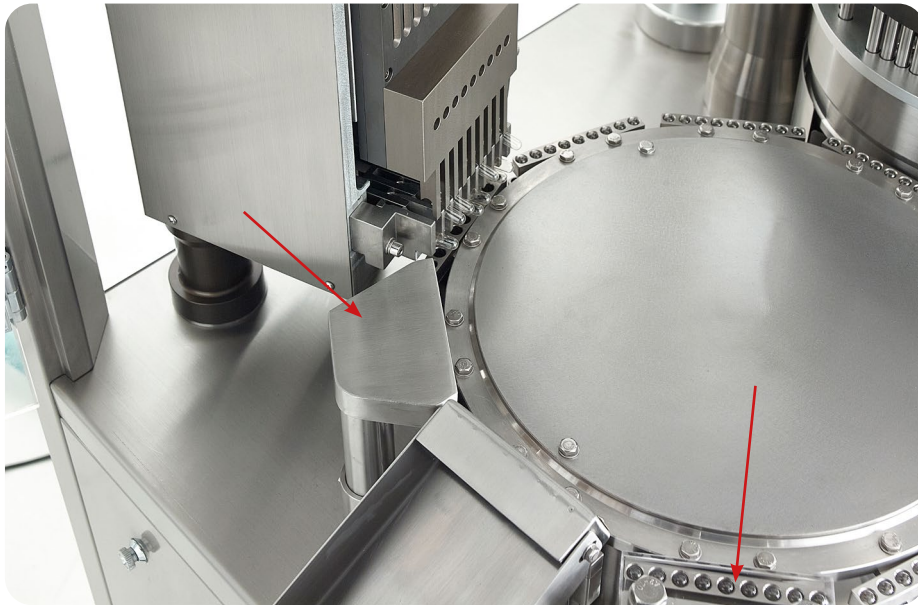

22. Find the cam that is out of calibration.

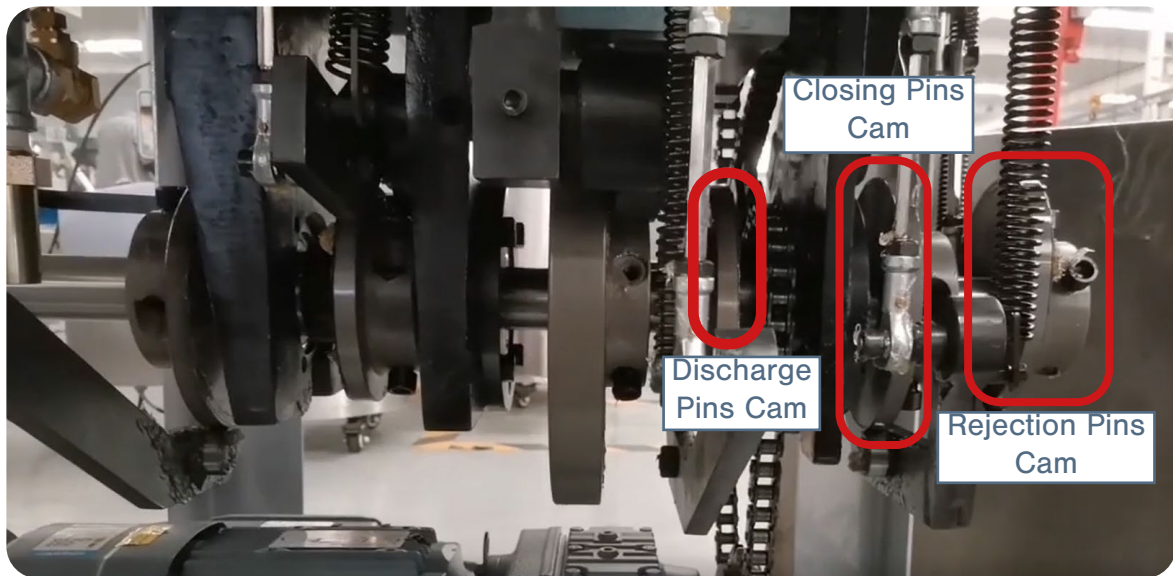

23. Inch the machine to find the 2 convex lock screws on the cam and loosen them with an Allen key.

24. Inch the machine to find the 2 concave lock screws on the cam and loosen them with an Allen key.

25. Inch the machine to move the segments.

26. Rotate the cam until the Discharge Pins/Closing Pins/Rejection Pins reach the lowest point.

26.1 Note: Photo below is of the Discharge Pins.



27. Once the Discharge Pins/Closing Pins/Rejection Pins are at their lowest point, hold the cam and secure the convex and concave screws back into the cam with an Allen key.

Capsule Sewing Pump Pressure

The capsule sewing section's vacuum pump pressure affects whether or not the capsules are correctly separated in their segments. To ensure that the vacuum pump pressure is in the accurate range, two different methods of adjustments can be made.

To view the vacuum pump motor's manual, go to <https://drive.google.com/file/d/10GdpVFv2BhxLGS1gPkGQYyhqHqdmA4HE/view?usp=sharing>

Tools and Materials Needed

- Disposable latex/rubber gloves (for food grade products and to protect hands from grease)
- Hairnet and/or beard net (food grade products only)
- Sterile shoe covers (food grade products only)



WARNING: To prevent any potential personal injury, ALWAYS unplug the FACF® from the electrical outlet when making adjustments.

Instructions

Note: Wear latex/rubber gloves (and appropriate food grade attire if applicable) during this process.

Method One: Turn the Pressure Dial on the Vacuum Pump Motor

1. Rotate the pressure dial on the vacuum pump to adjust the pressure.
 - 1.1 Note: The pressure gauge needs to be in between 0.06 MPa and 0.04 MPa.



Note: The vacuum should only be used for separating the capsules, not for guiding them into the die bores.

Capsule Segment Calibration

Sometimes the upper and lower capsule segments become too tight, which affects their alignment and machine operation. Using the alignment pins to properly calibrate the segments fixes this issue.

Tools and Materials Needed

- Set of metric Allen keys with ball ends
- Set of metric wrenches
- Disposable latex/rubber gloves (for food grade products and to protect hands from grease)
- Hairnet and/or beard net (food grade products only)
- Sterile shoe covers (food grade products only)



WARNING: To prevent any potential personal injury, ALWAYS unplug the FACF® from the electrical outlet when making adjustments.

Instructions

Note: Wear latex/rubber gloves (and appropriate food grade attire if applicable) during this process.

1. Open the Perspex Casing's doors.
2. Remove the top of the Die Segment Turret with a wrench.



2. Loosen the bolts on the tamping pins.



3. Carefully pull up each station to remove the Tooling.

3.1 Note: Ensure not to damage the fragile ends of the Tamping Pins.



4. Lift up the extra panel, the inner metal casing, and outer metal casing and set aside.



5. Remove the bolt with a wrench and carefully lift up the block.
5.1 Note: Ensure to not lose the brass spacer.

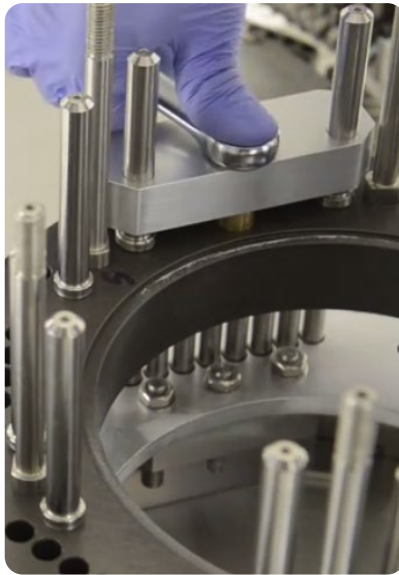

6. Ensure that the Tamping Turret is fully down and making contact with the Dosing Disk.
7. Insert the Dosing Disk Alignment Pins through the Dosing Disk, Tamping Turret, and bottom segment.
8. Loosen the segment's bolts with an Allen key.



9. Adjust the segment using the Dosing Disk Alignment Pins and secure when finished.

Maintenance

To ensure that the FACF® will have a long operational life, maintenance is essential. This section includes methods for replacing parts, troubleshooting solutions, and how often to grease and clean your machines to keep its performance optimal.

General Maintenance Prescriptions

- Use the maintenance checklist (found in the Appendix) before, during, and after machine operation.
- Make sure all grease points are maintained and regularly lubricated.
- Use an appropriate amount of lubricant. Excess grease can drip into the capsules.
- Before reassembling the machine after cleaning, make sure that the parts are dried and oiled.
- Constantly check for any loose nuts and/or screws before, during, and after machine operation.
- If the machine is not used for more than a week, place the Tooling in a container and cover in lubricant.
- Regularly measure capsules' lengths with calipers to ensure they are consistent. If they are different lengths, it can affect the sewing and sealing of the separated capsules.

Lubrication

Regularly greasing your machine is vital to prolonging its operational life. Parts that are not greased properly can make the machine seize up and cause major problems later. LFA recommends maintaining a lubrication schedule for your FACF®, which can be found in this section.

Tools and Materials Needed

- Hydraulic oil ISO VG 46 (use H1 NSF for food grade products)
- NLGI grade 1 grease (use H1 NSF for food grade products)
- Set of metric Allen keys with ball ends
- Disposable latex/rubber gloves (for food grade products and to protect hands from grease)
- Hairnet and/or beard net (food grade products only)
- Sterile shoe covers (food grade products only)



WARNING: To prevent any potential personal injury, unplug the FACF 1200® from the electrical outlet.

Instructions



Note: Wear latex/rubber gloves (and appropriate food grade attire if applicable) during this process.

1. Apply one layer of grease onto the work surface of the cams and rollers.
 - 1.1 Note: To see drawings of lubrication point locations, please refer to the Lubrication Schedule on page 46.
2. Apply lubrication oil to joint bearings, sealing bearings, and sliding guides.
3. Grease the ball bearings, needle bearing, and linear bearings.
4. Check the driving chains' tightness and apply lubricant.
5. Replenish the oil of the main driving and feeder decelerators.

Lubrication Schedule

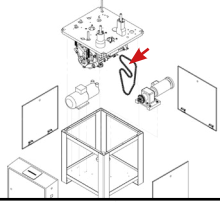
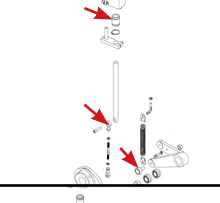
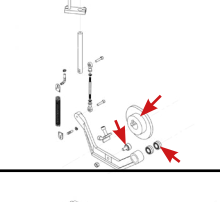
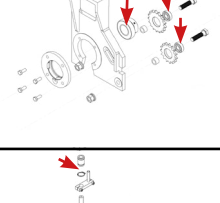
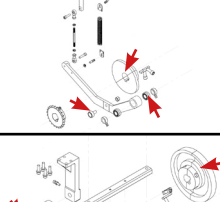
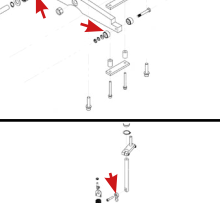
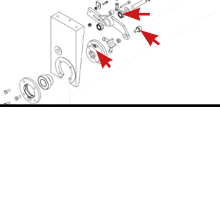
LFA recommends the following FACP® range parts to be lubricated according to the following frequency:

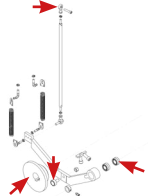
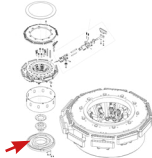
Location	Parts	Image	Frequency	Type of Lubricant
Driving Part Assembly	<ul style="list-style-type: none"> Chain 		Visually inspect chain and apply when dry (approximately weekly).	Oil or grease
Rejection Driving Assembly	<ul style="list-style-type: none"> Cam bearing Needle bearing Cam 		<p>Visually inspect bearings and apply when dry (regularly).</p> <p>Visually inspect cam and apply when dry (weekly).</p>	NLGI Grade 1
Press Driving Assembly	<ul style="list-style-type: none"> Cam bearing Needle bearing Cam 		<p>Visually inspect bearings and apply when dry (regularly).</p> <p>Visually inspect cam and apply when dry (weekly).</p>	NLGI Grade 1
Main Shaft Support Assembly	<ul style="list-style-type: none"> Deep groove ball bearing Spherical surface ball bearing 		Visually inspect bearings and apply when dry (regularly).	NLGI Grade 1
End Production Press Driving Assembly	<ul style="list-style-type: none"> Needle bearing Cam Linear bearing Cam bearing 		<p>Visually inspect bearings and apply when dry (regularly).</p> <p>Visually inspect cam and apply when dry (weekly).</p>	NLGI Grade 1
Dosing Driving Assembly	<ul style="list-style-type: none"> Cam bearings Needle bearings Cam 		<p>Visually inspect bearings and apply when dry (regularly).</p> <p>Visually inspect cam and apply when dry (weekly).</p>	NLGI Grade 1
Vacuum Driving Assembly	<ul style="list-style-type: none"> Cam bearing Needle bearing Cam Linear bearing Pin end bearing 		<p>Visually inspect bearings and apply when dry (regularly).</p> <p>Visually inspect cam and apply when dry (weekly).</p>	NLGI Grade 1

Location	Parts	Image	Frequency	Type of Lubricant
Sequence Driving Assembly	<ul style="list-style-type: none"> • Cam bearing • Needle bearing • Cam • Pin end bearing 		<p>Visually inspect bearings and apply when dry (regularly).</p> <p>Visually inspect cam and apply when dry (weekly).</p>	NLGI Grade 1
Round Table Seat Assembly	<ul style="list-style-type: none"> • Disk cam 		<p>Visually inspect cam and apply when dry (weekly).</p>	NLGI Grade 1
Top of Powder Hopper	<ul style="list-style-type: none"> • Feeding decelerator 		<p>Visually inspect and replenish when necessary. Replace entirely once every 6 months.</p>	Hydraulic oil ISO VG 46 (H1 NSF for food grade products)
Inside Machine Body near Motor	<ul style="list-style-type: none"> • Main drive decelerator 		<p>Visually inspect and replenish when necessary. Replace entirely once every 6 months.</p>	Hydraulic oil ISO VG 46 (H1 NSF for food grade products)

Dismantling for Repair and Replacement

Eventually due to wear and tear, some parts of the FACF® range will need to be removed for repair and replacement. To prevent any delays in your capsule production, it is best practice to keep extra parts just in case.

To buy a FACF® range part replacement, simply go to

<https://www.lfacapsulefillers.com/products/machine-spare-parts/facf-range-spare-parts>

Warranty

To access LFA's warranty policy, go to <https://www.lfacapsulefillers.com/warranty>

If your part is eligible for warranty, have your part's serial number on hand and please contact LFA:

UK

Phone

+44 01869 250234

Email

support.uk@lfamachines.com

USA

Phone

+1 (682) 312-0034

Email

support.usa@lfamachines.com

Taiwan

Phone

+886 422031790

Email

support.asia@lfamachines.com



WARNING: To prevent any potential personal injury, ALWAYS unplug the FACF® from the electrical outlet when replacing parts.

Wear Parts and Causes of Damage

Wear Part	Cause of Damage
Capsule Holding Pins	The Capsule Holding Pins are an integral part of the capsule sowing section. They hold the capsules in the cartridge and time their release. They can become damaged in the event of a jam, during cleaning, or if mishandled.
Bearings for Capsule Segment	Behind the casing to the capsule sewing section, there are 8 bearings that are used to maintain a smooth back/forward and up/down motion to orient and sew the capsules.
Plastic Inserts for Capsule Segment	The capsule segments rotate the Turret and are facilitated by plastic inserts. These segments can become worn, which can cause fine powder to leak.
Tamping Pins	The tamping pins are used to create the slug that is pushed into the body of the capsule before the cap is applied. Tamping pins might need replacing in the event of a hard stop or the product is seriously caustic or abrasive.
Tamping Pin Springs	The tamping pin springs are retained to the tamping pins. Over time these springs will go through a large amount of compressions and can lose their ability to hold the pins in the tamping pin blocks, which can affect capsule weights and protection in the event of a jam.
Dosing Disk Wear Ring	As the Dosing Disk rotates to create the slugs, it turns over the wear ring. This part is not only designed to help facilitate the movement of the Tamping Station, but also gives a flat surface for the slug to be formed against. Because of these two functions, the Dosing Disk will wear down over time.
Spacing Washer	The spacing washer calibrates the tamping pins. While it is unlikely that the spacing washer will need to be replaced due to damage, it is possible that it can be lost during cleaning or a machine strip down.
Capsule Ejection Springs	The capsule ejection springs are used to direct the capsules as they are pushed out of the machine. Sometimes they can become bent during cleaning or maintenance.

Tooling

If you want to change the size of a capsule, it is necessary to change the Tooling.

To buy new Tooling from LFA, simply go to <https://www.lfacapsulefillers.com/fac-range-plates-moulds-set>

To watch a video of an FACP® Range Tooling change, go to <https://www.lfacapsulefillers.com/videos/fac-capsule-filler-tooling-change>

Tools and Materials Needed

- Set of metric Allen keys with ball ends
- Metric wrench set
- New Tooling
- Tooling Calibration Set from FACP® Range Toolkit
- Permanent marker
- Crosshead screwdriver
- Empty capsules suited for new Tooling
- Disposable latex/rubber gloves (for food grade products and to protect hands from grease)
- Hairnet and/or beard net (food grade products only)
- Sterile shoe covers (food grade products only)



WARNING: To prevent any potential personal injury, ALWAYS unplug the FACP® from the electrical outlet when replacing parts.

Instructions

Note: Wear latex/rubber gloves (and appropriate food grade attire if applicable) during this process.

Part One: Changing the Capsule Die Segments

1. Open the Perspex Casing's doors.
2. Remove the two bolts and small metal plate at the top of the Capsule Closing Plate with a wrench.

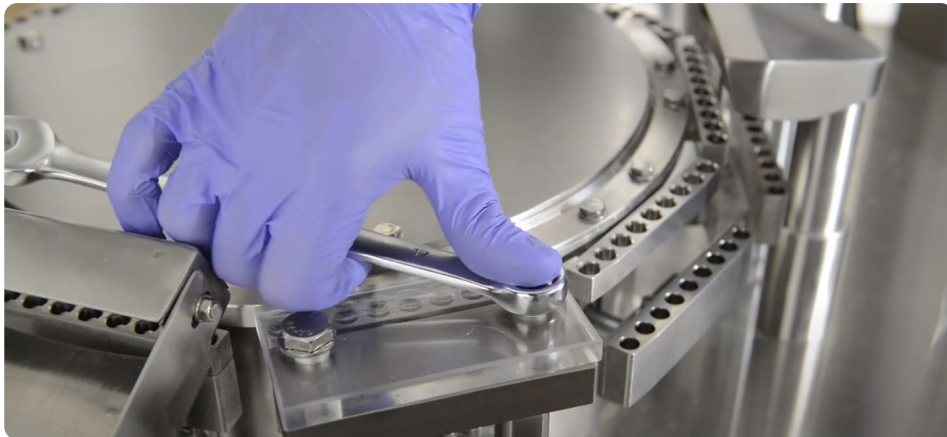

3. Remove the top section of the Tooling's two bolts with a wrench.

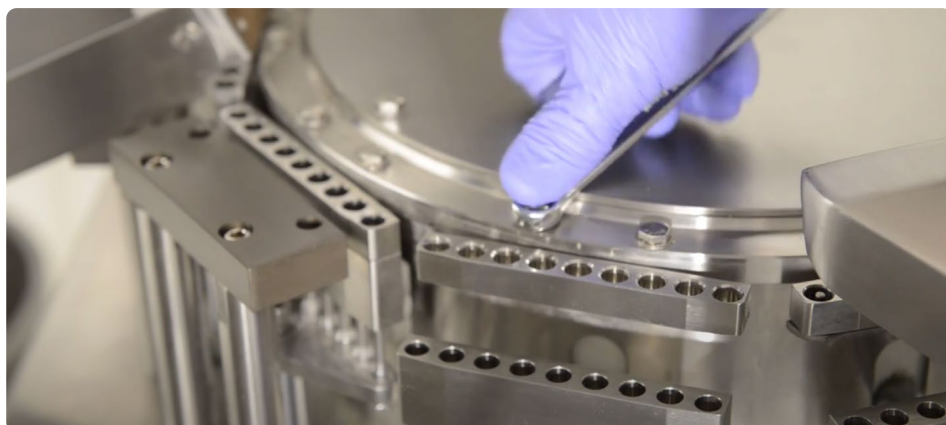

4. Take off the top section of the Tooling and set aside.

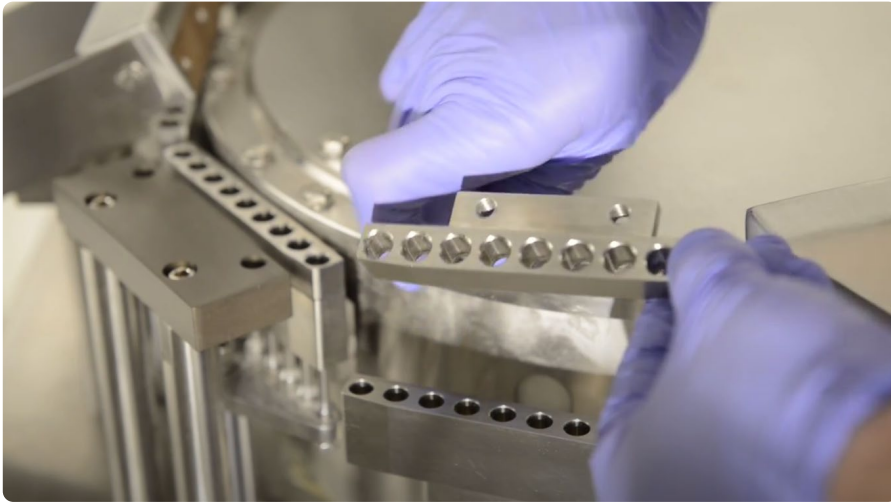

5. Remove the bolt behind the bottom section of the Tooling with an Allen key.



6. Take off the bottom section of the Tooling and set aside.

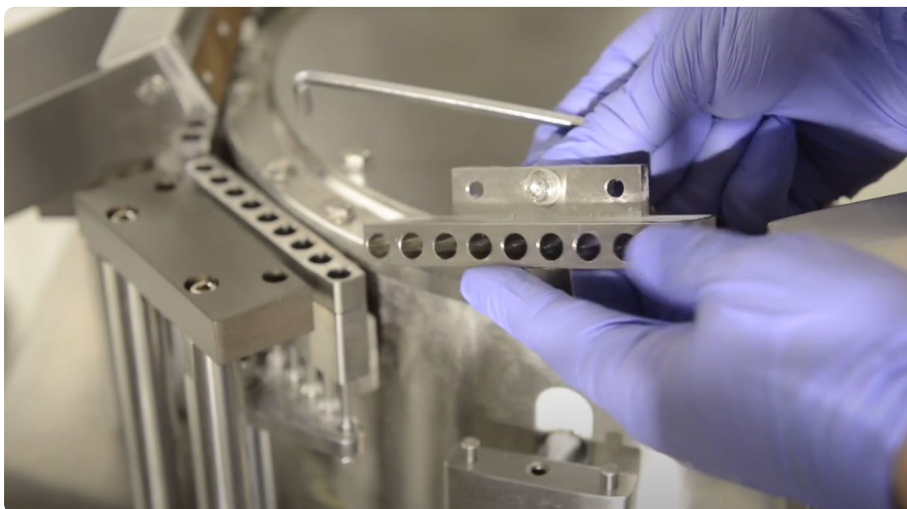

7. Manually operate machine until the next set of the Tooling sections are accessible.

8. Repeat steps 2-7 until all Tooling sections are removed.

9. Insert one of the new bottom sections of Tooling onto the Turret and tighten its bolt with an Allen key.



10. Place one of the new top sections of the Tooling under the lip of the Turret chamfer side up and loosely tighten its bolts by hand.

10.1 Note: The bolts should be finger tight so that the new top section can still move.



11. Rotate the machine so that the new Tooling is at the next station.

12. Insert the alignment tools from the Tooling Calibration Set into the two end slots of the Tooling.



13. Tighten the new top section of the Tooling with a wrench with the alignment tools still in place.

13.1 Note: Tighten the bolts slowly and in small increments. While tightening, occasionally lift the Alignment Tools and rotate them inside the new Tooling to ensure they are in the correct position.

14. Repeat steps 9-13 until all of the new Tooling sections are installed.
15. Place the metal plate and Capsule Closing Plate back onto the Turret.
 - 15.1 Note: Ensure that the chamfered edge is facing down and the Capsule Closing Plate is covering the Tooling.



16. Tighten the Capsule Closing Plate's bolts finger tight first, then equally tight with a wrench.



Part Two: Capsule Sewing Section

17. Turn the Capsule Hopper door's knob counterclockwise to loosen it.
 - 17.1 Note: The door will fall down and prevent capsules from falling out.



18. Remove the Capsule Hopper by loosening its two bolts with an Allen key.

18.1 Note: Remove the Capsule Hopper carefully to not damage the Capsule Magazine edge.

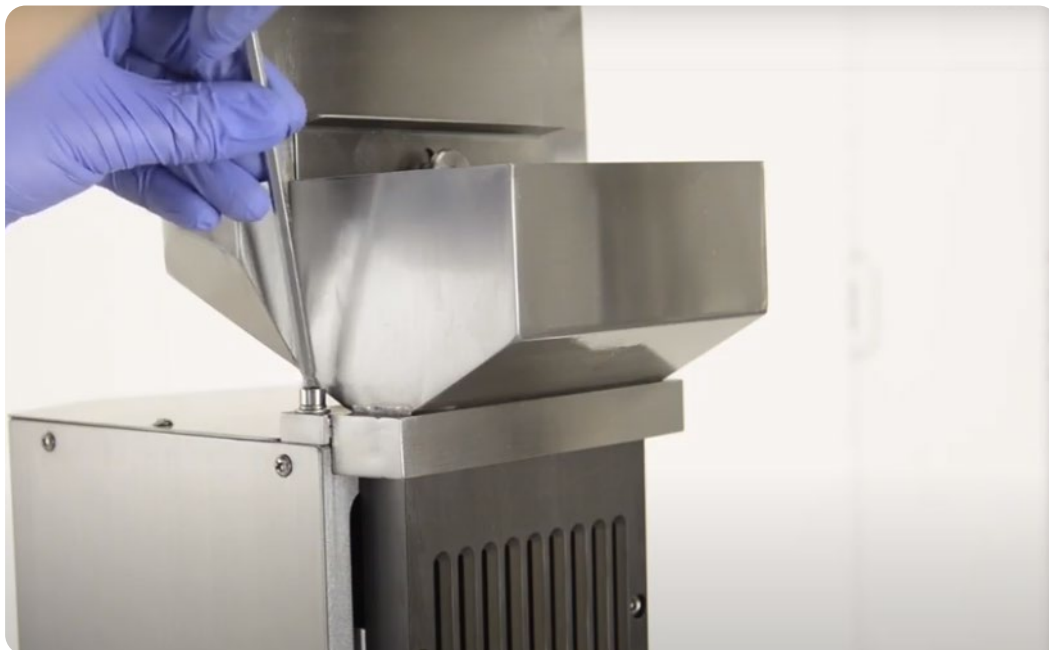

19. Remove the front section of the Capsule Magazine with an Allen key.

19.1 Note: Keep a hold of the front section to ensure it does not fall.

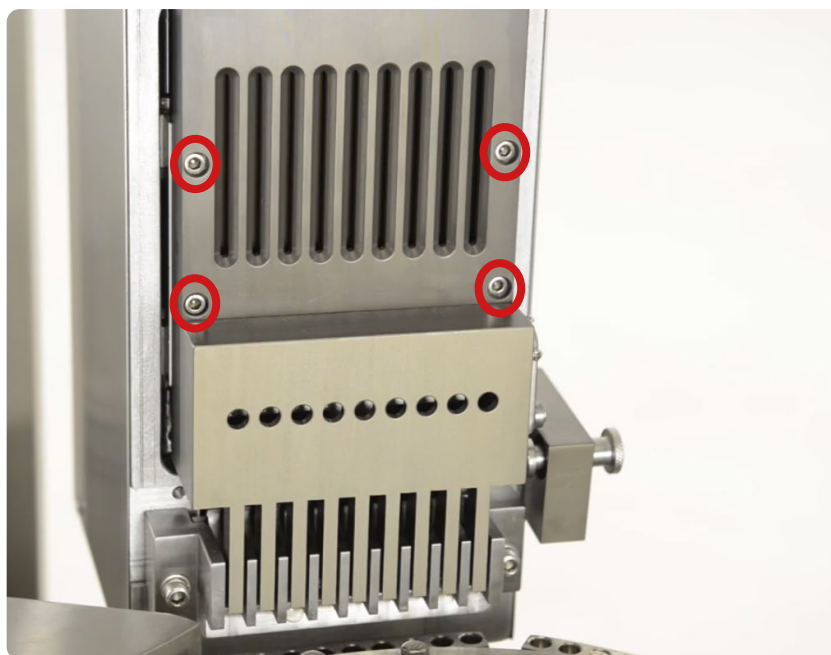

20. Remove the Capsule Magazine's teeth with an Allen key.



21. Trace the washers on the mounting block with a permanent marker.

21.1 Note: This is to mark their position so the mounting block can be attached correctly.



22. Remove the mounting block with an Allen key.

23. Remove the screws on either side of the Capsule Sewing Station with a crosshead screwdriver and remove the panel.

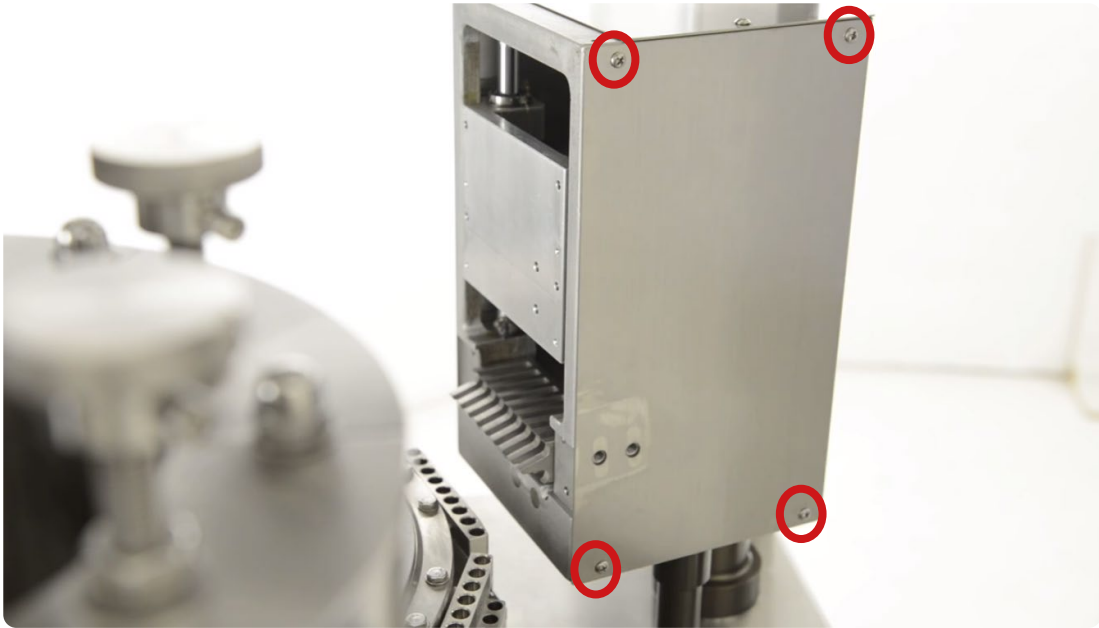

24. Remove the Capsule Magazine's back teeth with an Allen key.

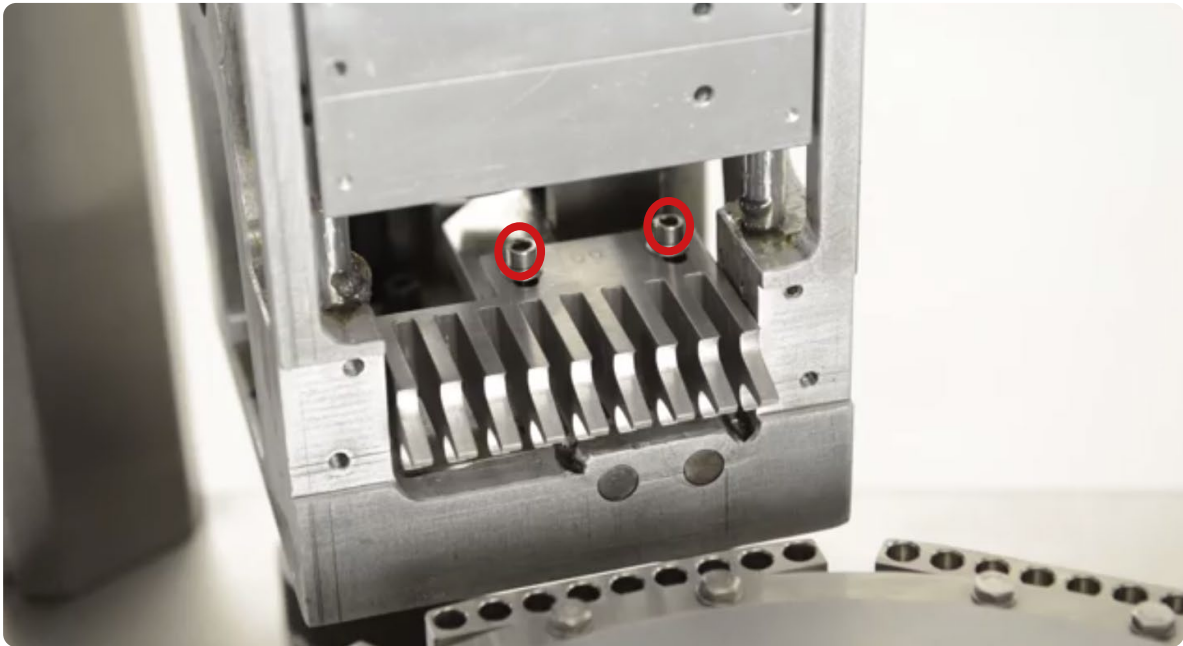

25. Insert the new back teeth onto the Capsule Magazine and tighten its bolts with an Allen key.
25.1 Note: The bolts should be finger tight so that the new back teeth can still move.

26. Insert the new front teeth into the new back teeth and tighten its side bolts with an Allen key.
26.1 Note: The bolts should be finger tight so that the new front teeth can still move.



27. Insert the alignment tools from the Tooling Calibration Set in the two ends of the new front and back teeth.

27.1 Note: Ensure that the thicker end of the alignment tools goes into capsule bores first.

28. Adjust the new front and back teeth according to the alignment tools.



29. Tighten the new front teeth's bolts in equal increments with an Allen key.

29.1 Note: The alignment tools should still be in place while tightening to ensure correct adjustment.

30. Remove the alignment tools from the new front and back teeth.

31. Manually operate the machine so that the new back teeth move the furthest forward in their cycle.

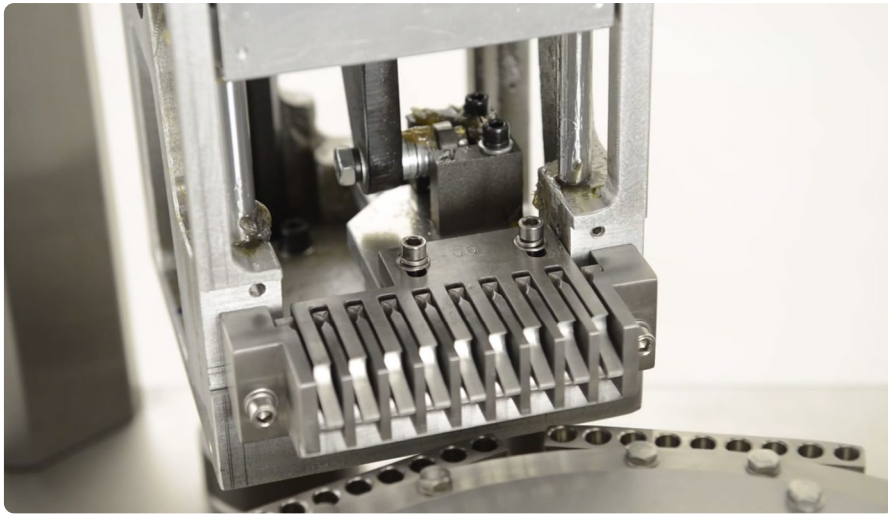

32. Insert two empty capsules cap first into the two end slots of the new front and back teeth.

32.1 Note: Ensure that the capsule cap ends are aligned with the new front teeth and that the new front and back teeth are not touching each other.

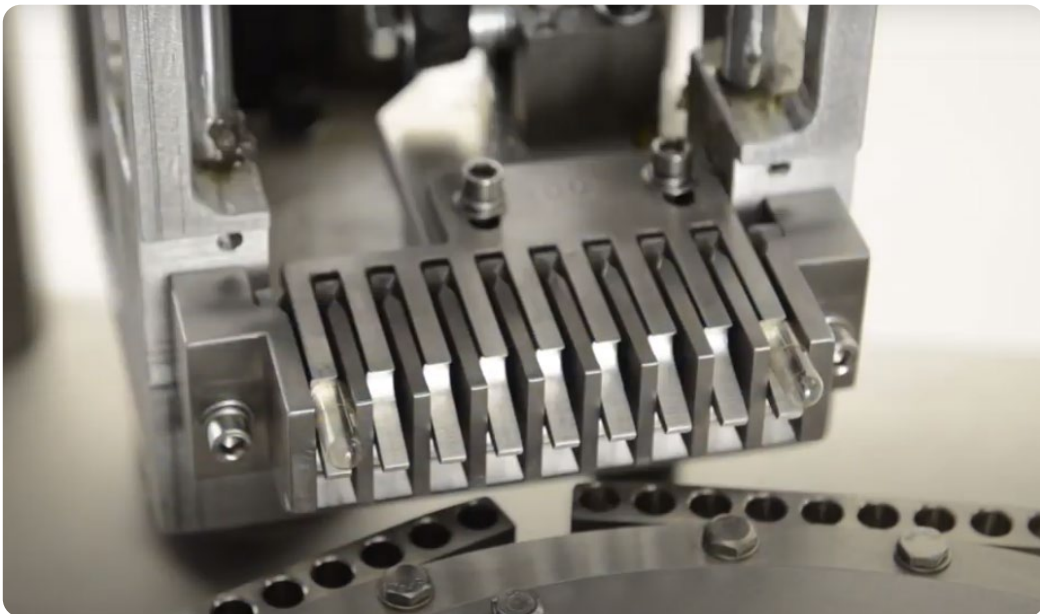

33. Tighten the new back teeth's bolts with an Allen key in equal and small increments.

33.1 Note: Ensure that the capsules are still aligned while tightening.

34. Manually operate the machine for one rotation.

34.1 Note: If any squeaking or metal-on-metal contact occurs, readjust the new front and back teeth.

35. Insert the new front section of the Capsule Magazine into the new front and back teeth.
36. Loosely tighten the new front section's four bolts to the Capsule Magazine with an Allen key.



37. Manually operate the machine until the new front section of the Capsule Magazine drops down to its lowest position.



38. Ensure that the gaps between the new front section and the new front and back teeth have sufficient space and are not causing any metal-on-metal contact.
39. Fully tighten the new front section's four bolts to the Capsule Magazine.
40. Manually operate the machine one more time to ensure that there is no metal-on-metal contact.

41. Insert the side panels back onto the Capsule Sewing Station and tighten their screws with a crosshead screwdriver.
42. Insert empty capsules into the top of the new front section of the Capsule Magazine.

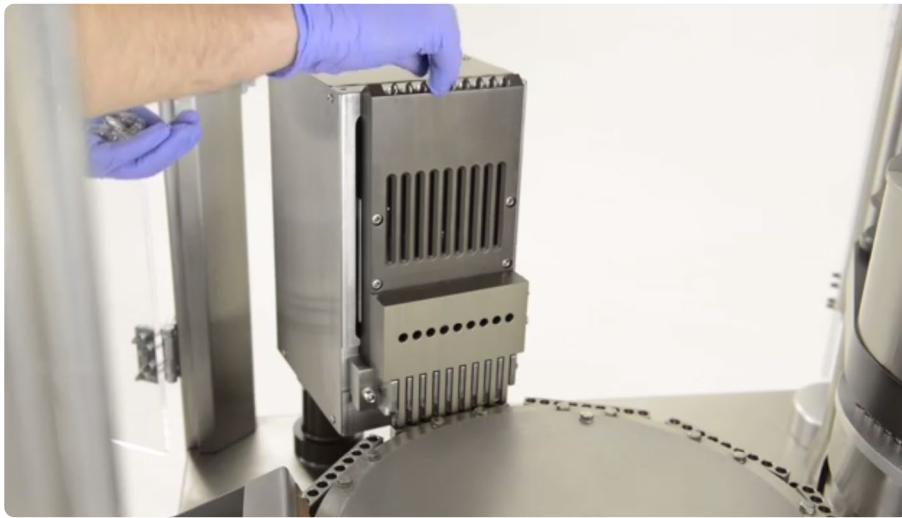

43. Manually rotate the machine so that the new front section of the Capsule Magazine is at its highest point.

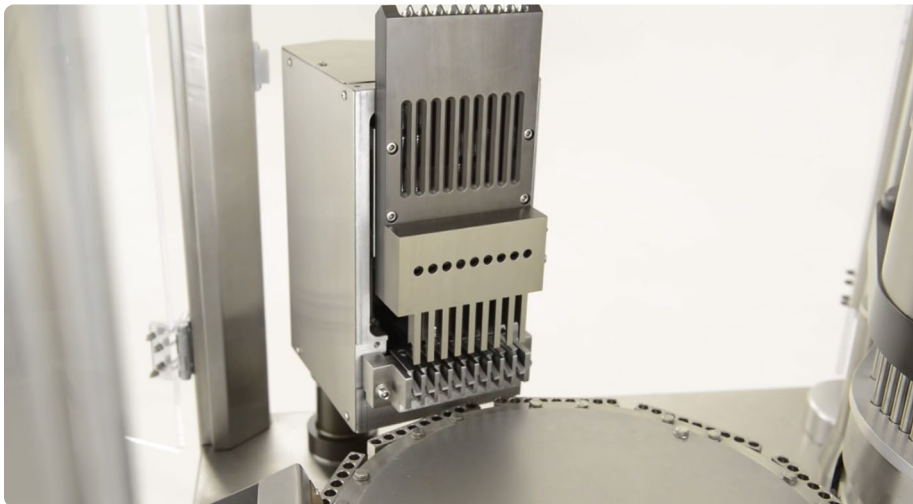

44. Reinstall the mounting block on the side of the Capsule Magazine with an Allen key.
44.1 Note: Use the markings made earlier to ensure that it is in the correct position.



45. Press in the capsule release pin.

45.1 Note: Check that the gate is positioned correctly and release the capsules before moving on to the next step.



46. Lower the Capsule Hopper onto the new Capsule Magazine.

46.1 Note: Lower the Capsule Hopper carefully and gently to avoid damaging the Capsule Magazine.



47. Tighten the Capsule Hopper's bolts with an Allen key.



48. Manually rotate the machine one more time to ensure there is no metal-on-metal scraping.

Part Three: Changing the Tamping Turret

49. Loosen the bolt on the pillar that holds the Powder Hopper and Powder Auger with a wrench.

50. Raise the pillar that holds the Powder Hopper and Powder Auger and re-tighten the bolt with a wrench.



51. Loosen the three bolts underneath the top section with an Allen key.



52. Loosen the bolt with an Allen key and lower the Powder Hopper.

52.1 Note: More than one person should be involved in this step to prevent the Powder Hopper from falling.



53. Remove the bolts on the top section's panel with an Allen key and remove it.



54. Remove the Auger Paddle's bolt with an Allen key and carefully lower the Powder Hopper.

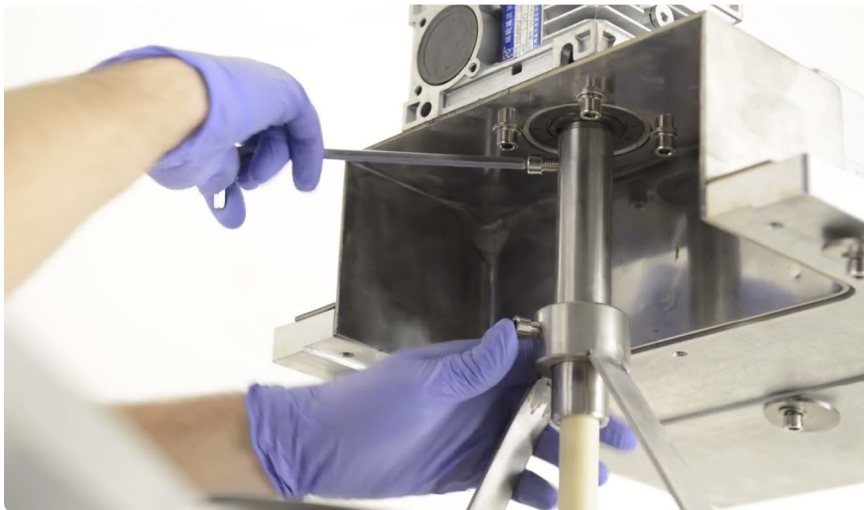

55. Rotate the top section away and remove the Powder Hopper.

55.1 Note: More than one person should be involved in this step to prevent the Powder Hopper from falling.



56. Pull out the sensor from the inside of the Tamping Turret.



57. Mark the following numbers on the stations:



58. Remove the nuts and washers from the top of the Tamping Turret with a wrench.



59. Carefully pull up each station to remove the Tooling.

59.1 Note: Ensure not to damage the fragile ends of the Tamping Pins.



60. Lift up the extra panel, the inner metal casing, and outer metal casing and set aside.

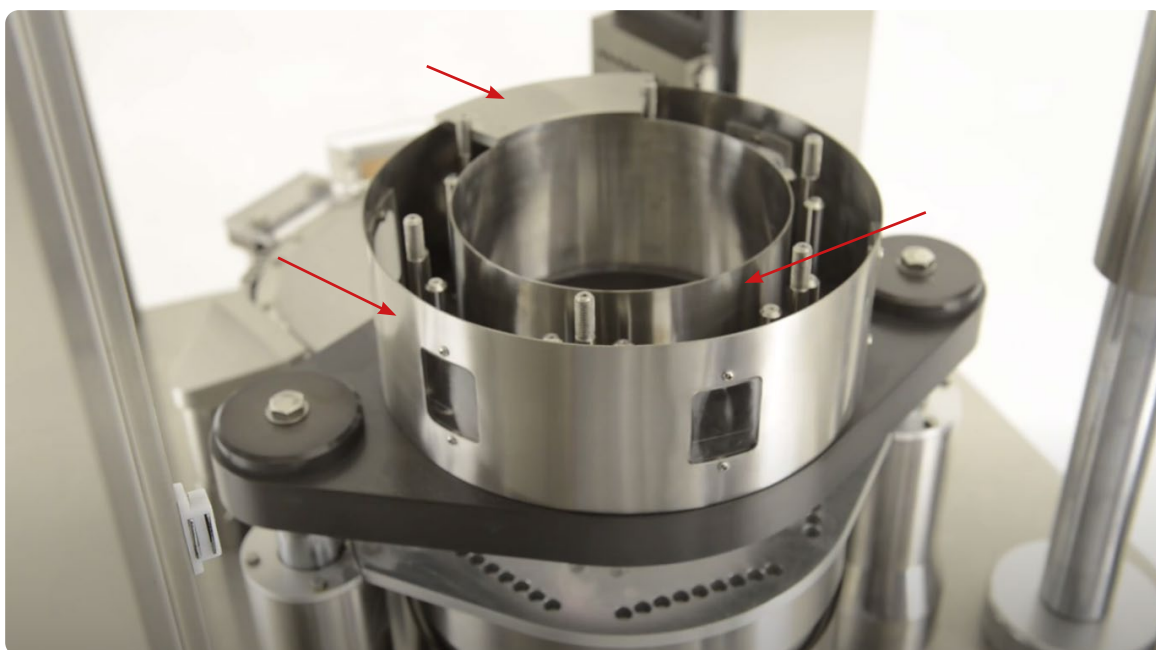

61. Remove the bolt with a wrench and carefully lift up the block.
61.1 Note: Ensure not to lose the brass spacer.



62. Remove both bolts from the sides and lift up the middle section of the Tamping Turret.

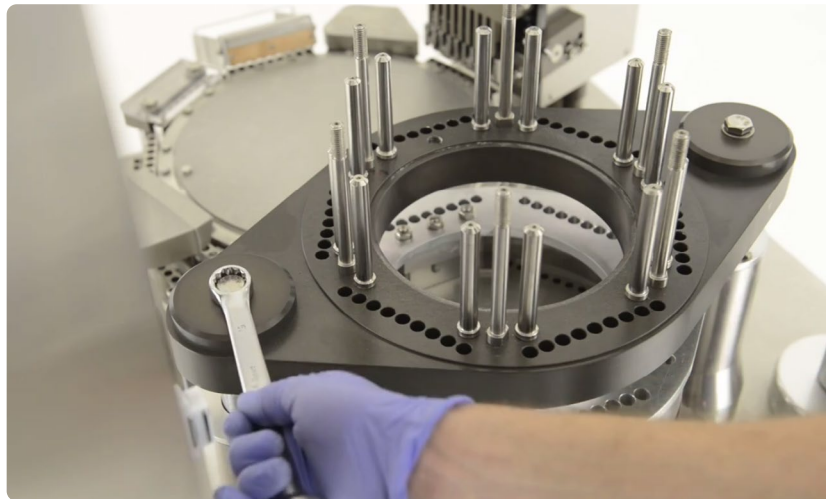

63. Remove the four bolts from the Tamping Pins Guide Runner with a wrench and lift it up.



64. Remove the bottom three bolts of the Tamping Bowl with the special tool included in the Toolkit.



65. Lift up and remove the bottom of the Tamping Turret.

66. Clean the bottom area of excess powder and inspect the brass ring for wear.

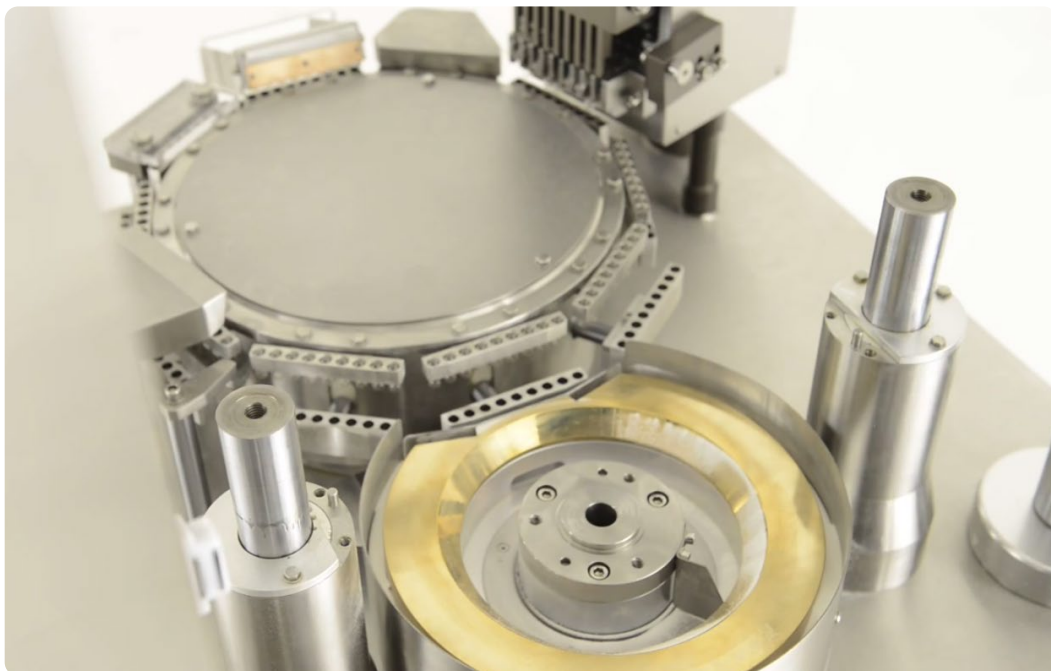

Note: If the brass ring has wear, refinish on a flat surface it with 1000 to 3000 grit sandpaper.

67. Place the new bottom of the Tamping Bowl onto the machine and loosely tighten the bolts.



68. Insert the new Tamping Pins Guide Runner onto the new bottom plate.

68.1 Note: Ensure that the sensor holder is facing outwards.



69. Fully tighten the four bolts onto the new Dosing Plate of the Tamping Turret.

69.1 Note: Ensure to tighten in small and equal increments.

70. Insert the new middle section of the Tamping Turret onto the new middle plate.

70.1 Note: Ensure that the hole of the brass spacer is facing the main Turret.

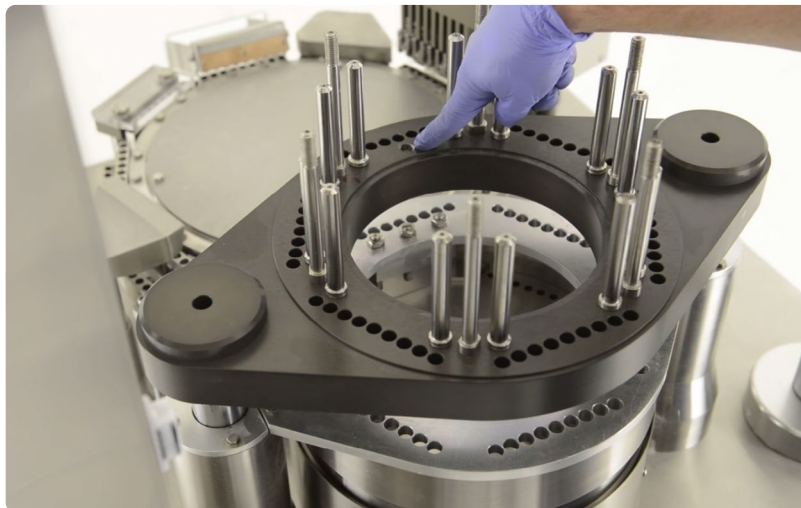

71. Fully tighten the two bolts on the new middle section of the Tamping Turret.

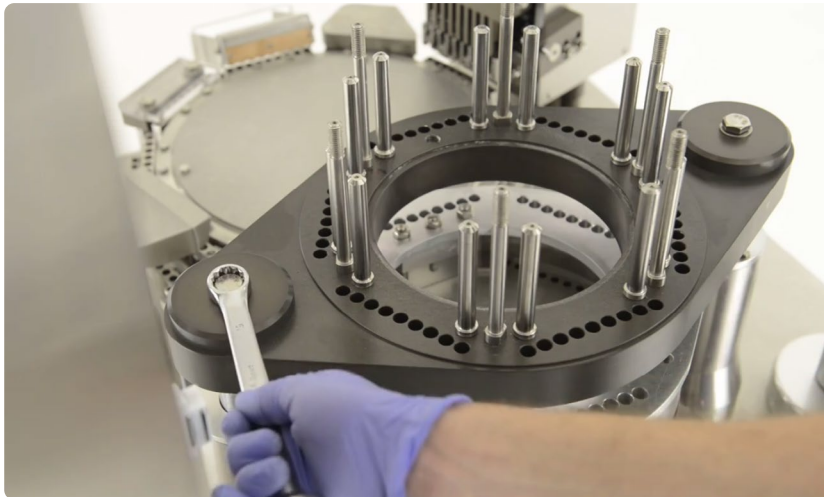

72. Manually rotate the machine until the Tamping Turret is at its lowest point.

73. Insert the alignment tools from the Tooling Calibration Set into the two ends of the Tamping Turret's new middle section and new Dosing Plate.



74. Adjust the new bottom of the Tamping Turret so that the alignment tools easily fall in the holes and are able to move freely.

75. Fully tighten the three bolts on the Tamping Bowl with the special tool included with the Toolkit.

75.1 Note: Ensure to tighten the bolts equally and in small increments.

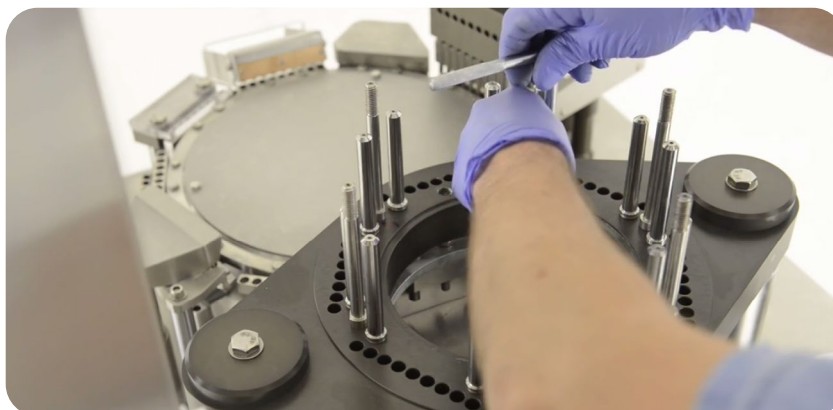

76. Check the alignment tools while tightening the new bottom of the Tamping Turret and make adjustments as necessary.

77. Remove the alignment tools.

78. Insert the capsule slug block into the Tamping Turret and place the brass spacer.

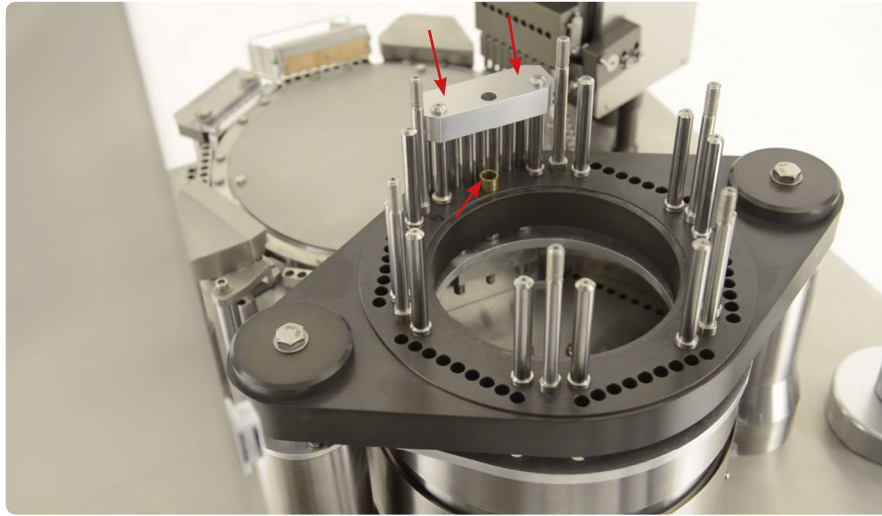

79. Push down on the block until it meets the brass spacer.

80. Tighten the block's bolt with a wrench.

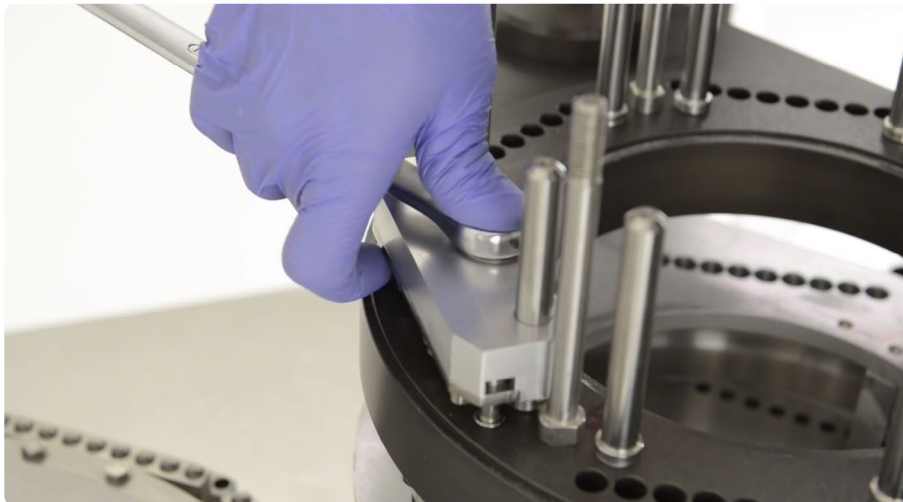

81. Insert the new inner metal casing and outer metal casing onto the Tamping Turret.

81.1 Note: The inner metal casing fits into a groove on the Tamping Turret. Ensure that the windows on the outer metal casing are each facing a station with the windowless area facing the main Turret.

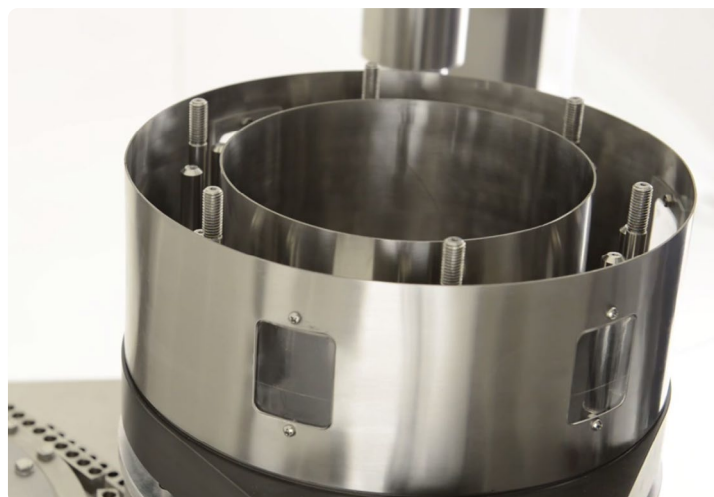

82. Insert each of the Tamping Pins into their appropriate stations in the Tamping Turret.
82.1: Ensure not to damage the fragile ends.

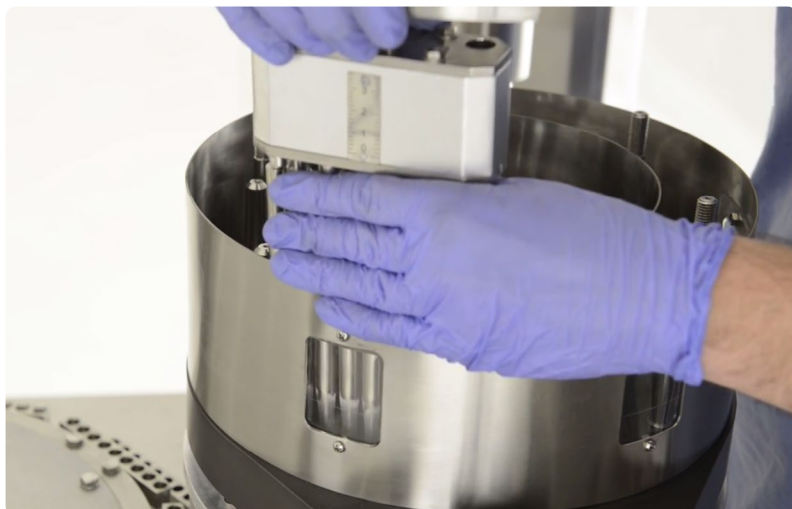

83. Tighten each of the bolts on top of the Tamping Turret with a wrench.
83.1 Note: Ensure to tighten the bolts equally and in small increments.



84. Insert the sensor through the middle of the Tamping Turret and into its retainer.
85. Reinsert the Powder Hopper gently.
86. Rotate the top section back over the Powder Hopper.
87. Reconnect the Auger Paddle with an Allen key.

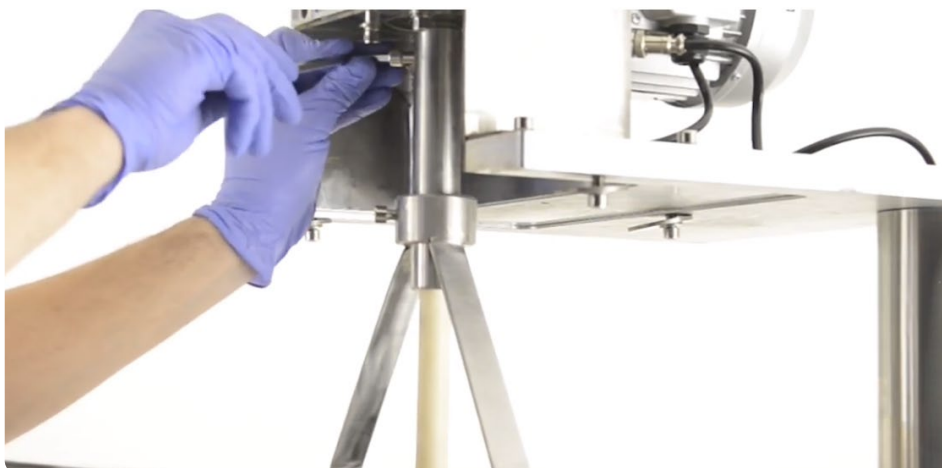

88. Raise the Powder Hopper into position and tighten its bolts with an Allen key.



89. Place the top section panel back and secure its bolts with an Allen key.



90. Loosen the top section's pillar with a wrench and lower it.

91. Tighten the top section's pillar once it is in the lowered position.



Note: Sometimes while switching to a smaller Tooling set, the sealing assembly locking rod can become crooked, which affects the sealing section working properly. If the sealing assembly locking rod is not straight, remove one or both of the thinner washers until it is straightened.

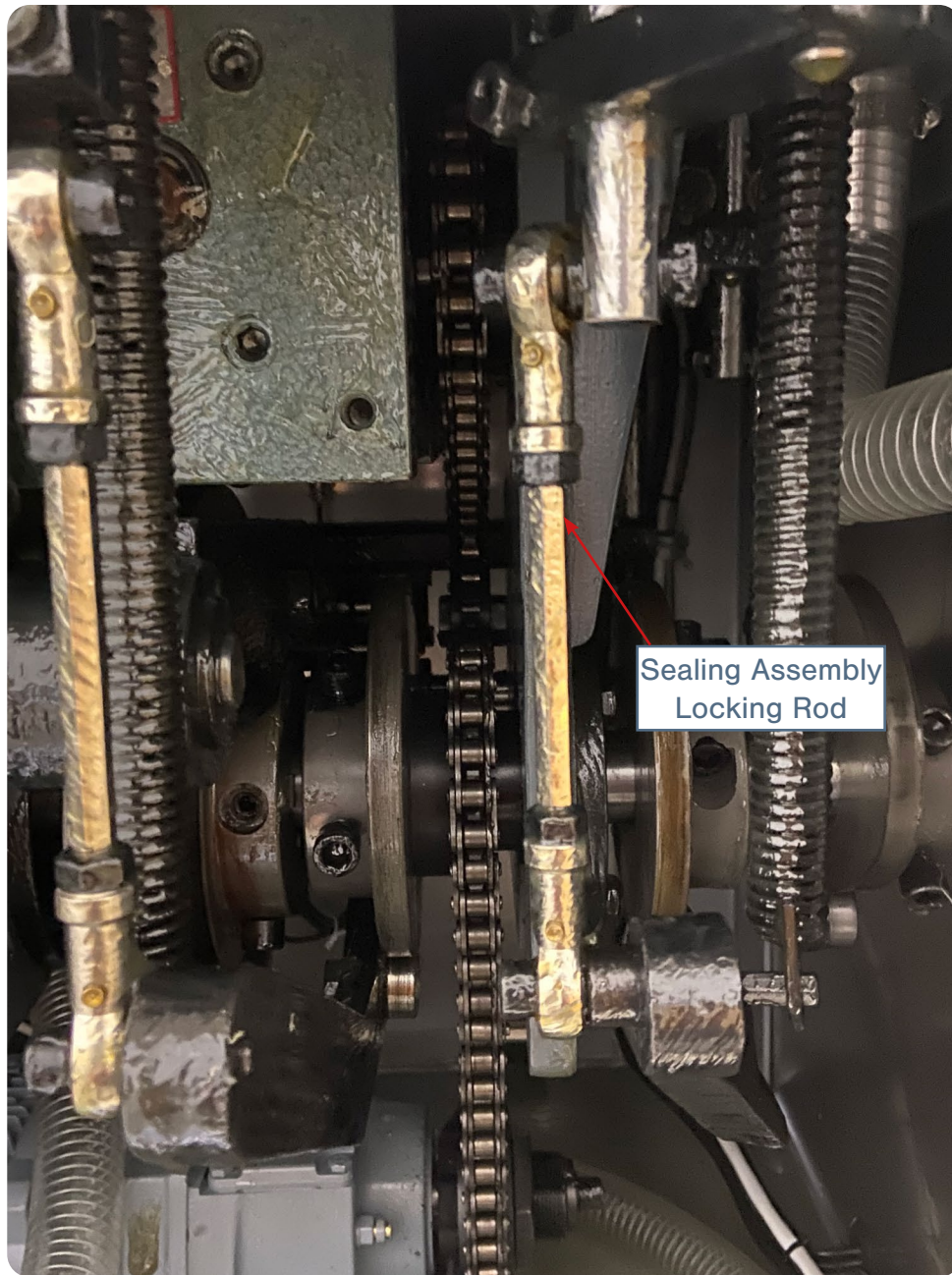

Capsule Holding Pins

The Capsule Holding Pins hold the capsules in the Capsule Magazine and time their release. They can become damaged in the event of a jam, during cleaning, or if mishandled.

Tools and Materials Needed

- Crosshead screwdriver
- Set of metric Allen keys with ball ends
- New Capsule Holding Pins
- Disposable latex/rubber gloves (for food grade products and to protect hands from grease)
- Hairnet and/or beard net (food grade products only)
- Sterile shoe covers (food grade products only)



WARNING: To prevent any potential personal injury, ALWAYS unplug the FACF® from the electrical outlet when replacing parts.

Instructions

Note: Wear latex/rubber gloves (and appropriate food grade attire if applicable) during this process.

Remove the Capsule Hopper Pins

1. Turn the Capsule Hopper door's knob counterclockwise to loosen it.
 - 1.1 Note: The door will fall down and prevent capsules from falling out.



2. Remove the Capsule Hopper by loosening its two bolts with an Allen key.
 - 2.1 Note: Remove the Capsule Hopper carefully to not damage the Capsule Magazine edge.

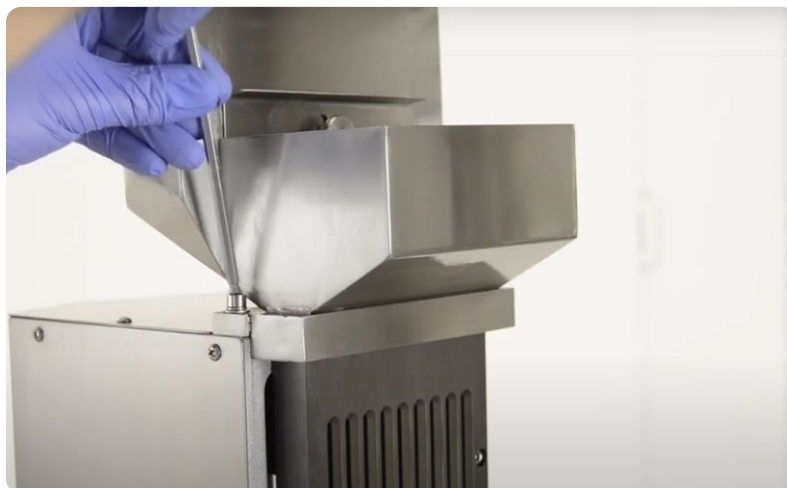

3. Remove the front section of the Capsule Magazine with an Allen key.
 - 3.1 Note: Keep a hold of the front section to ensure it does not fall.

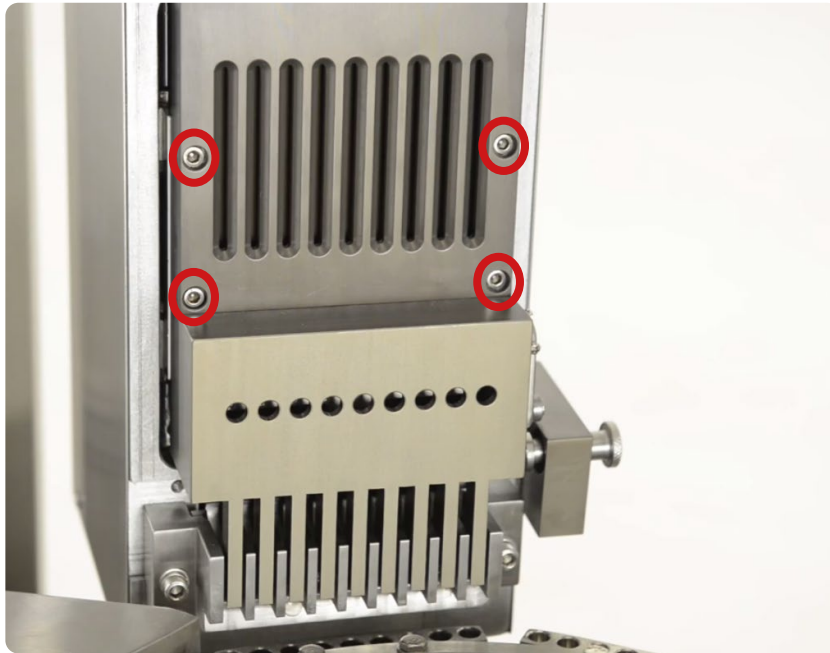

4. Remove the screws on the Capsule Magazine's back with a crosshead screwdriver.

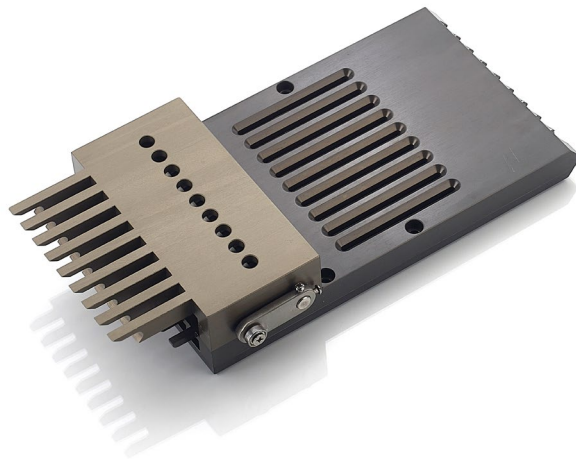

5. Remove each of the screws holding the Capsule Holding Pins with a crosshead screwdriver.

Remove the Capsule Holding Pins

6. Insert the new Capsule Holding Pins into place.
 - 6.1 Note: Ensure that all of the new Capsule Holding Pins are aligned.
7. Secure the new Capsule Holding Pins onto the Capsule Magazine with a crosshead screwdriver.
8. Tighten the side of the Capsule Magazine's screws with a crosshead screwdriver
9. Secure the front section of the Capsule Magazine's screws with an Allen key.
10. Reinsert the Capsule Hopper and tighten its two bolts with an Allen key.

Dosing Disk Wear Ring

As the Dosing Disk rotates to create the powder slugs, it turns over the Dosing Disk Wear Ring. This part not only helps facilitates the Tamping Station's movement, but also gives a flat surface for the powder slugs to be formed against.

Tools and Materials Needed

- Set of metric Allen keys with ball ends
- Metric wrench set
- New Dosing Disk Wear Ring
- Tooling Calibration Set from FACF® Range Toolkit
- Permanent marker
- Crosshead screwdriver
- Disposable latex/rubber gloves (for food grade products and to protect hands from grease)
- Hairnet and/or beard net (food grade products only)
- Sterile shoe covers (food grade products only)



WARNING: To prevent any potential personal injury, ALWAYS unplug the FACF® from the electrical outlet when replacing parts.

Instructions

Note: Wear latex/rubber gloves (and appropriate food grade attire if applicable) during this process.

Remove the Dosing Disk Wear Ring

1. Loosen the bolt on the pillar that holds the Powder Hopper and Powder Auger with a wrench.
2. Raise the pillar that holds the Powder Hopper and Powder Auger and re-tighten the bolt with a wrench.



3. Loosen the three bolts underneath the top section with an Allen key.



4. Loosen the bolt with an Allen key and lower the Powder Hopper.

4.1 Note: More than one person should be involved in this step to prevent the Powder Hopper from falling.



5. Remove the bolts on the top section's panel with an Allen key and remove it.



6. Remove the Auger Paddle's bolt with an Allen key and carefully lower the Powder Hopper.

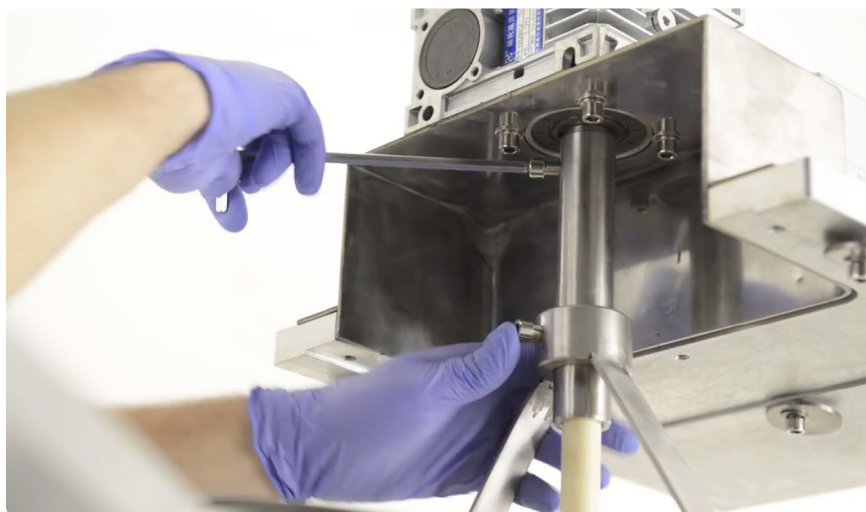

7. Rotate the top section away and remove the Powder Hopper.

7.1 Note: More than one person should be involved in this step to prevent the Powder Hopper from falling.



8. Pull out the sensor from the inside of the Tamping Turret.



9. Mark the following numbers on the stations:



10. Remove the nuts and washers from the top of the Tamping Turret.



11. Carefully pull up each station to remove the Tooling.

11.1 Note: Ensure not to damage the fragile ends of the Tamping Pins.



12. Lift up the extra panel, the inner metal casing, and outer metal casing and set aside.

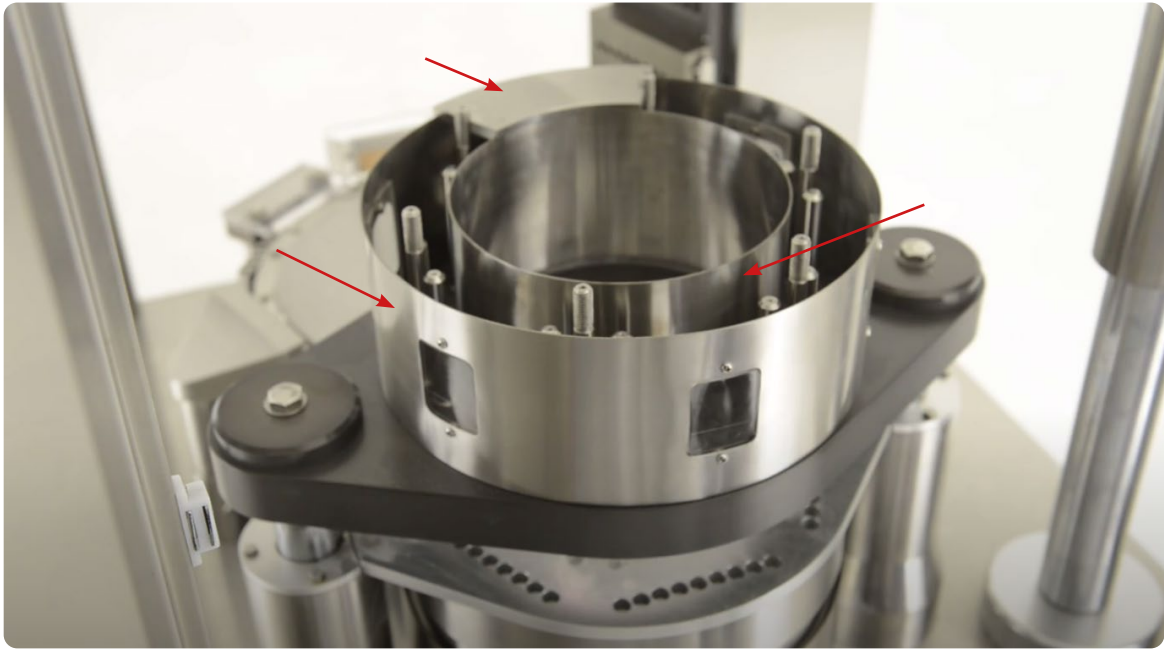

13. Remove the bolt with a wrench and carefully lift up the block.

13.1 Note: Ensure to not lose the brass spacer.



14. Remove both bolts from the sides and lift up the middle section of the Tamping Turret.

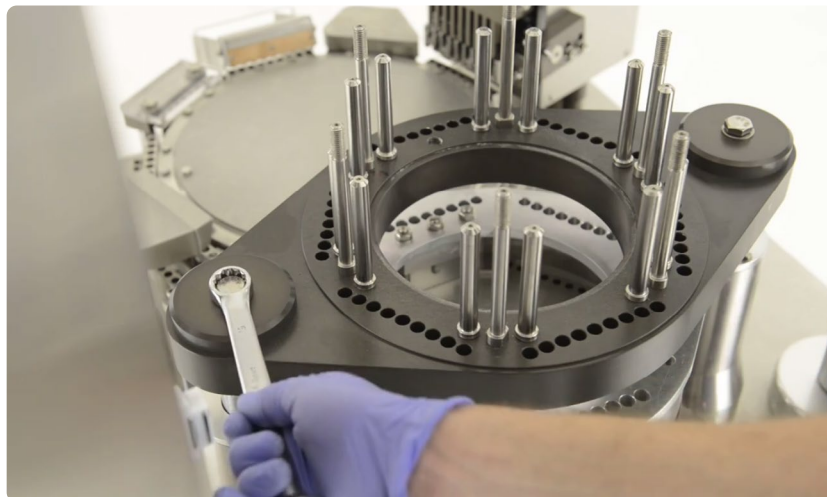

15. Remove the four bolts from the Dosing Disk with a wrench and lift it up.



16. Remove the bottom three bolts of the Tamping Bowl with the special tool included in the Toolkit.



17. Lift up and remove the bottom of the Tamping Turret.
18. Remove the brass Dosing Disk Wear Ring from the machine.



Replace the Dosing Disk Wear Ring

19. Insert the new Dosing Disk Wear Ring onto the bottom of the Tamping Turret.
20. Reinsert the bottom of the Tamping Turret and resecure its three bolts with the special tool included in the Toolkit.
21. Reattach the Dosing Disk by screwing in its four bolts with a wrench.
22. Reattach the middle section of the Tamping Turret by screwing in its two bolts with a wrench.
23. Reinsert the block and reattach its bolt with a wrench.
24. Reinsert the inner metal casing, the outer metal casing, and extra panel.
25. Insert each of the Tamping Pins into their appropriate stations in the Tamping Turret.
 - 25.1: Ensure not to damage the fragile ends.

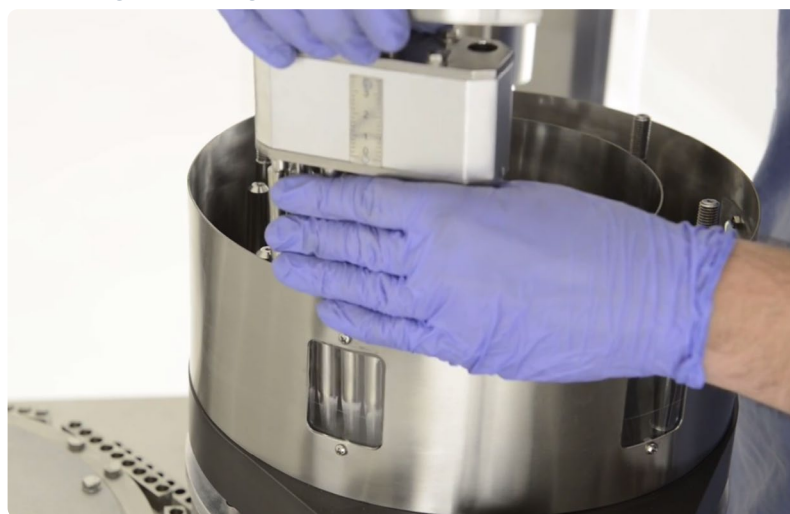

26. Tighten each of the bolts on top of the Tamping Turret with a wrench.
26.1 Note: Ensure to tighten the bolts equally and in small increments.



27. Insert the sensor through the middle of the Tamping Turret and into its slotted area.
28. Reinsert the Powder Hopper gently.
29. Rotate the top section back over the Powder Hopper.
30. Reconnect the Auger Paddle with an Allen key.

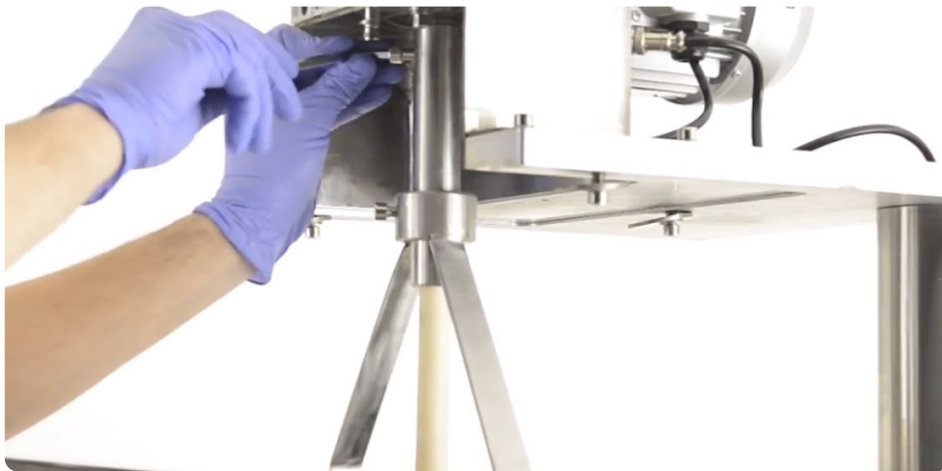

31. Raise the Powder Hopper into position and tighten its bolts with an Allen key.



32. Place the top section panel back and secure its bolts with an Allen key.



33. Loosen the top section's pillar with a wrench and lower it.

34. Tighten the top section's pillar once it is in the lowered position.



Brass Spacer

The Brass Spacer calibrates the set of Tamping Pins that are used to push the slugs into the capsule bodies. Although it is unlikely this part will be worn down or broken, it is very easy to lose during cleaning and/or maintenance.

Tools and Materials Needed

- Set of metric Allen keys with ball ends
- Metric wrench set
- New Dosing Disk Wear Ring
- Tooling Calibration Set from FACF® Range Toolkit
- Permanent marker
- Crosshead screwdriver
- Disposable latex/rubber gloves (for food grade products and to protect hands from grease)
- Hairnet and/or beard net (food grade products only)
- Sterile shoe covers (food grade products only)



WARNING: To prevent any potential personal injury, ALWAYS unplug the FACF® from the electrical outlet when replacing parts.

Instructions

Note: Wear latex/rubber gloves (and appropriate food grade attire if applicable) during this process.

Replace the Dosing Disk Wear Ring

1. Loosen the bolt on the pillar that holds the Powder Hopper and Powder Auger with a wrench.
2. Raise the pillar that holds the Powder Hopper and Powder Auger and re-tighten the bolt with a wrench.



3. Loosen the three bolts underneath the top section with an Allen key.



4. Loosen the bolt with an Allen key and lower the Powder Hopper.

4.1 Note: More than one person should be involved in this step to prevent the Powder Hopper from falling.



5. Remove the bolts on the top section's panel with an Allen key and remove it.



6. Remove the Auger Paddle's bolt with an Allen key and carefully lower the Powder Hopper.

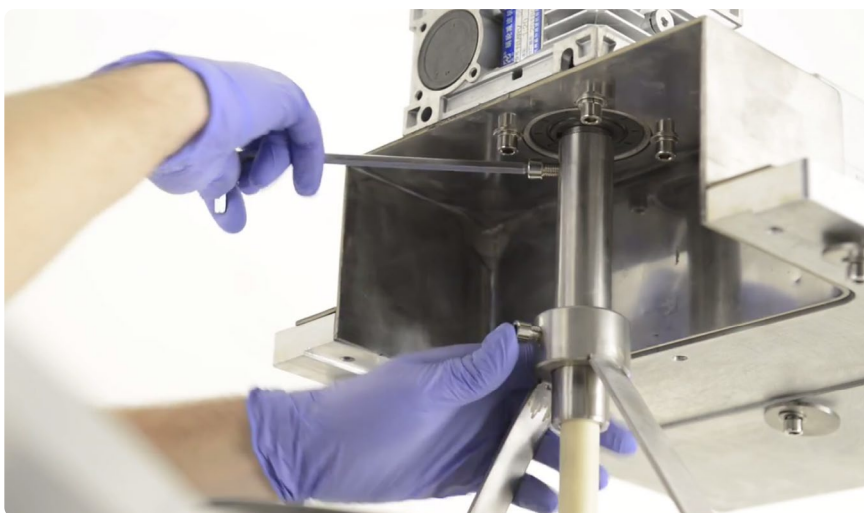

7. Rotate the top section away and remove the Powder Hopper.

7.1 Note: More than one person should be involved in this step to prevent the Powder Hopper from falling.



8. Pull out the sensor from the inside of the Tamping Turret.



9. Mark the following numbers on the stations:

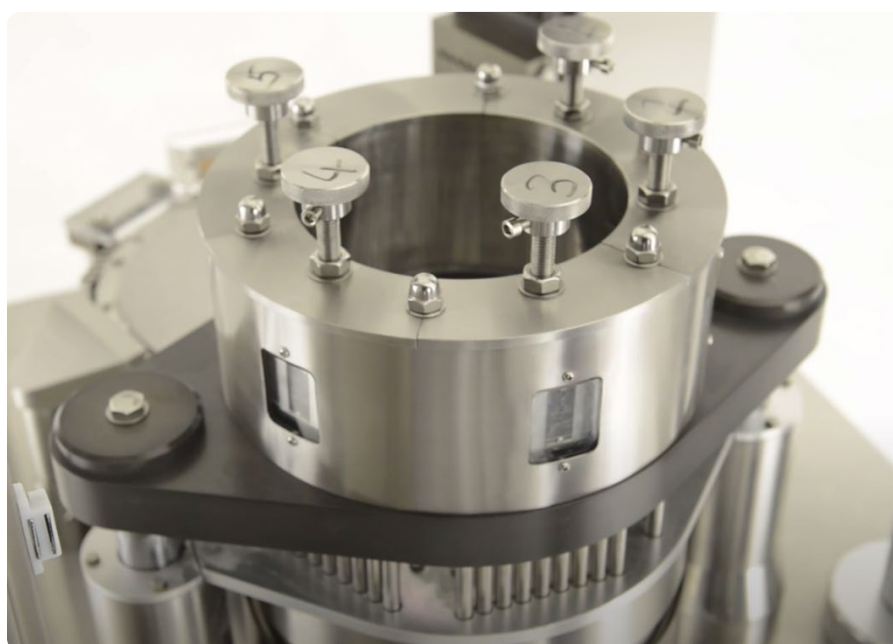

10. Remove the nuts and washers from the top of the Tamping Turret.



11. Carefully pull up all stations.

11.1 Note: Ensure not to damage the fragile ends of the Tamping Pins.



12. Lift up the extra panel, the inner metal casing, and outer metal casing and set aside.

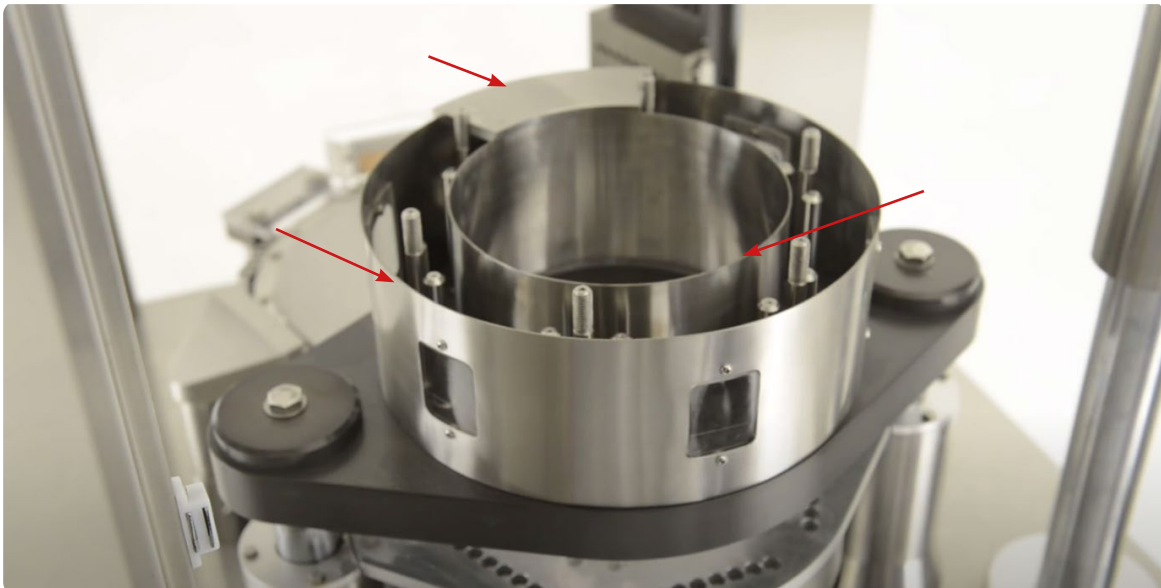

13. Loosen the block's bolt with a wrench.

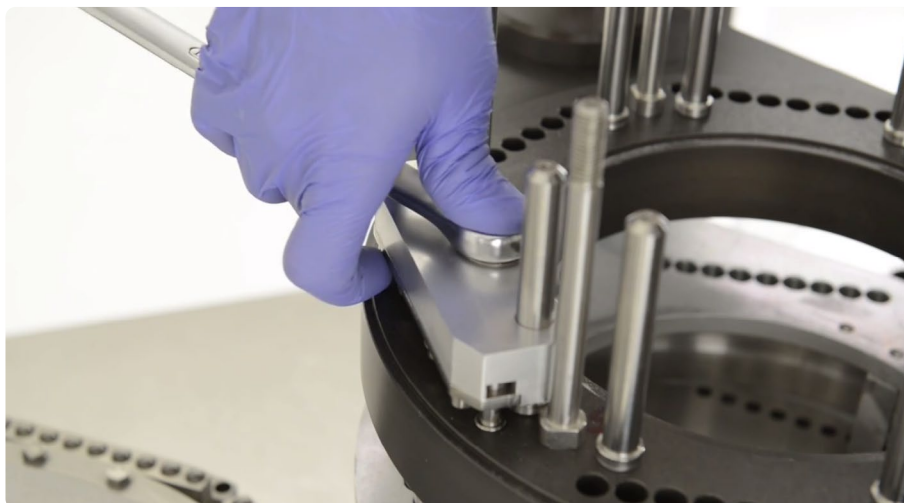

14. Raise the block to make room for the new Brass Spacer.

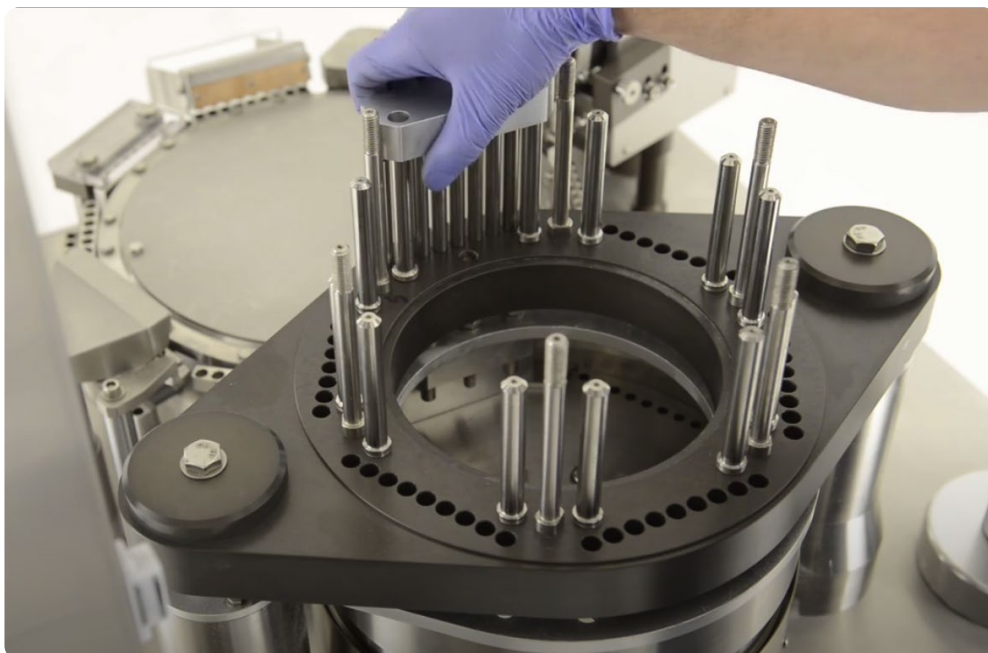

15. Place the new Brass Spacer on top of the bore.



- 16. Push down on the block until it meets the Brass Spacer.
- 17. Tighten the block's bolt with a wrench.

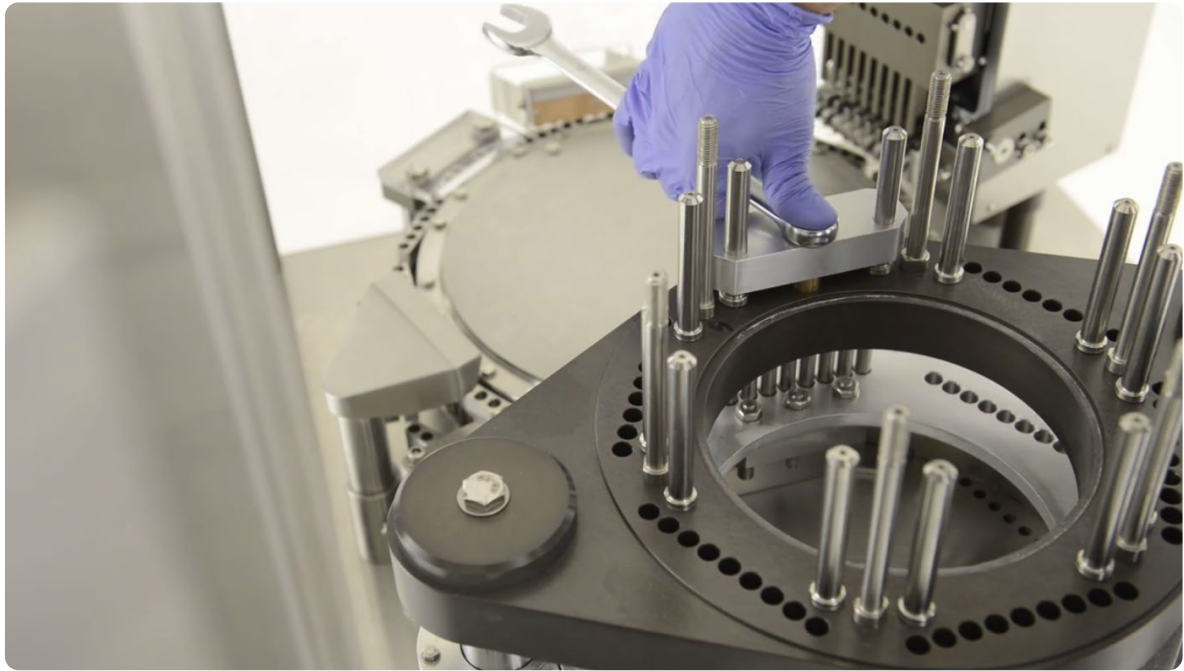

- 18. Reinsert the inner metal casing, the outer metal casing, and extra panel.
- 19. Insert each of the Tamping Pins into their appropriate stations in the Tamping Turret.
 - 19.1: Ensure not to damage the fragile ends.

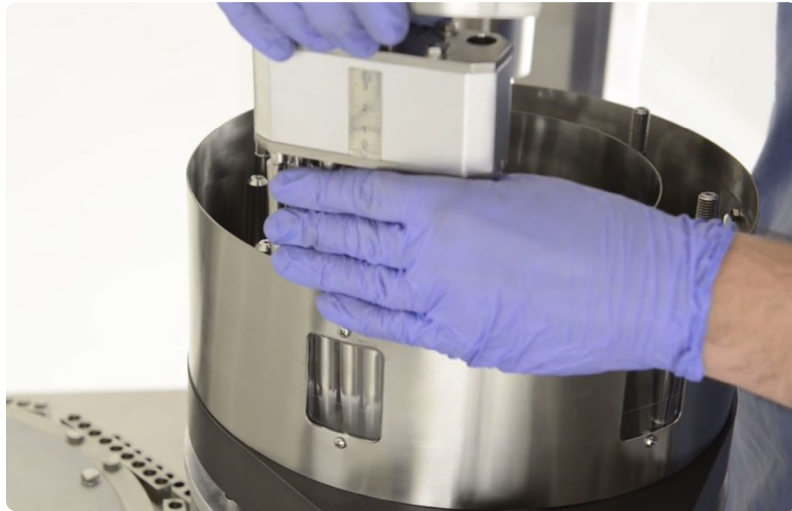

- 20. Tighten each of the bolts on top of the Tamping Turret with a wrench.
 - 20.1 Note: Ensure to tighten the bolts equally and in small increments.



21. Insert the sensor through the middle of the Tamping Turret and into its slotted area.
22. Reinsert the Powder Hopper gently.
23. Rotate the top section back over the Powder Hopper.
24. Reconnect the Auger Paddle with an Allen key.

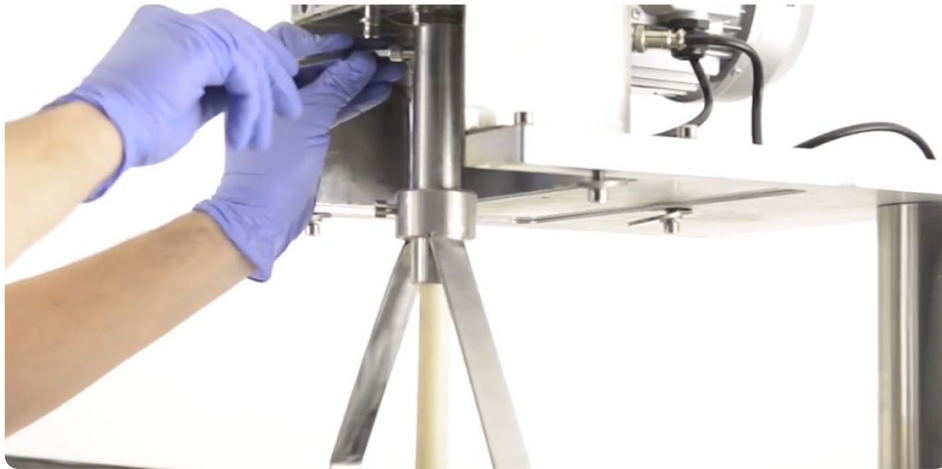

25. Raise the Powder Hopper into position and tighten its bolts with an Allen key.



26. Place the top section panel back and secure its bolts with an Allen key.



27. Loosen the top section's pillar with a wrench and lower it.
28. Tighten the top section's pillar once it is in the lowered position.

Troubleshooting

Sometimes unavoidable issues will occur while operating the FACF® range. Fortunately, there are several methods to remedy these issues.

Common Issues

Symptom	Possible Cause	Possible Solution
Blockage in Capsule Magazine	The capsules are too big or deformed.	Ensure that the capsules fit the Capsule Magazine.
	The Capsule Magazine is jammed.	Clean the Capsule Magazine tracks.
	Something is stuck in the Capsule Magazine's tracks.	Use sandpaper to polish the tracks and/or clean the tracks.
Capsule caps and bodies do not separate	The upper and lower Capsule Die Segments are not in alignment.	Adjust the position of the segments with the alignment tools.
	The Capsule Die Segments are blocked.	Clean the segment holes.
	The vacuum pressure is not high enough, the pipe line is jammed, or there is an air leakage.	Ensure that the vacuum pressure is 0.06-0.08 Mpa. Check the vacuum pipes and clean the filter.
The capsule's ends are being punched through	The upper and lower Capsule Die Segments are not in alignment, or the Capsule Closing Plate is too high at the closing station.	Check the closing station and the alignment of the upper and lower Capsule Die Segments with the alignment tools.
	The Closing Pins' position is too high.	Adjust the height of the Pushing Rod.
The machine suddenly stops while running	The powder has run out.	Add more powder.
	The powder's exit is blocked.	Clear the powder's exit and remove any solids from the powder.
	Some parts of the mechanical gear may be loose or damaged, or the electric motor is overloaded.	Check the machine for any damaged or loose parts. If the electric motor is overloaded, repair and adjust accordingly.
The vacuum breaker keeps tripping	The vacuum is being overworked.	Adjust the breaker with a crosshead screwdriver to slightly raise the amps. Clean the vacuum filter and empty the vacuum bag.
The motor is running but the machine is not operating	The bolt on the motor's main gear is loose, which is affecting the drive belt's tension.	Tighten the bolt on the motor's main gear and make sure there is enough tension on the drive belt.
Powder is stuck to capsules	The powder content is sticky.	Granulate or add lubrication to your mix.

Common Issues Continued

Symptom	Possible Cause	Possible Solution
Powder is stuck to capsules	The working environment is too humid/has too much static.	Reduce the humidity and ground your machine/remove static.
No powder feeding during automatic operation	The powder height sensor of the feeder motor is damaged.	Check the sensitivity of the sensor, clean its switch, and/or adjust the sensor.
	The electrics are bad.	Check the corresponding electric circuit by referring to the electrical diagrams found in the Appendix. Contact an electrician if damaged.
Capsules are not closing	The gap of the Capsule Closing Plate is too high.	Ensure that the gap is 0.2 mm-0.3 mm.
	The powder is too fluffy, so the powder slugs are too big for the capsules.	Granulate the powder.
Filled capsules discharge unsmoothly	The capsules contain static electricity.	If there are capsules stuck to the Discharge chute, blow them off with an air compressor.
	There is a jam in the Discharge chute.	Clean the Discharge chute.
	The angle of the Capsule Closing Plate elevation is too high.	Adjust the screws to reduce the angle.
	Capsules require assistance from an air compressor.	Connect an air compressor to the capsule ejection area. The PSI required is 0.02 MPa.
Capsules are not being sewn into the Tooling	The bearing and spring inside the Capsule Gate's channel is covered with powder.	Take off the Capsule Gate, remove its set screw, spring, and ball bearing. Clear the channel of any powder and clean the spring and ball bearing.
Powder is accumulating inside the Die Segment Turret	The powder is not granulated well.	Granulate the powder before filling capsules.
	Powder is overfilling the Upper and Lower Die Segments.	Reduce the machine operation speed, reduce the fill amount and/or change to a larger capsule size.
	The Die Segment Turret has not been cleaned.	Empty the powder collector underneath the Die Segment Turret and run the vacuum cleaner.
Capsules are piling up inside the machine	Capsules are not exiting the ejection chute.	Attach an air compressor to the 8 mm push fitting underneath the capsule ejection assembly to help the capsules move in the correct direction and down the chute.
Capsule caps are sucked out of the upper segment into the capsule rejection station	The vacuum pump pressure needs to be calibrated.	Please see the vacuum pump pressure calibration instructions on page 41.

Common Issues Continued

Symptom	Possible Cause	Possible Solution
Dents and pin holes in capsules	The capsules are being overfilled.	Use larger capsules.
		Use less powder.
	The capsules have been exposed to moisture.	Improve capsule storage conditions.
	The pin sizes are incorrect or installed incorrectly.	Replace the Tooling or reinstall the pins.
Telescoped capsules	Machine components are not installed correctly or worn out.	Adjust or replace the worn out components.
	The capsule fill weight is too high.	Lower the capsule fill weight.
	The capsules' storage area experiences variation in temperature.	Store the capsules in an area with a consistent temperature.
Improperly closed capsules	There is damage to the body-cap interface (sealing area).	Replace the damaged capsules.
	The capsules are being overfilled.	Use larger capsules.
		Use less powder.
Dusty capsules	Capsules are not being polished.	Use a capsule polisher after filling capsules. Order one from LFA at https://www.lfacapsulefillers.com/cp-7000-capsule-polisher
Cracked capsules	The capsules have been exposed to moisture.	Improve capsule storage conditions.
	The Capsule Die Segments are misaligned.	Adjust the Capsule Die Segments.
	The pin sizes are installed incorrectly.	Reinstall the pins.

De-Jamming the FACF® Range

There are a couple reasons why a FACF® might jam such as:

- Disfigured capsules become lodged in magazine tracks.
- Powder builds up.

The methods that can fix a jammed FACF® follow below:

Tools and Materials Needed

- Set of metric Allen keys with ball ends
- Crosshead screwdriver
- Cleaner (e.g. Member's Mark Commercial Lemon Fresh Disinfectant)
- Sanitizer (e.g. Member's Mark Commercial Sanitizer)
- Bowl of warm soapy water (nothing abrasive)
- 3 clean cloths and a toothbrush
- Dry raw powder materials
- Disposable latex/rubber gloves (for food grade products and to protect hands from grease)
- Hairnet and/or beard net (food grade products only)
- Sterile shoe covers (food grade products only)



WARNING: To prevent any potential personal injury, ALWAYS unplug the FACF® before de-jamming it.

Instructions

Note: Wear latex/rubber gloves (and appropriate food grade attire if applicable) during this process.

Method 1: Dislodge Disfigured Capsules

1. Remove the Capsule Hopper and the Capsule Magazine with an Allen key.
 - 1.1 Note: Please refer to the remove and replace Capsule Holding Pins instructions on page 74 for further information.
2. Take apart the Capsule Magazine with an Allen key and remove any stuck/damaged capsules.
 - 2.1 Note: Please refer to the remove and replace Capsule Holding Pins instructions on page 74 for further information.

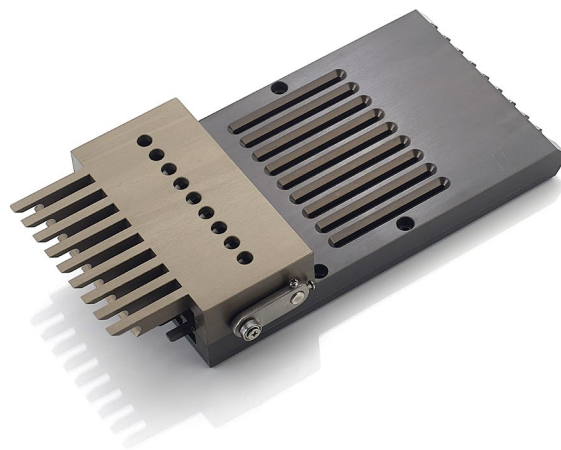

Method 2: Clean Excess Powder Buildup

1. Remove the Powder Hopper, Auger, and each part of the tamping Tooling.
 - 1.1 Note: Please refer to the remove and replace Tooling instructions on page 50 for further assistance.
2. Take one of the parts removed from the machine and bring it to the bowl of soapy water.
 - 2.1 Note: To ensure that all dirt and debris are removed, wash one part at a time.
3. Take a clean cloth and carefully wash the part thoroughly.
 - 3.1 Note: Use the toothbrush for difficult-to-remove debris. When cleaning Tooling, use non-abrasive cleaning equipment such as a soft pipe cleaner and soft cloth.
4. Dry part immediately after it is cleaned and rinsed.
5. Sanitize part with a clean cloth.
6. Repeat steps 2-5 for each remaining part until they are all clean.

Cleaning

During the FACF®'s operation, excess powder will find its way into parts of the machine, particularly in the Capsule Magazine and Tamping Turret. It is important to clean the FACF® thoroughly to prevent rusting and cross contamination.

LFA recommends that the machine be cleaned after each operation.

Tools and Materials Needed

- Cleaning brush/paintbrush
- Bagless vacuum
- Long wire pipe cleaner
- Toothbrush
- Cleaner (e.g. Member's Mark Commercial Lemon Fresh Disinfectant)
- Sanitizer (e.g. Member's Mark Commercial Sanitizer)
- Set of metric Allen keys with ball ends
- Crosshead screwdriver
- Disposable latex/rubber gloves
- Bowl of warm soapy water (nothing abrasive)
- 3 clean cloths
- Potable water
- Hairnet and/or beard net (food grade products only)
- Sterile shoe covers (food grade products only)



WARNING: To prevent any potential personal injury, ALWAYS unplug the FACF® from the electrical outlet when removing and replacing parts.

Instructions

Note: Wear latex/rubber gloves (and appropriate food grade attire if applicable) during this process.

Remove Parts

1. Remove the Capsule Hopper, Capsule Magazine, the Powder Hopper, the Auger, and the Tamping Disk station.
 - 1.1 Note: Please refer to the remove and replace Tooling instructions on page 50 for further information.
2. Take apart the Capsule Magazine.
 - 2.1 Note: Please refer to the remove and replace Capsule Holding Pins instructions on page 74 for further information.
3. Clean away any debris from inside the Capsule Magazine's tracks with a wire pipe cleaner.
4. Vacuum any excess powder from the bottom of the Tamping Turret and sanitize.

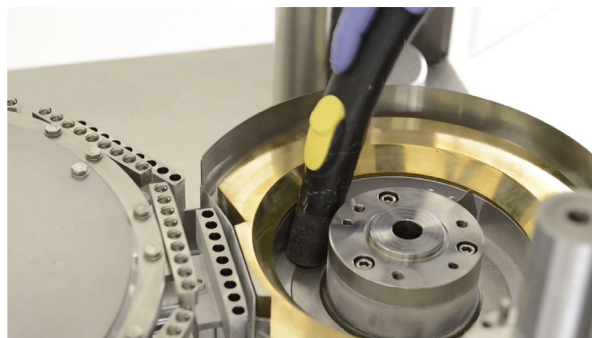

Clean the Parts

5. Take one of the parts removed from the machine and bring it to the bowl of soapy water.
5.1 Note: To ensure that all dirt and debris are removed, wash one part at a time.
6. Take a clean cloth and carefully wash the part thoroughly.
6.1 Note: Use the toothbrush for difficult-to-remove debris. When cleaning Tooling, use non-abrasive cleaning equipment such as a soft pipe cleaner and soft cloth.
7. Dry part immediately after it is cleaned and rinsed.
8. Sanitize part with a clean cloth.
9. Repeat steps 5-8 for each remaining part until they are all clean.

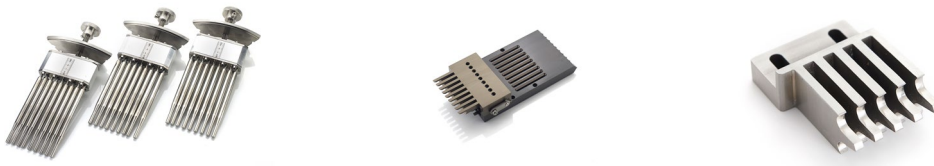

Clean the External Area

10. Spray the FACF® external area with the cleaner, particularly in the location of the Capsule Die Segments, Capsule Magazine, and Tamping Turret.

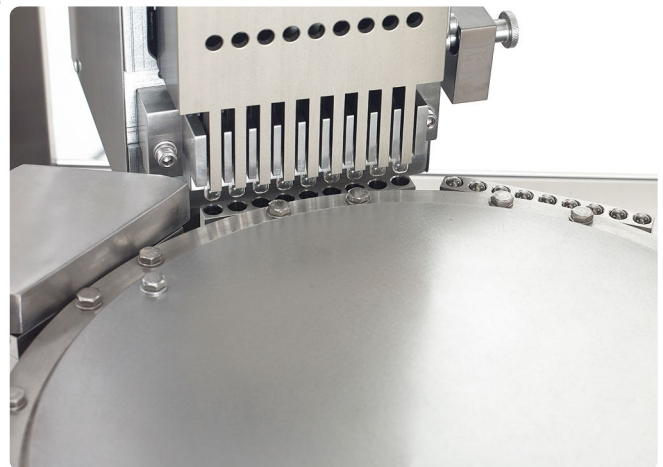

11. Rinse the cleaner off with potable water.
12. Sanitize the FACF® external area with a clean cloth.

Cleaning Schedule Matrix

Part	After Installing Machine	After Every Use	Before Every Use	Inbetween Products That Present A Cross Contamination Risk	Weekly	Monthly	Before Placing In Storage	After Removing From Storage
Capsule Hopper	Wet clean and re-lubricate if specified in lubrication schedule	Dry clean and re-lubricate if specified in lubrication schedule	Dry clean and re-lubricate if specified in lubrication schedule	Wet clean and re-lubricate if specified in lubrication schedule	Dry clean and re-lubricate if specified in lubrication schedule	Wet clean and re-lubricate if specified in lubrication schedule	Dry clean and re-lubricate if specified in lubrication schedule	Wet clean and re-lubricate if specified in lubrication schedule
Powder Hopper	Wet clean and re-lubricate if specified in lubrication schedule	Wet clean and re-lubricate if specified in lubrication schedule	Wet clean and re-lubricate if specified in lubrication schedule	Wet clean and re-lubricate if specified in lubrication schedule	Wet clean and re-lubricate if specified in lubrication schedule	Wet clean and re-lubricate if specified in lubrication schedule	Wet clean and re-lubricate if specified in lubrication schedule	Wet clean and re-lubricate if specified in lubrication schedule
Base	Wet clean and re-lubricate if specified in lubrication schedule	Dry clean and re-lubricate if specified in lubrication schedule	Dry clean and re-lubricate if specified in lubrication schedule	Wet clean and re-lubricate if specified in lubrication schedule	Dry clean and re-lubricate if specified in lubrication schedule	Wet clean and re-lubricate if specified in lubrication schedule	Dry clean and re-lubricate if specified in lubrication schedule	Wet clean and re-lubricate if specified in lubrication schedule
Upper and Lower Sections of Capsule Closing Tooling	Wet clean and re-lubricate if specified in lubrication schedule	Wet clean and re-lubricate if specified in lubrication schedule	Wet clean and re-lubricate if specified in lubrication schedule	Wet clean and re-lubricate if specified in lubrication schedule	Wet clean and re-lubricate if specified in lubrication schedule	Wet clean and re-lubricate if specified in lubrication schedule	Wet clean and re-lubricate if specified in lubrication schedule	Wet clean and re-lubricate if specified in lubrication schedule
Capsule Magazine and Teeth	Wet clean and re-lubricate if specified in lubrication schedule	Dry clean and re-lubricate if specified in lubrication schedule	Dry clean and re-lubricate if specified in lubrication schedule	Wet clean and re-lubricate if specified in lubrication schedule	Wet clean and re-lubricate if specified in lubrication schedule	Wet clean and re-lubricate if specified in lubrication schedule	Dry clean and re-lubricate if specified in lubrication schedule	Wet clean and re-lubricate if specified in lubrication schedule
Tamping Turret and Stations	Wet clean and re-lubricate if specified in lubrication schedule	Dry clean with cloth	Wet clean and re-lubricate if specified in lubrication schedule	Wet clean and re-lubricate if specified in lubrication schedule	Dry clean with cloth	Wet clean and re-lubricate if specified in lubrication schedule	Dry clean with cloth	Wet clean and re-lubricate if specified in lubrication schedule

Cleaning Level Key

Level 1 - Remove powder
Level 2 - Dry clean with cloth
Level 3 - Dry clean and re-lubricate if specified in lubrication schedule
Level 4 - Wet clean and re-lubricate if specified in lubrication schedule
Remove from machine - Take part out of machine and clean if required. Store it correctly or install back into machine.
Install into machine - Install part into the machine and make sure that it has been cleaned. If needed, lubricate to the level required.
Clean on/in machine - Clean the part while in the machine and do not remove it. Make sure that all contact surfaces are clean to the level required.

This cleaning matrix is intended as a guide only and is not an exhaustive list. All cleaning schedules will need to be adapted to the industry and product, following industry regulations and the material safety data sheets that come with specific products. Please check with your Food Safety Manager/Department, Quality Control Manager/Department, or other relevant internal departments at your company before using.

Storing the FACF® Range

After its thorough cleaning, the FACF® needs to be stored in the proper conditions. It is important to store it in an environment in which the machine is safe from rusting. The FACF®'s high traction areas and the Tooling need to be lubricated separately before you store them.

Tools and Materials Needed

- Plastic wrapping to cover machine
- Container(s) for Tooling (if in storage for more than a week)
- Lubricant/grease (NSF approved lubricant if machine has a high chance of contact with the food or drug product)
- Disposable latex/rubber gloves (for food grade products and to protect hands from lubricant)
- Hairnet and/or beard net (food grade products only)
- Sterile shoe covers (food grade products only)

Instructions

Note: Wear latex/rubber gloves (and appropriate food grade attire if applicable) during this process.

Lubricating the Tooling

If you are not using the machine for more than a week, store the Tooling in containers and cover it with lubricant to prevent rust formation. If not, simply lubricate each part of the Tooling and reinsert it back into the machine.

Lubricating the Grease Points and High-Traction Parts

1. Apply one layer of grease onto the work surface of the cams and rollers.
 - 1.1 Note: To see drawings of lubrication point locations, please refer to the Lubrication Schedule on page 46.
2. Apply lubrication oil to joint bearings, sealing bearings, and sliding guides.
3. Grease the ball bearings, needle bearing, and linear bearings.
4. Check the driving chains' tightness and apply lubricant.
5. Replenish the oil of the main driving and feeder decelerators.

Environmental Conditions

It is important that the environment in which you operate and store the FACF® has the appropriate temperature and relative humidity levels. These two environmental factors can potentially cause the machine to rust and/or cause the capsules to have a lower quality. The table below shows the acceptable temperature and relative humidity levels:

Machine	Temperature		Humidity
FACF®	°C	°F	45-55% RH
	18-24	64-75	

Appendix

Glossary

Term	Definition
API/Active Pharmaceutical Ingredient	Any substance or mixture of substances used that is an active ingredient in the drug product.
Capsule Closing Plate	Plastic part with a chamfered edge that is secured over the Tooling. The filled capsule halves are sealed against the Capsule Closing Plate.
Capsule Magazine	The unit in which the capsules are inserted and oriented. It also feeds the capsule halves into the Tooling.
Capsule Sewing Section	Area of machine in which the capsules are oriented and fed into the Tooling.
Excipient	An inactive substance that serves as the vehicle or medium for a drug or other API.
Formulation	Powder mix of the excipient and the API that is used to fill capsules.
Megapascal (MPa)	The measure of force per unit area and defined as one newton per square meter.
Tamping Turret	Area of the machine in which powder slugs are formed and tamped into the capsule halves by the Tooling.
Tooling	Enables a fully automatic capsule filler to fill and seal capsules. The Tooling can be found in the Capsule Sewing Section, Tamping Turret, and Capsule Ejection Section.

Description of FACF® Range Parts

Filter Bag for Capsule Filler Vacuum Pump

The Filter Bag for the Capsule Filler Vacuum Pump catches dust and debris that come from the machine's operation. Order at <https://www.lfacapsulefillers.com/filer-bag-capsule-filler-vacuum-pump>

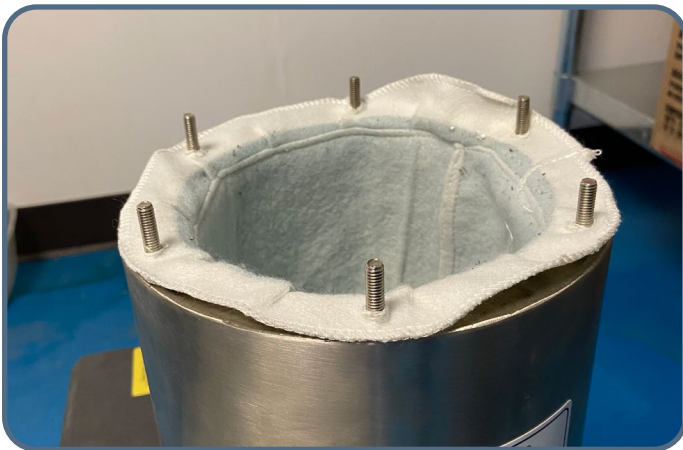

Vacuum Bag for TabVac Dust Vacuum

The Vacuum Bag for the TabVac catches the excess powder dust generated by the capsule filler. Order at <https://www.lfacapsulefillers.com/vacuum-bag-tabvac-dust-vacuum>



Tooling

The Tooling consists of the following:

- Capsule Orientation Teeth
- Tamping Pins
- Capsule Alignment Pins
- Dosing Alignment Pins
- Capsule Magazine
- Capsule Orientation Block
- Dosing Disk
- Capsule Segment Plates
- Capsule Sealing Pins
- Ejection Pin
- Alignment Pin (for Capsule Orientation Block and upper segment)
- Alignment Pin (for Ejection Pin and segments)

They all work as a set to fill the powder into capsules. Order at <https://www.lfacapsulefillers.com/fac-range-plates-moulds-set>



Capsule Suction Distribution Manifold

The Capsule Section Distribution Manifold is located in the Vacuum Plate Assembly. Order at <https://www.lfacapsulefillers.com/capsule-suction-distribution-manifold-fac-range>

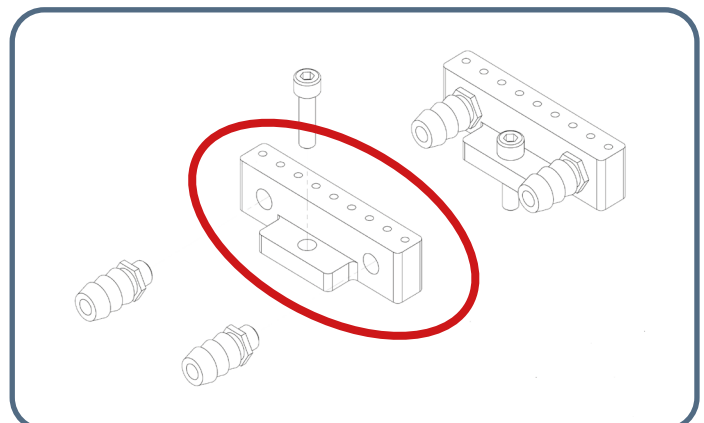

Dosing Plate

The Dosing Plate is located in the Tamping Bowl and is part of the Dosing Panel Assembly. Order at <https://www.lfacapsulefillers.com/dosing-plate-fac-1200>

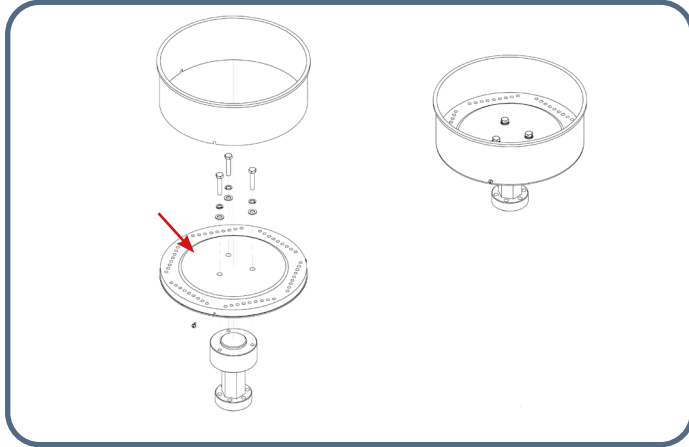

Dosing Disk Powder Loop

The Dosing Disk Powder Loop sits on top of the Dosing Plate and is part of the Dosing Panel Assembly in the Tamping Station. Order at <https://www.lfacapsulefillers.com/dosing-Disk-powder-loop-fac-1200>

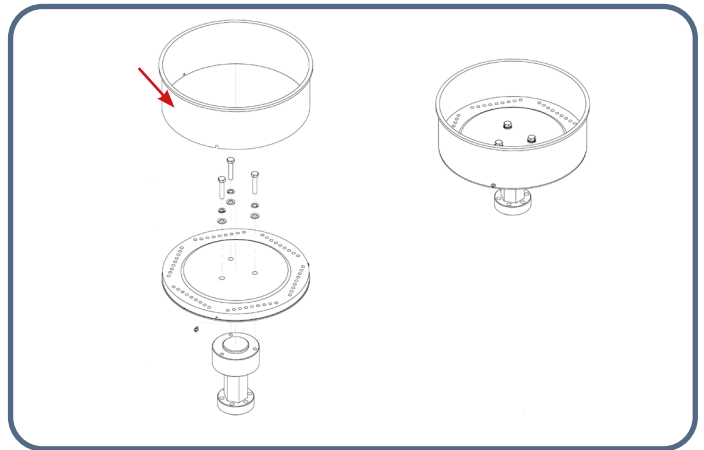

Capsule Filler Vacuum Pump

The Capsule Filler Vacuum Pump works with the Capsule Sewing Section. Order at <https://www.lfacapsulefillers.com/capsule-filler-vacuum-pump>



Food Grade Point of Contact Parts

Contact Part	Material
Tooling Plates and Molds	LY12 aluminum alloy and SUS304
Powder Hopper	SUS304
Capsule Hopper	SUS304
Alignment Tools	SUS304

Technical Specifications

Product	FACF 400®	FACF 1200®	FACF 2000®	FACF 3800®
Maximum Capsules per Minute	400	1,200	2,000	3,800
Capsule Size	00 / 0 / 1 / 2 / 3 / 4 / 5	00 / 0 / 1 / 2 / 3 / 4 / 5	00 / 0 / 1 / 2 / 3 / 4 / 5	00 / 0 / 1 / 2 / 3 / 4 / 5
Filling Precision	±3%	±3%	±3%	±3%
Filling Bores	3	9	18	27
Decibels (dB)	≤70	≤70	≤78	≤78
Weight (kg /lbs)	850 kg / 1,874 lbs	850 kg / 1,874 lbs	1700 kg / 3,748 lbs	1850 kg / 4,078 lbs
Power USA	220 V; 3 phase Wye (Y); 5.5 kW; 60 Hz	220 V; 3 phase Wye (Y); 5.5 kW; 60 Hz	220 V; 3 phase Wye (Y); 7 kW; 60 Hz	220 V; 3 phase Wye (Y); 7 kW; 60 Hz
Voltage UK	440 V; 3 phase Wye (Y); 5.5 kW; 50 Hz	440 V; 3 phase Wye (Y); 5.5 kW; 50 Hz	440 V; 3 phase Wye (Y); 7 kW; 50 Hz	440 V; 3 phase Wye (Y); 7 kW; 50 Hz
Dimensions (mm / in)	800 mm x 970 mm x 1870 mm 31.5 in x 38.1 in x 73.6 in	800 mm x 970 mm x 1870 mm 31.5 in x 38.1 in x 73.6 in	1410 mm x 1200 mm x 2100 mm 41.3 in x 47.2 in x 82.6 in	1470 mm x 1850 mm x 2080 mm 57.87 in x 72.8 in x 81.88 in
Dimensions with suggested working clearance (mm / in)	1700 mm x 1870 mm x 2770 mm 31.5 in / 38.1 in / 73.6 in	1700 mm x 1870 mm x 2770 mm 31.5 in / 38.1 in / 73.6 in	1950 mm x 1280 mm x 2000 mm 55.51 in x 50.39 in x 78.74 in	1950 mm x 1144 mm x 2000 mm 55.51 in x 45.03 in x 78.74 in
Floor Loading Limit (Static)	15.12 kN/m ²	15.12 kN/m ²	42.67 kN/m ²	41.35 kN/m ²

Capsule Production Rates

Machine	Capsule Size	Maximum Output per Minute
FACF 400®	#000	180
FACF 400®	#00, #00el, #0el	360
FACF 400®	#0, #1, #2, #3, #4, #5	400
FACF 1200®	#000	550
FACF 1200®	#00, #00el, #0el	1,100
FACF 1200®	#0, #1, #2, #3, #4, #5	1,200
FACF 2000®	#000	900
FACF 2000®	#00, #00el, #0el	1,800
FACF 2000®	#0, #1, #2, #3, #4, #5	2,000
FACF 3800®	#000	1,500
FACF 3800®	#00, #00el, #0el	3,000
FACF 3800®	#0, #1, #2, #3, #4, #5	3,500







Dust Collector Specifications







Name	FACF 400/1200
Voltage (US)	208 V and 60 Hz
Voltage (UK)	380 V/415 V and 50 Hz
Rated power	2.2 KW
Flow rate	318 m ³ /h
Noise level	≤75 dB
Package size (mm)	1100 × 750 × 1600
Dimensions (mm)	970 × 650 × 1450
Net weight	120 kg

Vacuum Pump Specifications





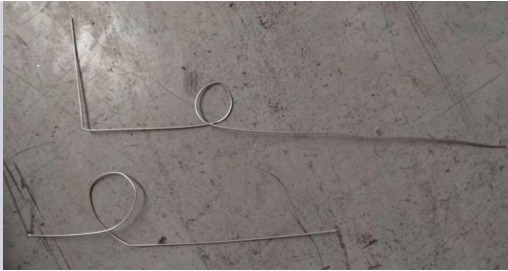

Name	Vacuum Pump
Suction air rate	67 m ³ /h (50Hz) / 78.5 m ³ /h (60Hz)
Vacuum	100 mbar
Motor capacity necessary	1.7 kW (50 Hz) / 2.2 kW (60 Hz)
Motor capacity installed	2.4 kW (50Hz) / 3.0 kW (60Hz)
Speed (rpm)	1420 (50Hz) / 1715 (60Hz)
Noise level	72 dB(A) (50Hz) / 75 dB(A) (60Hz)
Gross weight	69 kg
Dimensions (mm)	709 × 190 × 312





Toolbox Contents

	Part Name	Specifications	Quantity	Photo
1	Toolbox		1	
2	Electrical Cabinet Keys		3	
3	Clamp	32 x 44	3	
4	Wrench for Dosing Disk		1	
5	Crosshead Screwdriver		1	
6	Flathead Screwdriver		1	

	Part Name	Specifications	Quantity	Photo
7	Wrench Set	6 mm - 24 mm	1	
8	Double-End Wrench		3	
9	Allen Key Set		1	
10	Feeler Gauge	0.02 - 1 mm	1	
11	Capsule Removal Needle	0 - 041	2	
12	Brush		2	

	Part Name	Specifications	Quantity	Photo
13	Upper Mold Frame Dismount Tool	6 mm - 24 mm	1	
14	Capsule Gate Teeth	6 - 15	1	
15	Allen Key	12	1	
16	Outer Hexagonal Bolts	M6 x 16	12	
17	Outer Hexagonal Bolts	M6 x 12	8	
18	Outer Hexagonal Bolts	M8 x 35	2	

	Part Name	Specifications	Quantity	Photo
19	Extended Powder Hopper		1	
20	Anti-vibration Feet		4	
21	Dosing Disk Alignment Pins - FACF Range		2	
22	Capsule Segment Alignment Pins - FACF Range		2	
23	Capsule Magazine Alignment Pins - FACF Range		2	
24	Capsule Sealing Pins - FACF Range		9	

	Part Name	Specifications	Quantity	Photo
25	Capsule Ejection Pin - FACF Range		9	
26	Tamping Pins - FACF Range		9	
27	Capsule Sealing/ Ejection Alignment Pins - FACF Range		2	
28	T-Shaped Wrench		1	

Maintenance Checklist

Before Operation	
<input type="checkbox"/>	Visually inspect the fully automatic capsule filler and the parts.
<input type="checkbox"/>	Ensure all nuts and bolts are tight.
<input type="checkbox"/>	Visually inspect grease points and regrease where necessary.
<input type="checkbox"/>	Run the machine at a slow speed to ensure that everything is operating correctly.
<input type="checkbox"/>	Visually inspect electrical wires for any damage.
During Operation	
<input type="checkbox"/>	Tune the fully automatic capsule filler until the capsule fill and weight are correct.
<input type="checkbox"/>	Listen for irregular knocking or clicking sounds. If heard, stop operation, dislodge any stuck capsules from the machine, adjust the Capsule Holding Pins, and lubricate the machine.
<input type="checkbox"/>	Watch for buildup of powder on the Auger inside the Powder Hopper. If occurring, either (a) make mix more granular, (b) check the Auger for damage, or (c) clear the buildup.
<input type="checkbox"/>	Occasionally check the Motor's temperature. If it starts to overheat, turn off the machine, let it cool down, and grease it to ensure smooth operation.
<input type="checkbox"/>	Ensure that the Hoppers do not run out of powder and capsules.
<input type="checkbox"/>	Weigh five or ten sample capsules to ensure the desired weight and fill are being met.
<input type="checkbox"/>	Check to see that the Emergency Stop properly works.
After Operation	
<input type="checkbox"/>	Unplug machine and remove all excess powder with a bagless vacuum.
<input type="checkbox"/>	Clean the Capsule Hopper, the Powder Hopper, the Capsule Magazine and teeth, the Tooling, and the Auger.
<input type="checkbox"/>	Wipe down the other surfaces with a damp cloth.
<input type="checkbox"/>	Lubricate all grease points.
<input type="checkbox"/>	Store Tooling in a container with a small amount of grease.

Diagrams

FACF 400/1200® Floor Plan

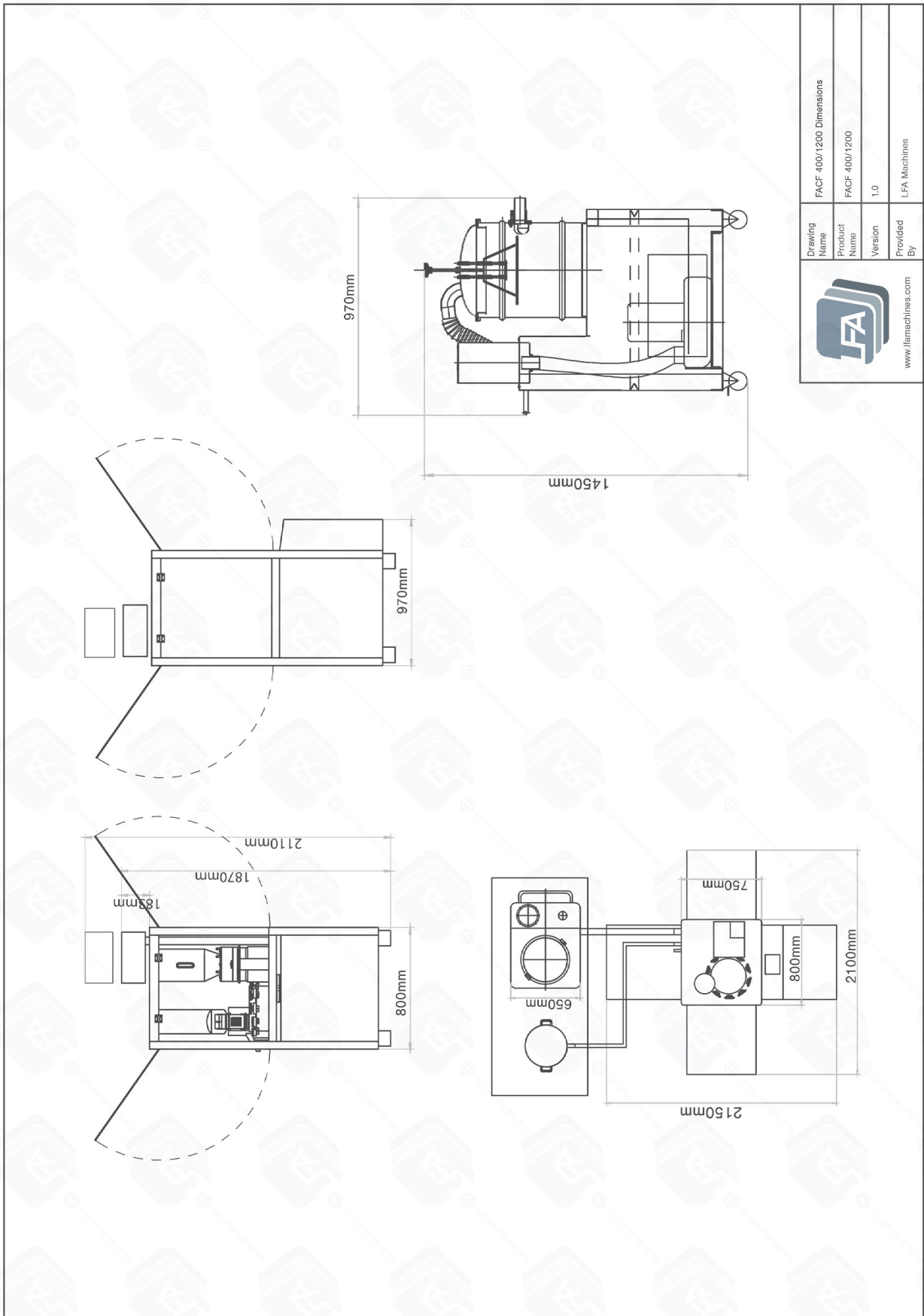

FACF 1200® Wiring Diagram 1

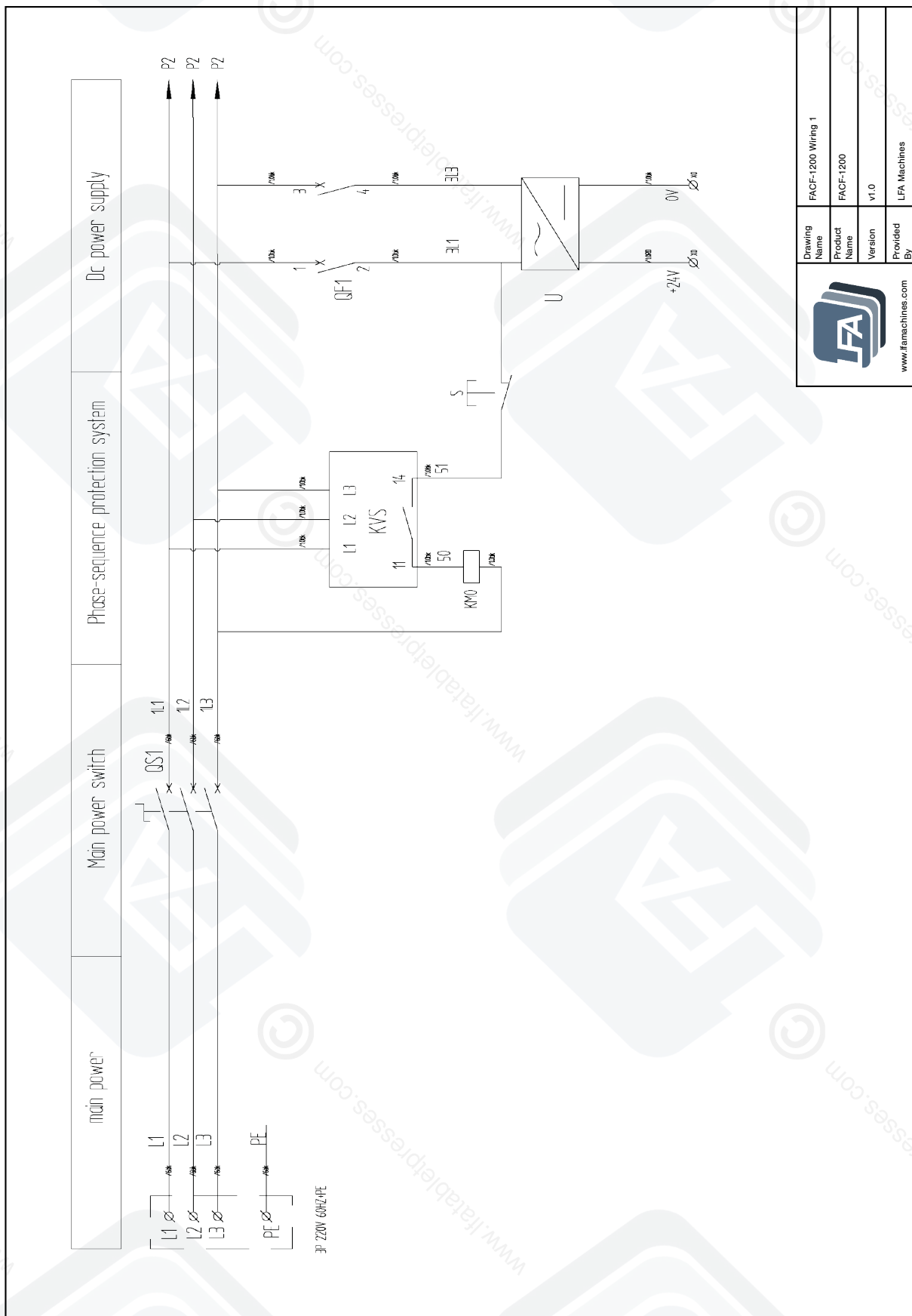

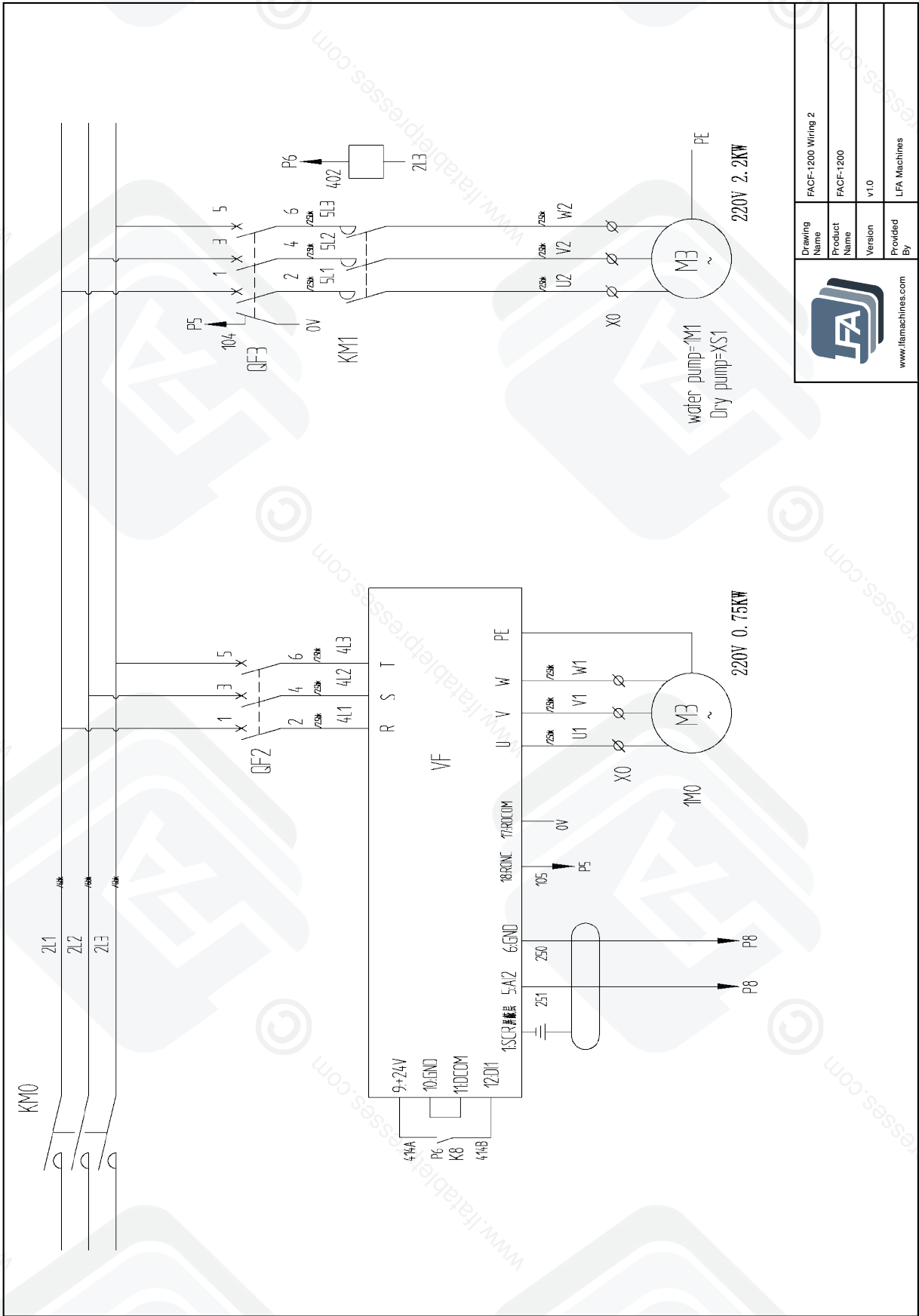

 www.lfamachines.com	Drawing Name	FACF-1200 Wiring 1
	Product Name	FACF-1200
	Version	v1.0
	Provided By	LFA Machines

FACF 1200® Wiring Diagram 2

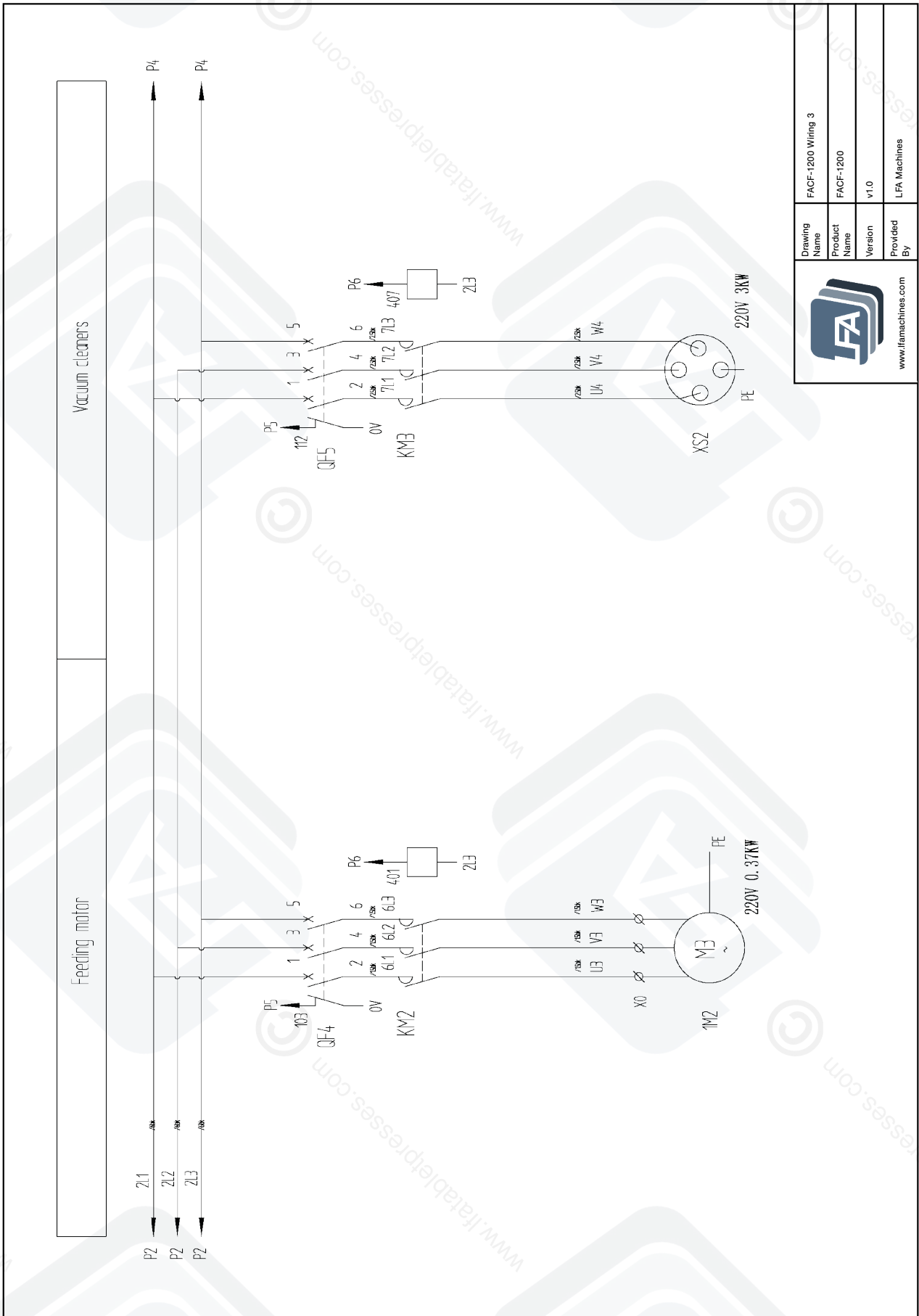

FACF 1200® Wiring Diagram 3



 www.lfamachines.com	Drawing Name	FACF-1200 Wiring 3
	Product Name	FACF-1200
	Version	v1.0
	Provided By	LFA Machines

FACF 1200® Wiring Diagram 4

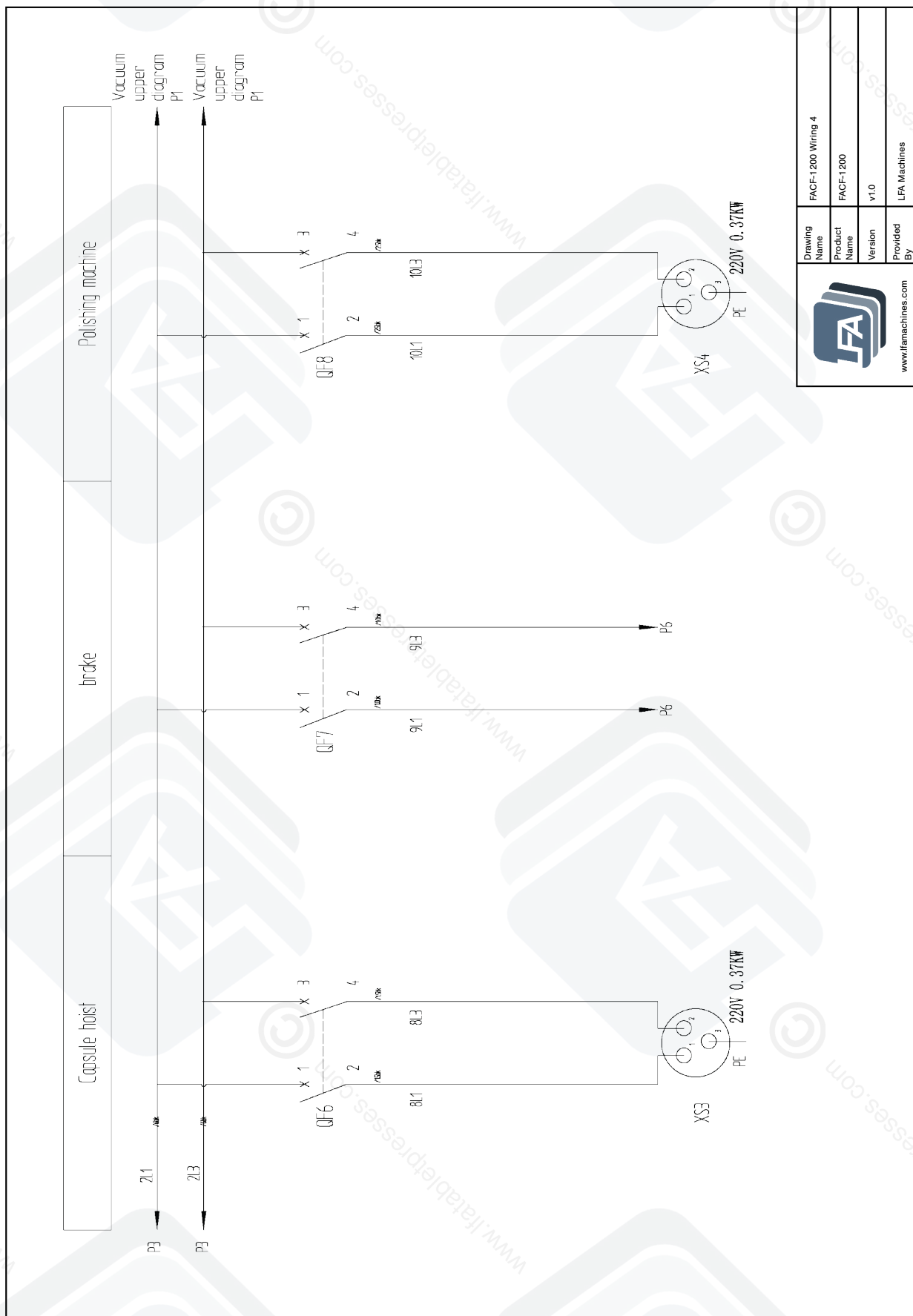



Drawing Name	FACF-1200 Wiring 4
Product Name	FACF-1200
Version	v1.0
Provided By	LFA Machines

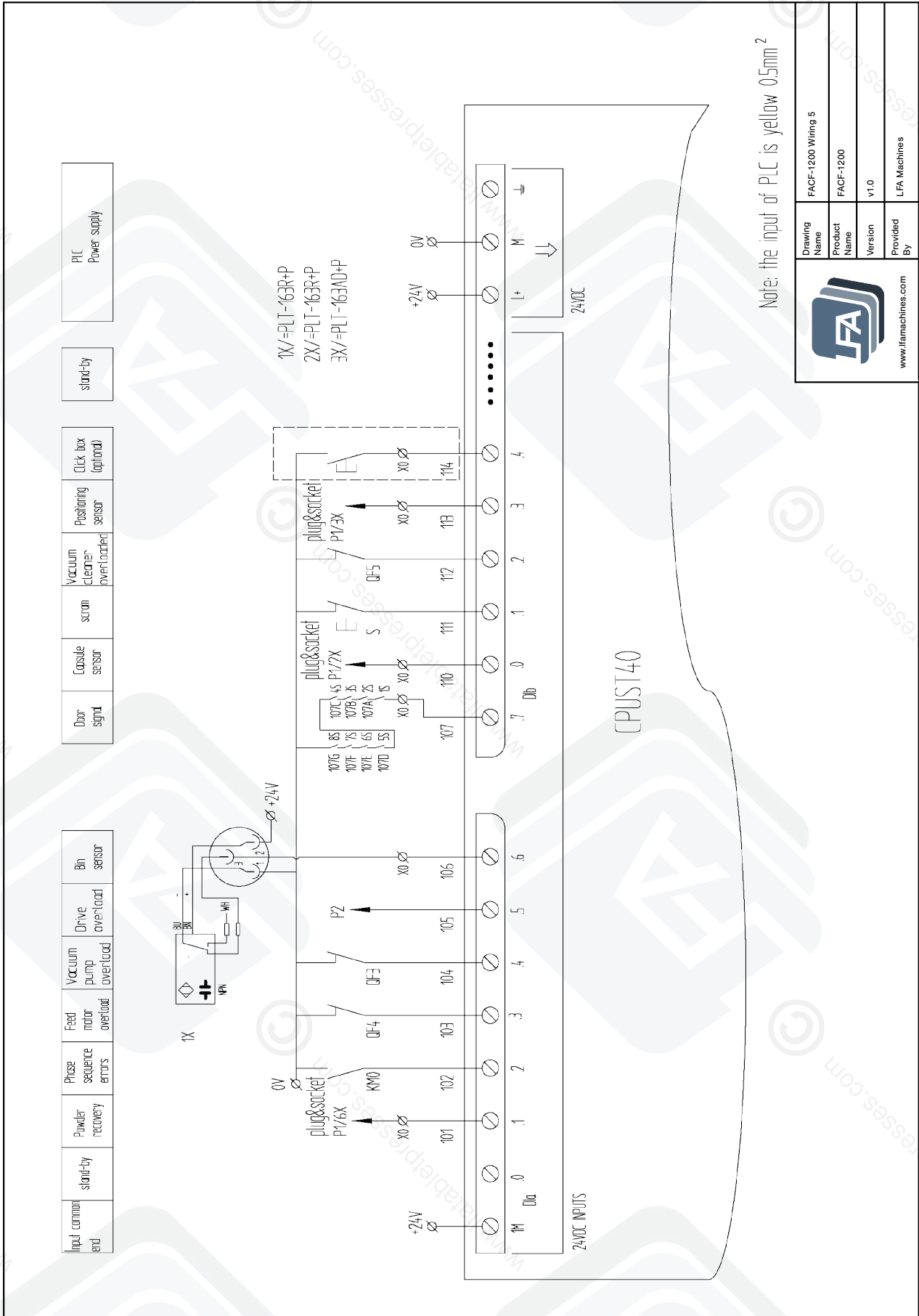

www.lfamachines.com

FACF 1200® Wiring Diagram 5



 www.lfamachines.com	Drawing Name	FACF-1200 Wiring 5
	Product Name	FACF-1200
	Version	V1.0
	Provided By	LFA Machines

FACF 1200® Wiring Diagram 6

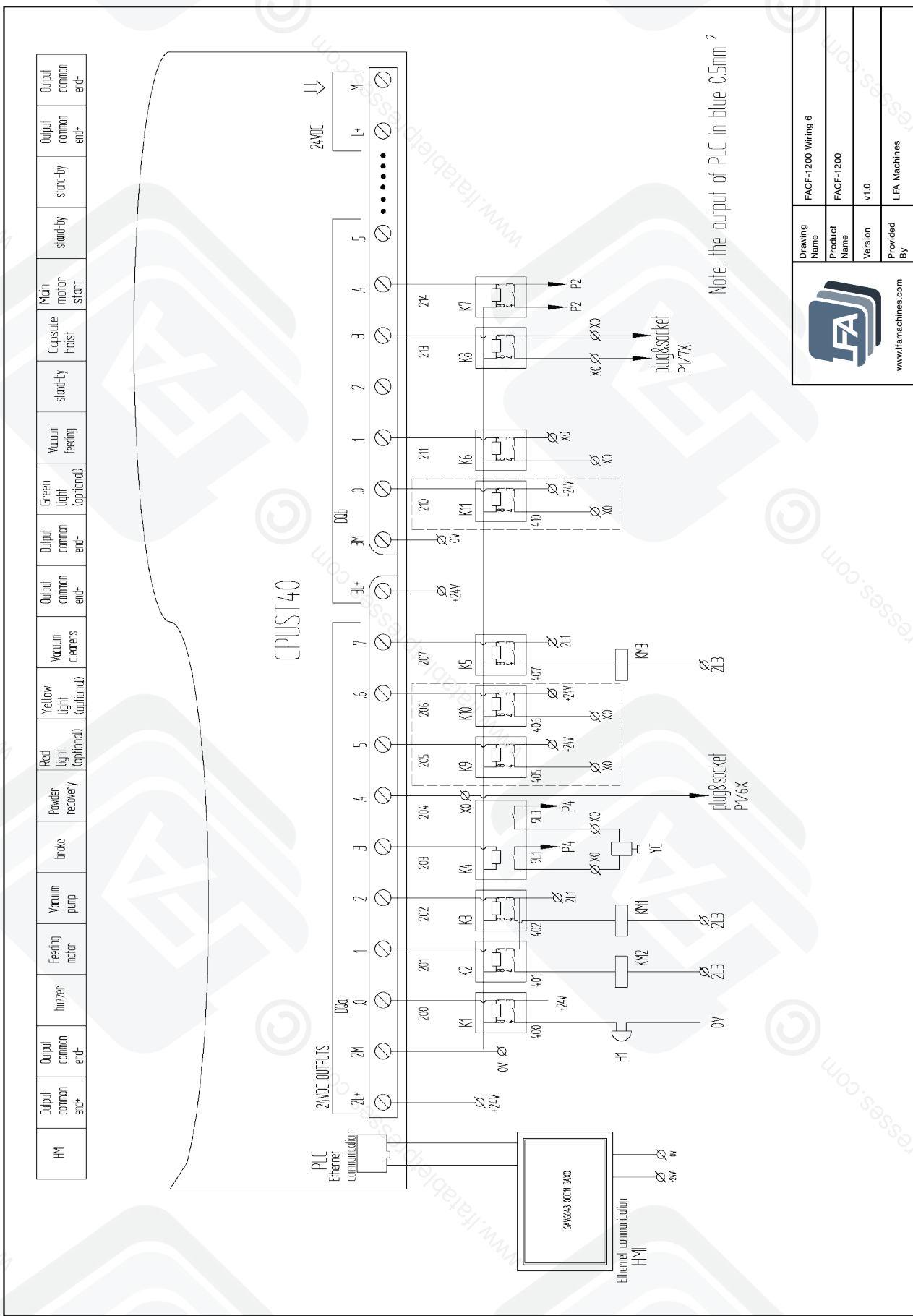



Drawing Name	FACF-1200 Wiring 6
Product Name	FACF-1200
Version	v1.0
Provided By	LFA Machines

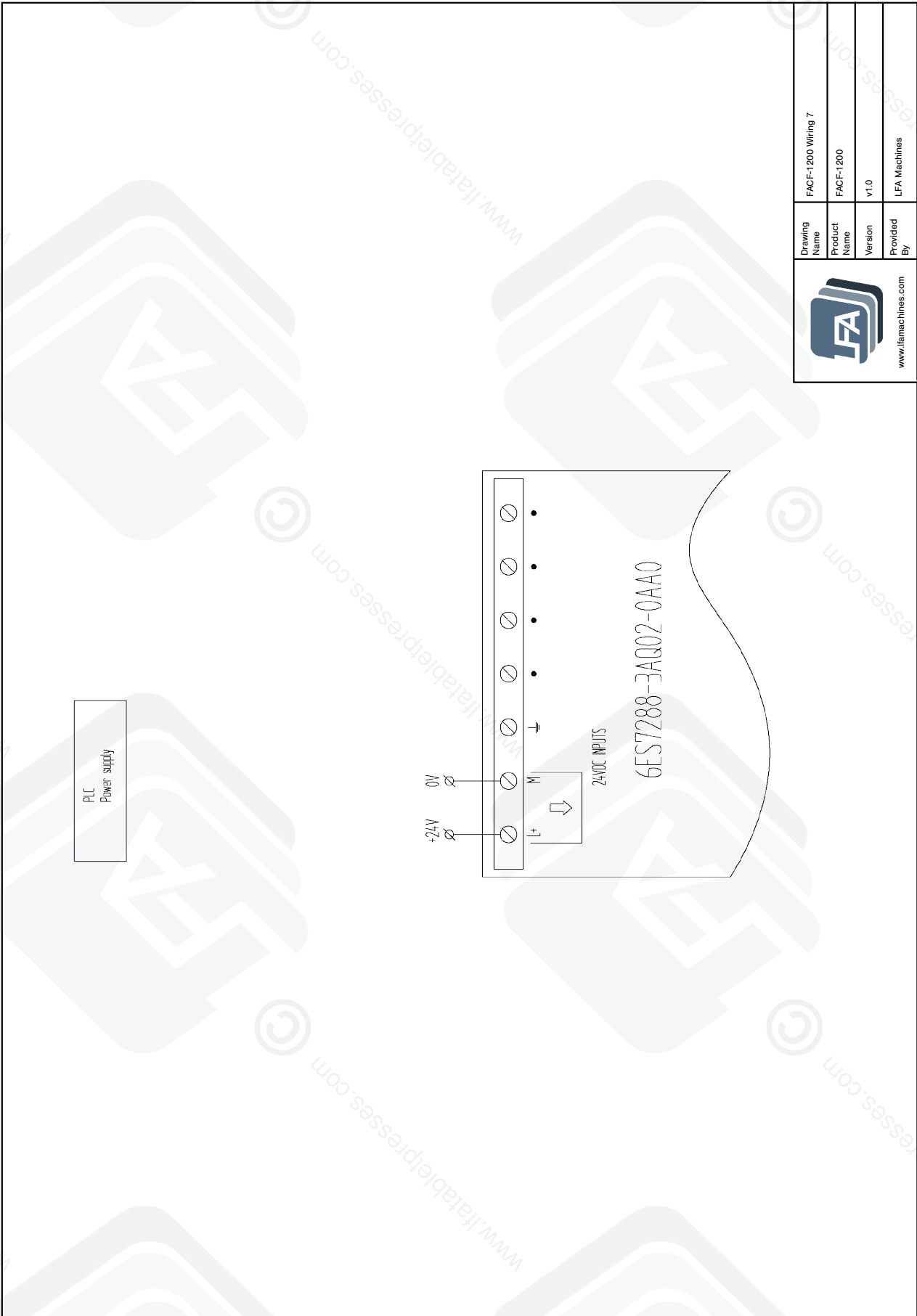

www.lfamachines.com

FACF 1200® Wiring Diagram 7



 www.lfamachines.com	Drawing Name	FACF-1200 Wiring 7
	Product Name	FACF-1200
	Version	v1.0
	Provided By	LFA Machines

FACF 1200® Wiring Diagram 8

Converters communicate stand-by

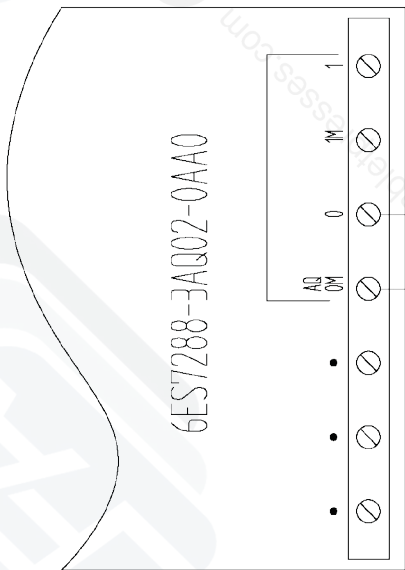

Note: the output of PLC in blue 0.5mm²

 www.lfamachines.com	Drawing Name FACF-1200 Wiring 8
	Product Name FACF-1200
	Version v1.0
	Provided By LFA Machines

FACF 1200® Wiring Diagram 9

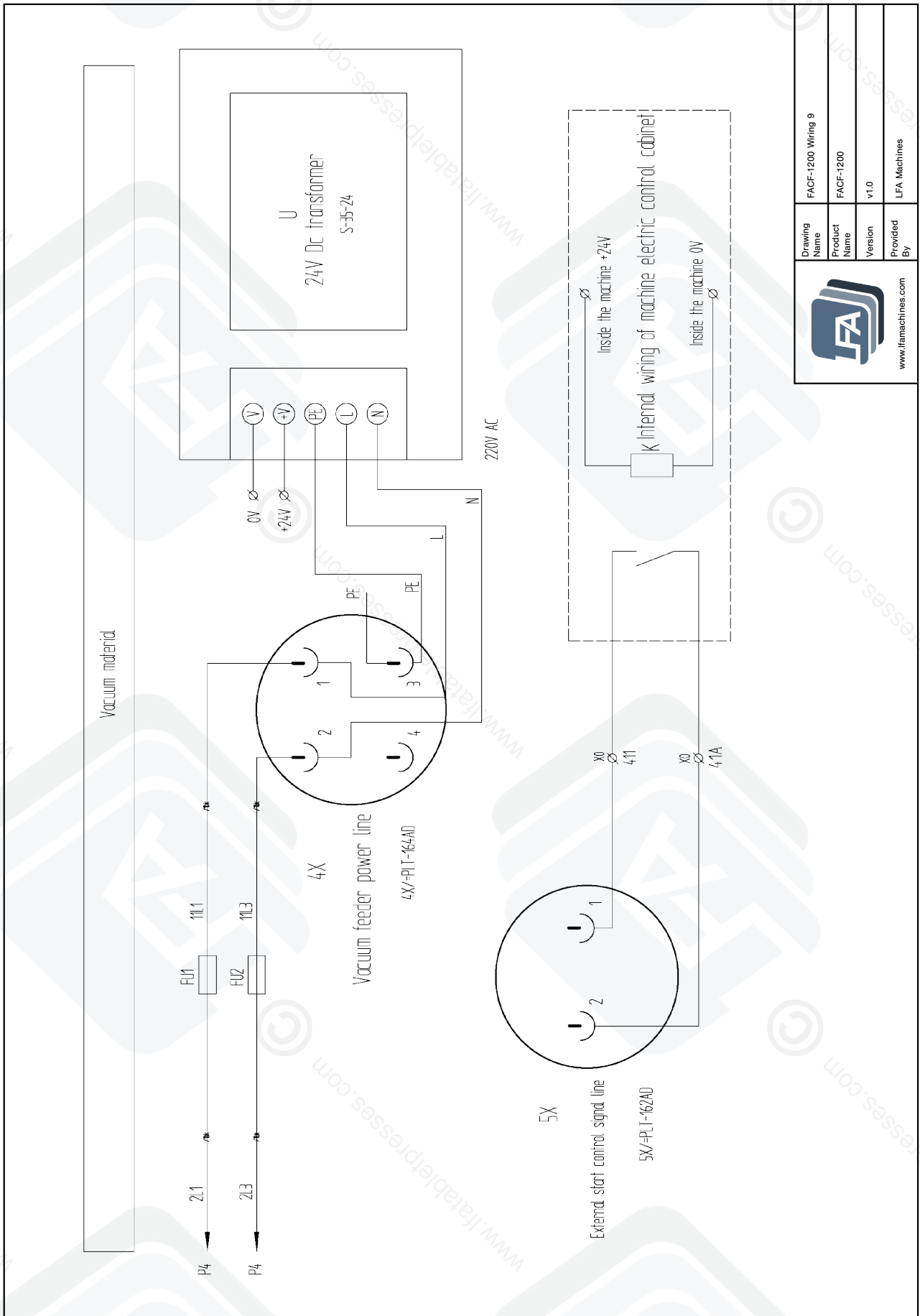

 www.lfamachines.com	Drawing Name	FACF-1200 Wiring 9
	Product Name	FACF-1200
	Version	V1.0
	Provided By	LFA Machines

FACF 1200® Wiring Diagram 10

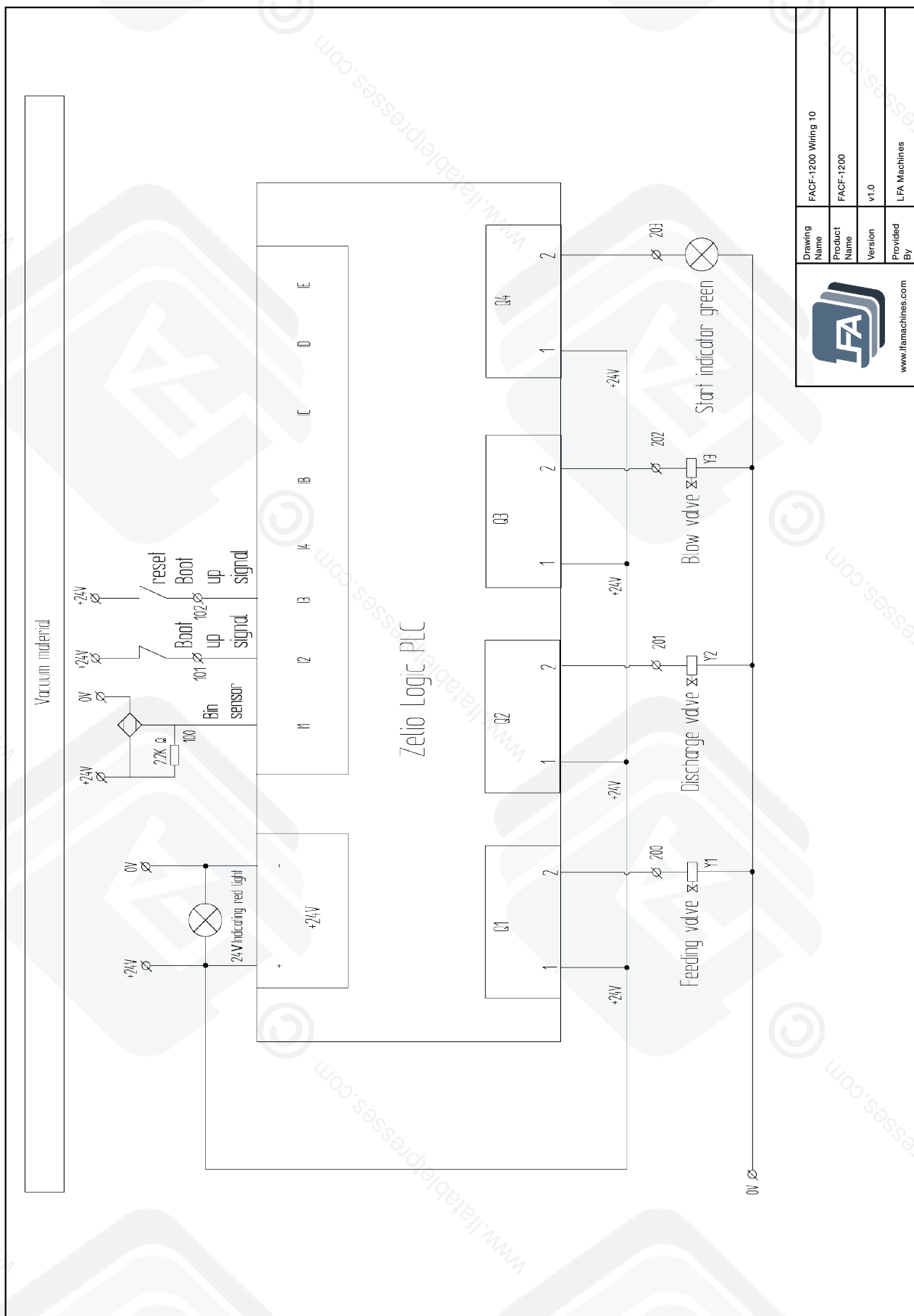

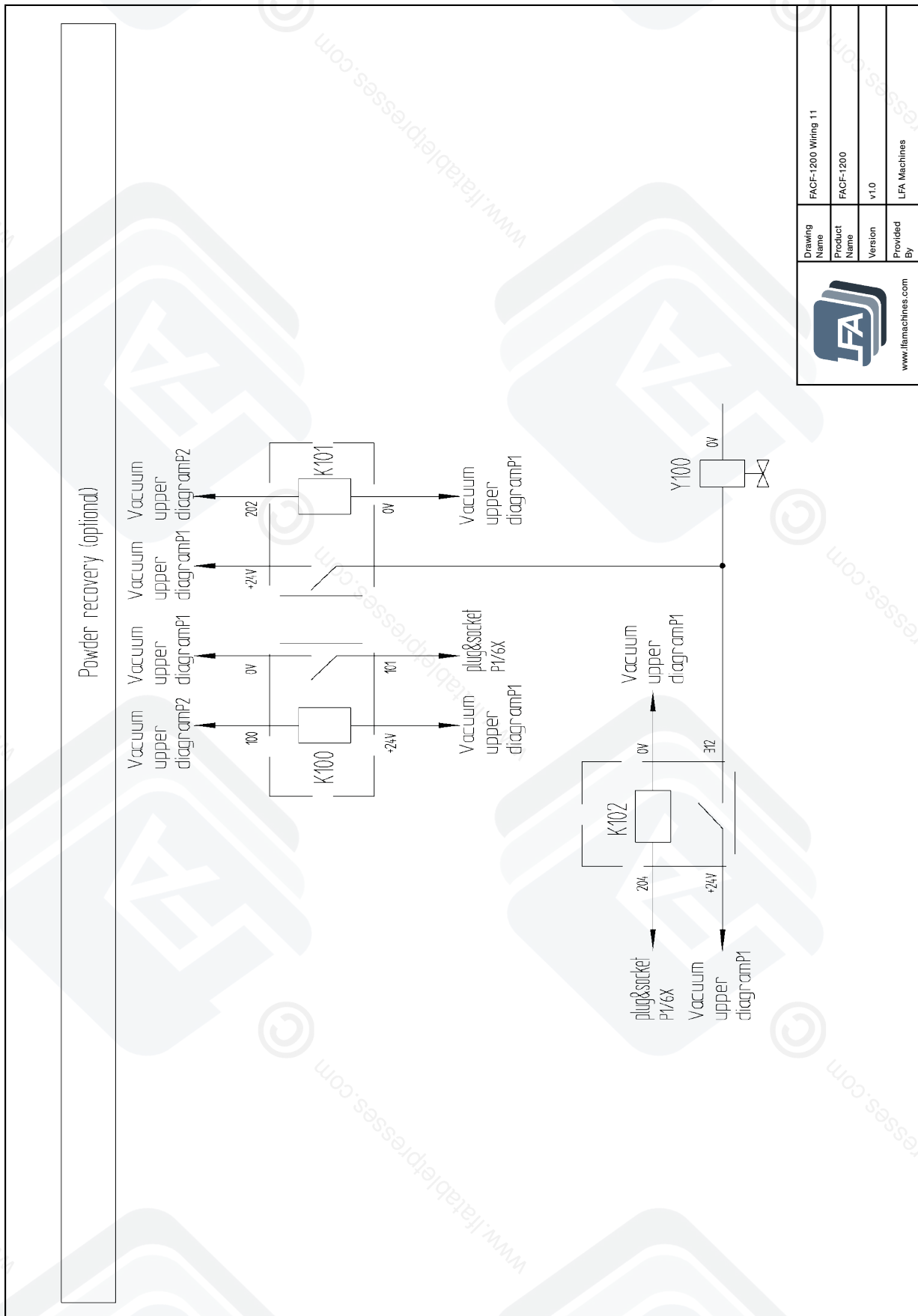

 www.lfamachines.com	Drawing Name	FACF-1200 Wiring 10
	Product Name	FACF-1200
	Version	v1.0
	Provided By	LFA Machines

FACF 1200® Wiring Diagram 11



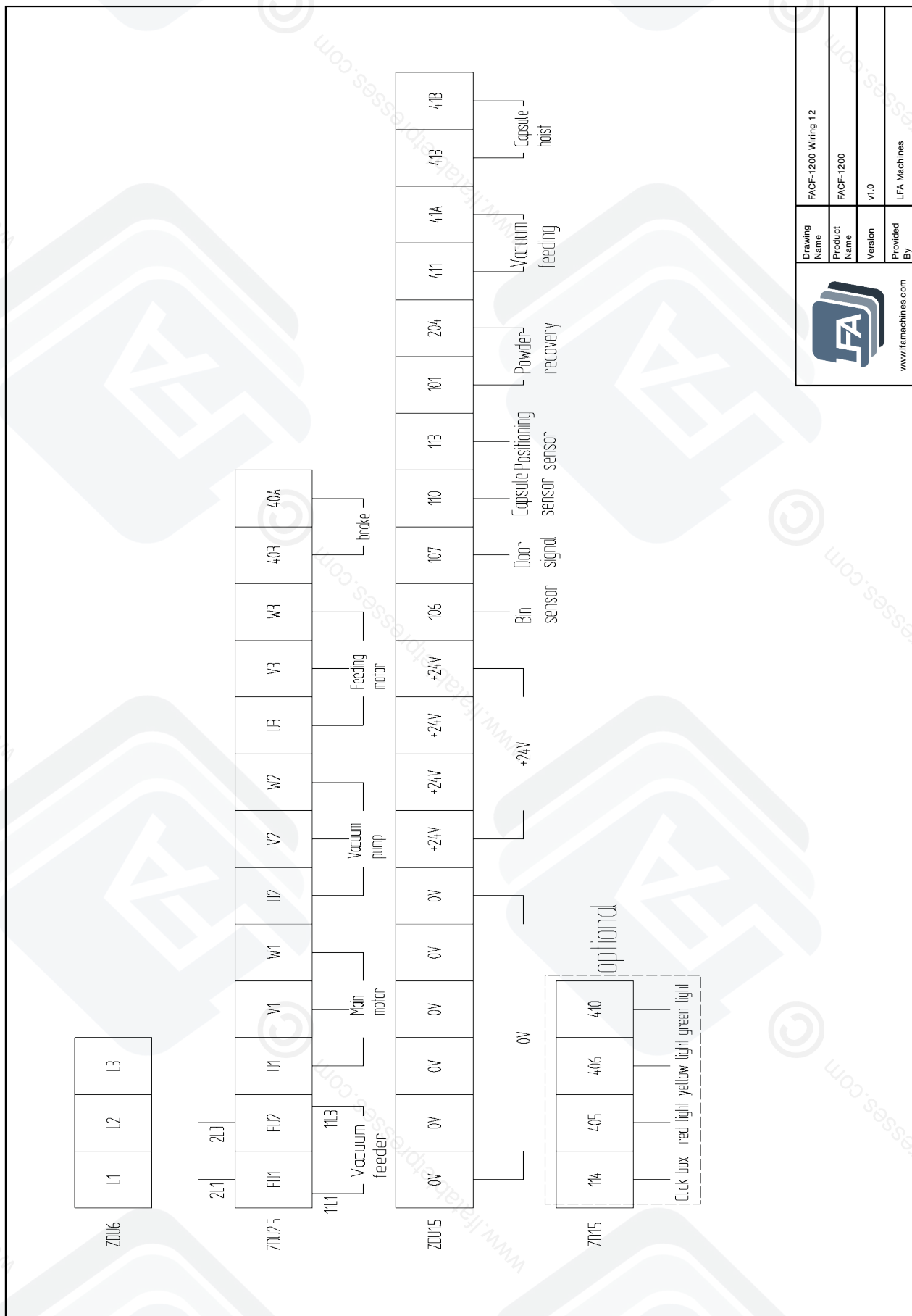

FACF 1200® Wiring Diagram 12

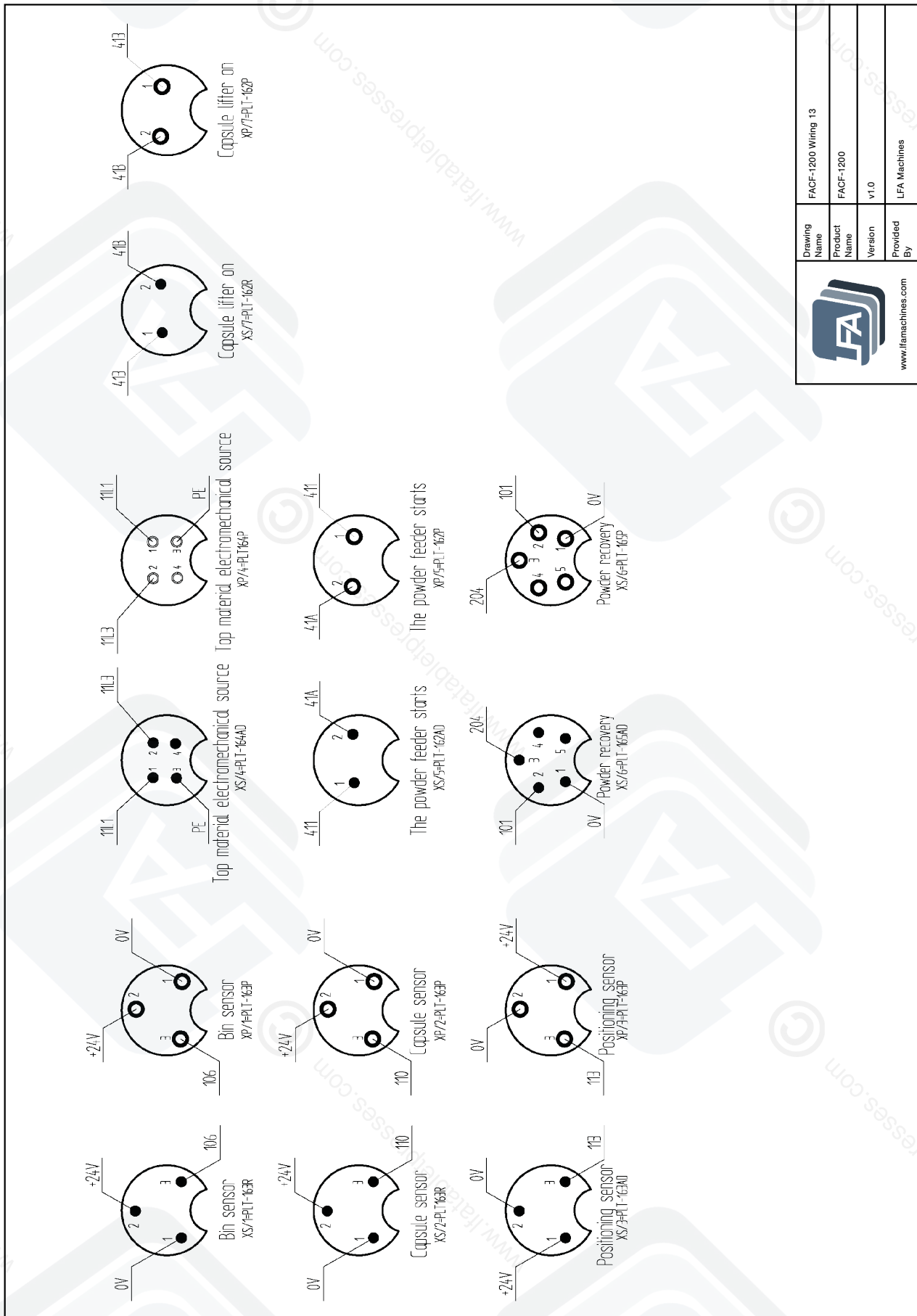

 www.lfamachines.com	Drawing Name	FACF-1200 Wiring 12
	Product Name	FACF-1200
	Version	v1.0
	Provided By	LFA Machines

FACF 1200® Wiring Diagram 13



 www.lfamachines.com	Drawing Name	FACF-1200 Wiring 13
	Product Name	FACF-1200
	Version	v1.0
Provided By	LFA Machines	

FACF 1200® Wiring Diagram 14

Components list

No.	Symbol	Description	Model	No.	Symbol	Description	Model	No.	Symbol	Description	Model
1	CPUS140	PLC	6ES7288-1400AA0	14	KM1	contactor	3RT6026-1AN20				
2	VF	VFD	ACS335-0QE-07A5-2	15	KM2	contactor	3RT6016-1AN21				
3	HMI	Siemens touch screen	6AV6648-0CC11-3AX0	16	KM3	contactor	3RT6026-1AN20				
4	QS1	Power switch	PI-3Z	17	U	Dr. power supply	LFS-50-24				
5	QF1	air switch	5SL62047CC	18	KVS	Phase sequence protector	3UG4512-1AR20				
6	QF2	air switch	5SL63167CC	19	K	weidmueller relay	DR424024ID/SI02CECO				
7	QF3	switch	3RV6011-1KA10	20	X0	weidmueller terminal	ZDU15/ZDU2.5/ZDU6				
8	QF4	switch	3RV6011-1CA10	21	H1	buzzer	HRB-PS30-DC24V				
9	QF5	switch	3RV6011-1KA10	22	XS1	Dry pump socket	5623				
10	QF6	air switch	5SL62167CC	23	XS2	Vacuum socket	5618				
11	QF7	air switch	5SL62047CC	24	XS3	Capsule host source	5601				
12	QF8	air switch	5SL62167CC	25	XS4	Polished electromechanical source	5601				
13	KM0	contactor	3RT6027-1AN20								

 www.lfamachines.com	Drawing Name	FACF-1200 Wiring 14
	Product Name	FACF-1200
	Version	v1.0
	Provided By	LFA Machines

VFD parameters setting

9904	Vector speed
9905	Motor rated voltage
9906	Motor rated current
9907	Motor rated frequency
9908	Motor speed rating
9909	Motor rating
1001	D11 (Start the way)
1003	Positive rotation
1103	A12 (Select the external given signal source)
2101	automatic2 (Start the way)
2102	Free parking
2202	5 (To speed up the time)
2203	2 (Deceleration time)
1105	2000 (Maximum speed setting value)
2002	2000 (The highest speed)

 www.lfamachines.com	Drawing Name	FACF-1200 Wiring 16
	Product Name	FACF-1200
	Version	v1.0
	Provided By	LFA Machines

Resources

Helpful Links

Warranty

For information regarding the warranty policy of the FACP® range and other LFA products, please visit <https://www.lfacapsulefillers.com/warranty>

LFA Website

In order to aid you in your capsule production, LFA Machines maintains a website that offers a breadth of useful information about the FACP® range and other capsule fillers. You also have access to online tools such as the Capsule Size Chart and our regularly published articles that cover a whole range of topics about capsule fillers and capsule production.

Visit the LFA homepage at <https://www.lfacapsulefillers.com>

To create a free member's account, follow this link: <https://www.lfacapsulefillers.com/customer/account/create>

LFA Machines YouTube Channel

Our YouTube videos provide you an opportunity to see demonstrations of how to use our fully automatic capsule fillers, common troubleshooting tips, and other LFA capsule fillers and mixers. We regularly upload videos to give you a visual aid that will hopefully support you in your capsule production efforts. To watch our videos, visit <https://www.youtube.com/channel/UCwtbcwja77ai7vX2o34FUkQ>

LFA Machines Social Media

Social media is a great way to keep yourself updated on new developments and exciting things happening at LFA Machines. The list below contains our current social media pages:

Twitter: @lfatabletpress

Instagram: @lfatabletpresses

Facebook: <https://www.facebook.com/lfatabletpresses>

LinkedIn: <https://www.linkedin.com/company/lfamachines-oxford-ltd/>

Contact Us

UK

LFA Machines Oxford Ltd
Unit 4B Rowood Estate
Murdock Road
Bicester, Oxfordshire OX26 4PP
+44 01869 250234
support.uk@lfamachines.com
Monday-Friday
9AM-5PM GMT

USA

LFA Machines DFW, LLC
6601 Will Rogers Blvd
Fort Worth, TX 76140
+1 (682) 312 0034
support.usa@lfamachines.com
Monday-Friday
8AM-6PM UTC (Central)

Germany

LFA Machines Düsseldorf GmbH
Business Parc Am Trippelsberg 92
Düsseldorf, North-Rhine
Westphalia 40589
+41 21188250223
verkauf@lfamachines.com

Taiwan

LFA Machines Taiwan Ltd
7F-5, No. 2, Sec. 2 Taiwan Blvd
West District, Taichung City 403
Taiwan
+886 422031790
support.asia@lfamachines.com
Monday-Friday
9AM-5PM GMT+8



LFA MACHINES

Copyright © 2026 by LFA Machines

www.lfamachines.com

United Kingdom

Unit 4B
Murdock Road
Bicester
Oxfordshire
United Kingdom
OX26 4PP

United States

6601 Will Rogers Blvd
Fort Worth
Texas
United States
76140

Germany

Business Parc Am
Trippelsberg 92
Düsseldorf
Germany
40589

Taiwan

7F.-5, No. 2, Sec. 2
Taiwan Blvd., West Dist.,
Taichung City 403,
Taiwan