



CP 7000™ Capsule Polisher User Manual



We don't just sell machines—
we provide service.

Copyright Notice

© LFA Machines Oxford Limited, published in 2026 by LFA Machines Oxford Limited 2026. Registered in England and Wales, company number 08428898, registered office for service Demar House 14 Church Road East Wittering, Chichester, West Sussex, PO20 8PS.

All rights reserved. No part of this publication may be reproduced or transmitted, in any form or by any means, or stored in any retrieval system of any nature, without prior permission, except for fair dealing under the Copyright, Designs and Patents Act 1988, or in accordance with the terms of license issued by the Copyright Licensing Agency in respect of photocopying and/or reprographic reproduction. Application for permission for other use of the copyright material including permission to reproduce extracts in other published works shall be made to the publisher. Full acknowledgment or author, publisher and source must be given.

All trade marks are acknowledged and are owned by their respective owners.

Important Safety Information

READ THIS BEFORE OPERATING MACHINE

Intended Use

The intended use of this machine is to polish and remove dust and debris from capsules.

Potential misuse of this machine includes:

- Inserting anything other than hard capsules.
- Operating the machine without the soft brush or mesh.
- Operating the machine without a vacuum.

Personal Protection

For personal protection while transporting the CP 7000™, abide by these actions:

- Wear steel toe boots to prevent foot injury.
- Wear heavy duty grip gloves to ensure firm grasp on machine.
- Wear back support belt to prevent injury if needed.

For personal protection while operating the CP 7000™, abide by these actions:

- Avoid wearing loose jewelry to prevent machine entanglement.
- Contain long hair to prevent machine entanglement.
- Wear safety goggles.
- Wear disposable latex/rubber gloves.
- Wear a hairnet (food grade products only).
- Wear a beard net if needed (food grade products only).

General Hazards

- Be aware of risk of entanglement and pinch point due to moving parts.
- Do not operate in a wet environment or with wet hands due to risk of electrical shock or burn.
- Do not operate if any wires are damaged, pinched, or frayed due to risk of electrical shock or burn.
- Keep out of reach of children.
- Keep fingers away from all moving parts.
- Inspect machine before use.
- Check that nuts and bolts are suitably tightened.
- Use this machine only for its intended use as described in this manual.
- Turn off and unplug the machine before conducting cleaning and maintenance.
- Do not modify the machine in any way.

Safety Assessment

It is critical to conduct a safety assessment to ensure that it complies with all local laws and industry accepted safety regulations.

If you require guidance on the installation of the machine or conducting a safety assessment, please contact LFA Machines.

Important Safety Information

READ THIS BEFORE OPERATING MACHINE

Symbols



WARNING

This signals potential risk for personal injury.



CAUTION

This signals potential risk for damage to the machine or other parts.

Modes for Stopping

In the case of an emergency during operation, immediately turn off the main power (see below) and unplug.



Prop. 65 Statement for CA Residents

Based on LFA's current level of knowledge of our machines, the CP 7000™ does not require a Proposition 65 warning label.

Warning for Explosive Material

This machine is not explosion proof. LFA recommends that you test your materials' explosivity before running them through this machine. If your materials are indeed explosive, do not use them with this machine.

Table of Contents

Copyright Notice	2
Important Safety Information	3
Intended Use	3
Personal Protection	3
General Hazards	3
Safety Assessment	3
Symbols	4
Modes for Stopping	4
Prop. 65 Statement for CA Residents	4
Warning for Explosive Material	4
CP 7000™ Parts	6
Preface	7
Training	8
Off-Site Training	8
Training via Video Chat/Phone	8
LFA Articles	8
LFA Videos	8
Installation	9
Tools and Materials Needed	9
The Appropriate Workstation for the Machine	9
Positioning the CP 7000™	11
Assembly	11
Controls	13
Settings and Adjustment	18
Maintenance	20
General Maintenance Prescriptions	20
Lubrication	20
Repair and Replacement	22
Troubleshooting	23
Common Machine/Part Issues	23
Unsticking Capsules in the CP 7000™	24
Cleaning	26
Storing the CP 7000™	29
Appendix	29
Glossary	29
Description of CP 7000™ Parts	30
Material of Contact Parts	32
Technical Specifications	32
Maintenance Checklist	33
Resources	36

CP 7000™ Parts

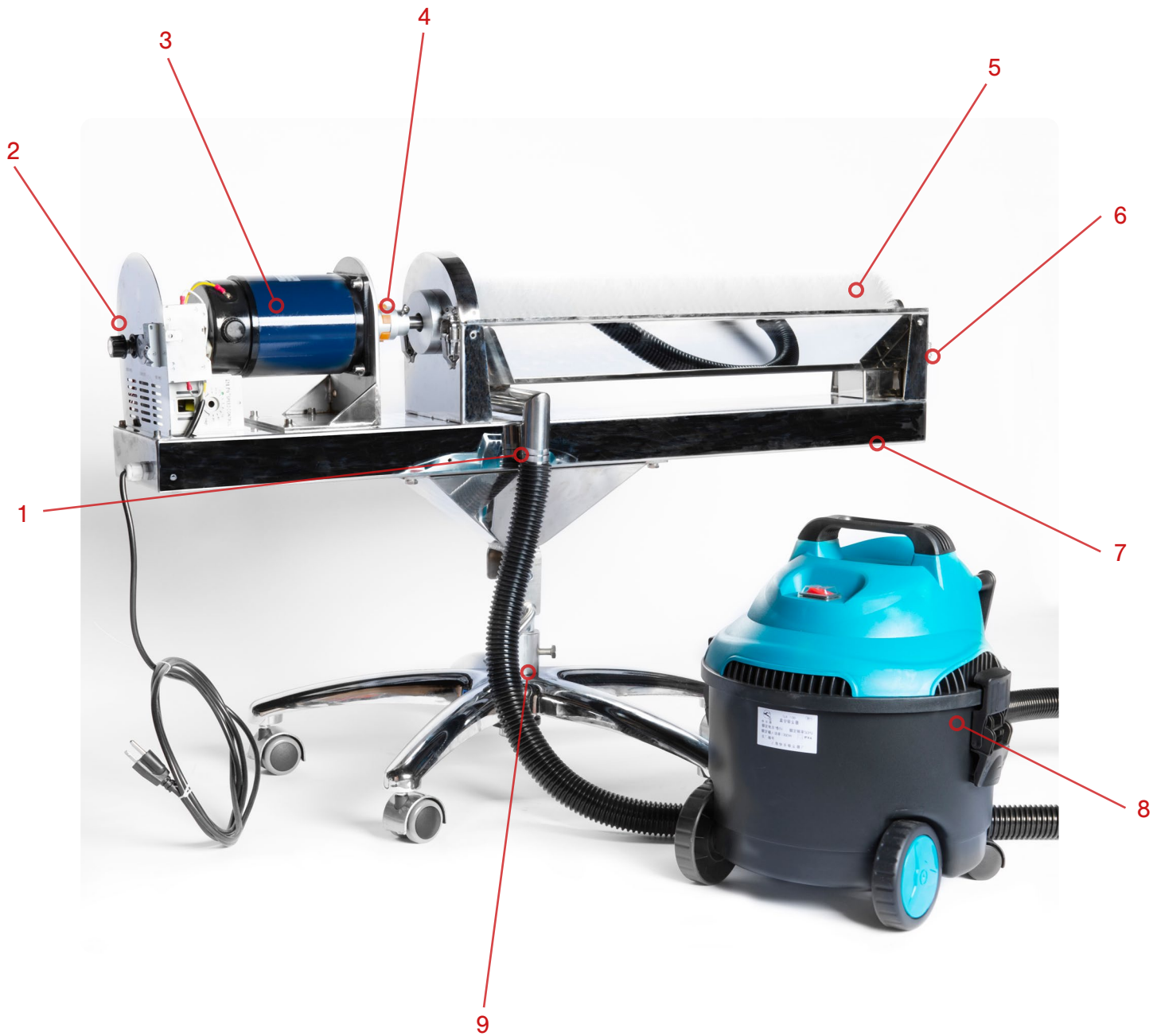

- 1. Vacuum Interface
- 2. Control Panel
- 3. Motor
- 4. Flexible Coupling
- 5. Brush (Mesh not pictured)
- 6. Drive Shaft

- 7. Discharge Chute
- 8. Vacuum
- 9. Stand

Preface



The CP 7000™ is a capsule polishing machine that works by using a soft brush to remove any dust or debris from the outside of filled capsules. When capsules are not polished, they can stick together and cause cross contamination, and the CP 7000™ prevents these issues from happening. With adjustable features such as polishing speed and machine stand height, this machine comes at an affordable price without compromising quality and has the ability to polish up to 7,000 capsules per minute. Made of stainless steel and easily movable, the CP 7000™ saves time and money by quickly and efficiently cleaning capsules.

The purpose of this document is to support your understanding of the CP 7000™'s components, features, functions, and design. With this manual, you will be able to successfully operate and maintain your CP 7000™ machine.

The user manual's content includes:

- Important safety information
- CP 7000™ installation instructions
- Description of the CP 7000™'s operation
- CP 7000™ maintenance information
- Appendix with supplemental information

Training

CP 7000™ training is essential for the machine's successful operation and your personal safety. There are several methods to prepare you for working with the CP 7000™.

Off-Site Training

LFA offers training at our UK, USA, and Taiwan facilities for all our customers and their teams. For more information, go to <https://www.lfacapsulefillers.com/services>

Training via Video Chat/Phone

Using an online video chat system, an LFA technician can interact face-to-face with you and assist with your understanding of the machine. Or, if you prefer, LFA can provide training via phone for all customers who call the office. To set up a training, call or email your local LFA office:

UK

Phone

+44 01869 250234

Email

support.uk@lfamachines.com

USA

Phone

+1 (682) 312-0034

Email

support.usa@lfamachines.com

Taiwan

Phone

+886 422031790

Email

support.asia@lfamachines.com

LFA Articles

LFA writes informative articles about our machines, which includes instructions, procedures, and guides. To access the articles, go to <https://www.lfacapsulefillers.com/articles>

LFA Videos

LFA has created videos involving our machines. To access the videos, go to <https://www.lfacapsulefillers.com/videos> or <https://www.youtube.com/user/TabletPilPress>

Installation

Tools and Materials Needed

Before you install and operate the CP 7000™, it is best to have the following tools and materials on hand for general operation and maintenance:

- Hammer
- Crowbar
- Rubber mallet
- Crosshead screwdriver
- Set of metric Allen keys with ball ends
- Lubricant (NSF approved for food grade products)
- Dry lubricant excipient such as magnesium stearate (purchase at <https://www.lfatabletpresses.com/magnesium-stearate>)
- Bagless vacuum
- Sanitizer (e.g. Member's Mark Commercial Sanitizer)
- Plastic sheet or something similar to cover machine
- Safety goggles
- Disposable latex/rubber gloves
- Hairnet and/or beard net (food grade products only)
- Sterile shoe covers (food grade products only)

The Appropriate Workstation for the Machine

Find stable, even flooring that supports the CP 7000™'s 40 kg (approximately 88 lbs) weight. This machine also has a single phase 110 V or 240 V ($\pm 10\%$) electrical requirement, so ensure that it is near an appropriate power plug.

Environmental Conditions

It is important that the environment in which you operate and store the CP 7000™ has the appropriate temperature and relative humidity levels. These two environmental factors can potentially cause the machine to rust and/or cause the capsules to have a lower quality. The table below shows the acceptable temperature and relative humidity levels:

Machine	Temperature		Humidity
CP 7000™	°C	°F	45-55% RH
	18-24	64-75	

The shipping crate will contain the following:

1. The CP 7000™



2. Stand

3. Vacuum and filter

4. Corrugated tube

5. Wheels

6. Hopper

Unpacking the CP 7000™

Tools Needed

- Hammer
- Crowbar

Instructions

1. Pry open the top panel of the shipping container with a hammer and crowbar.
2. Lift the top of the shipping container from its base.
3. Remove the plastic wrapping.

3.1 Note: Save the wrapping for future transport and/or storage.

Positioning the CP 7000™

WARNING: To prevent personal injury, wear steel toe boots and heavy duty grip gloves while transporting the CP 7000™.



One or two people should be sufficient in removing the machine from the shipping container and positioning it in the workspace.

To safely transport the CP 7000™, wrap the machine with a lifting strap and secure it to the engine hoist or lift.

Assembly

The CP 7000™ comes fully assembled with a few minor installations.

Tools Needed

- Vacuum and filter
- Corrugated tube
- Stand
- Wheels
- Rubber mallet
- Hopper

Instructions

1. Insert the wheels into the bottom of the stand.
 - 1.1 Note: Use a rubber mallet to aid in inserting the wheels.
2. Remove the bolt and nut on the stand.
3. Insert the connector through the bottom of the stand.
4. Secure the nut underneath the bottom of the stand and on the connector.

5. Raise the CP 7000™ above the stand and wheels.
6. Insert the CP 7000™ into the bottom of the stand and the connector.
7. Resecure the bolt onto the stand and the CP 7000™.



8. Place the vacuum inside the cover and filter.
9. Connect the corrugated tube to the CP 7000™ and the vacuum.



10. Insert the Hopper into the machine.



11. Plug in the machine and vacuum.

Controls

Basic Components



A description of the principal components follows:

- The **Hopper** contains the capsules that will be polished and funnels them into the machine.
- The **Brush** gently removes dust and debris from the filled capsules' outside.
- The **Mesh** acts a sieve against the capsules and the brush and allows the dust and debris to pass through the machine.
- The **Vacuum** collects the excess dust and debris removed by the brush.

Control Panel



1. Adjusts operation speed
2. Starts/stops machine operation

3. Power on/off machine

CP 7000™ Process

The basic mechanism of the CP 7000™ involves the brush cleaning the filled capsules and the vacuum removing the excess debris from the machine.

Polishing the Filled Capsules

Once the machine and vacuum are plugged in and turned on, the brush inside of the mesh begins to move. After the capsules are poured in the Hopper, they are then cleaned and polished by the brush.

Collecting Capsule Dust and Debris

The capsule dust and debris pass through the mesh. The vacuum then sucks and collects the excess material.

Discharging the Polished Capsules

Once the capsules have gone through the brush, they are discharged via a chute.

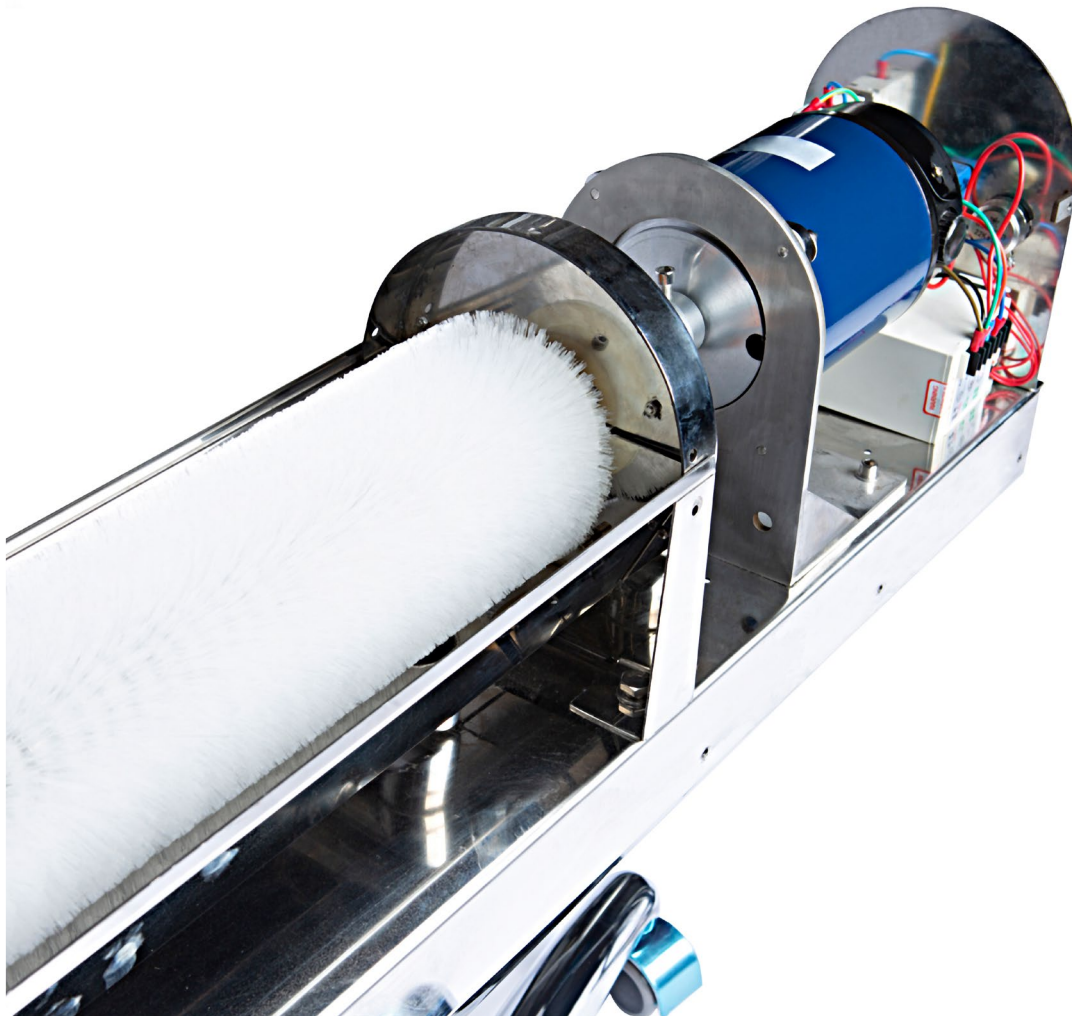

How to Polish Capsules with the CP 7000™

Tools and Materials Needed

- Filled capsules
- CP 7000™ with vacuum
- Receptacle to catch polished capsules
- Safety goggles
- Disposable latex/rubber gloves (for food grade products and to protect hands from grease)
- Hairnet and/or beard net (food grade products only)
- Sterile shoe covers (food grade products only)



WARNING: For personal protection while operating the CP 7000™, contain long hair and do not wear loose jewelry.

Instructions

Note: Wear latex/rubber gloves (and appropriate food grade attire if applicable) during this process.

1. Turn on the vacuum.



2. Place the receptacle to catch polished capsules underneath the Discharge Chute.



3. Flip the main power switch on.
4. Press the start/stop button to begin machine operation.



Settings and Adjustment

Operation Speed

The CP 7000™ operation speed can be adjusted by turning a dial on the control panel. Be sure to not increase the brush speed too much, as this could cause damage to the capsules.

Tools and Materials Needed

- Safety goggles
- Disposable latex/rubber gloves (for food grade products and to protect hands from grease)
- Hairnet and/or beard net (food grade products only)
- Sterile shoe covers (food grade products only)



WARNING: For personal protection while operating and adjusting the CP 7000™, contain long hair and do not wear loose jewelry.

Instructions

Note: Wear latex/rubber gloves (and appropriate food grade attire if applicable).

1. Flip the main power switch on.
2. Press the start/stop button to begin machine operation.
3. Rotate the dial to increase/decrease the brush operation speed.



Capsule Polisher Pitch Position

Adjusting the capsule polisher's pitch can ensure an optimal cleaning performance from the machine. Decreasing the pitch makes the capsule polisher flat, and increasing it makes it steeper so that the capsules fall back into the brush.

Tools and Materials Needed

- Safety goggles
- Disposable latex/rubber gloves (for food grade products and to protect hands from grease)
- Hairnet and/or beard net (food grade products only)
- Sterile shoe covers (food grade products only)



WARNING: Always unplug this machine when adjusting the stand's position.

Instructions

Note: Wear latex/rubber gloves (and appropriate food grade attire if applicable) during this process.

1. Pull the pitch adjustment lever clockwise.



2. Adjust the capsule polisher until it is at the desired position.
3. Pull the pitch adjustment lever counterclockwise to lock the capsule polisher's position in place.

Maintenance

To ensure that the CP 7000™ will have a long operational life, maintenance is essential. This section includes methods for troubleshooting solutions and how often to clean your machine to keep its performance optimal.

General Maintenance Prescriptions

- Use the maintenance checklist (found in the Appendix) before, during, and after machine operation.
- Unplug the machine before cleaning.
- Make sure all grease points are maintained and regularly lubricated.
- Use an appropriate amount of lubricant.
- Before reassembling the machine after cleaning, make sure that the parts are dried.
- Constantly check for any loose nuts and/or screws before, during, and after machine operation.

Lubrication

Regularly greasing your machine is vital to prolonging its operational life. Parts that are not greased properly can make the machine seize up and cause major problems later. LFA recommends maintaining a lubrication schedule for your CP 7000™, which can be found in this section.

Tools and Materials Needed

- Lubricant/grease (food grade if machine has contact with the food or drug product)
- Crosshead screwdriver
- Disposable latex/rubber gloves (for food grade products and to protect hands from grease)
- Hairnet and/or beard net (food grade products only)
- Sterile shoe covers (food grade products only)



WARNING: To prevent any potential personal injury, unplug the CP 7000™ from the electrical outlet.

Instructions

Note: Wear latex/rubber gloves (and appropriate food grade attire if applicable) during this process.

1. Remove the Hopper from the machine.
2. Loosen the brush's cover with a crosshead screwdriver, unbuckle the fasteners, and remove the cover from the machine.

3. Apply grease to the two bearings on either side of the machine's drive shaft.

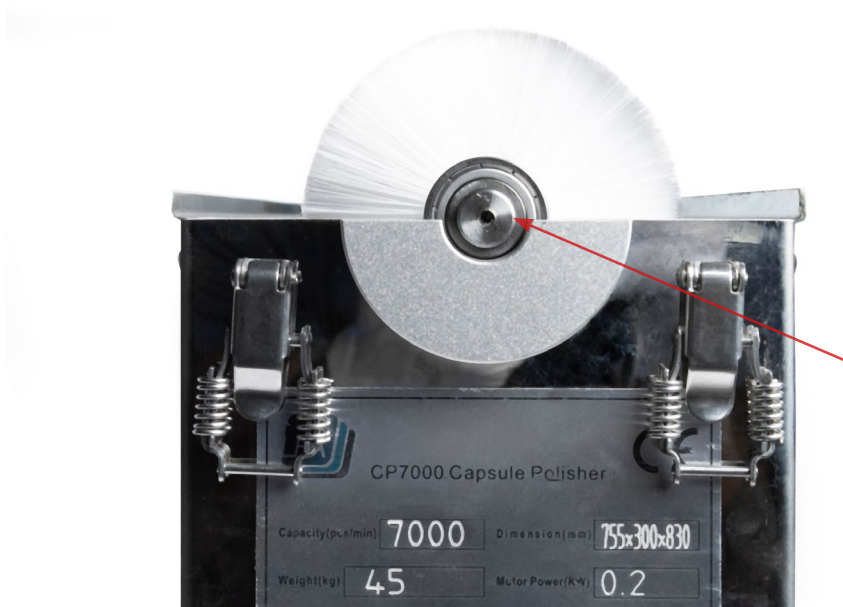

Lubrication Schedule

LFA recommends the following CP 7000™ parts to be lubricated according to the following frequency:

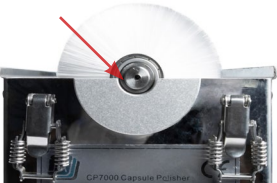
Part	Location	Image	Frequency	Type of Lubricant
Bearings on brush drive shaft	On both ends of the brush drive shaft		Every 100 hours/once per week	NLGI Grade 2

Repair and Replacement

Some parts of the CP 7000™ may need to be removed for repair and replacement.

Warranty

To access LFA's warranty policy, go to <https://www.lfacapsulefillers.com/warranty>

If your part is eligible for warranty, have your part's serial number on hand and please contact LFA:

UK

Phone

+44 01869 250234

Email

support.uk@lfamachines.com

USA

Phone

+1 (682) 312-0309

Email

support.usa@lfamachines.com

Taiwan

Phone

+886 422031790

Email

support.asia@lfamachines.com

Troubleshooting

Sometimes unavoidable issues will occur while operating the CP 7000™. Fortunately, there are several methods to remedy these issues.

Common Machine/Part Issues

Symptom	Possible Cause	Possible Solution
The polishing speed is slow	The brush is damaged.	Look for damage on the brush and replace if necessary.
Loud noise is coming from the machine's polishing section	The brush/shaft is loose.	Resecure the brush and the mesh.
There is dust and debris on the brush and the mesh	The vacuum is not working properly.	Check that the corrugated hose has a good connection between the vacuum and the machine.
		Check the vacuum's power and ensure that it works.
	The vacuum filter is dirty.	Clean the filter or purchase a new one.
Capsules are not being thoroughly polished	The brush is seriously worn.	Replace the brush.
	Capsules are sticking together.	Cover the inside of the mesh and the brush with a dry lubricant such as magnesium stearate.
		Use anti-static tools when handling the capsules.
		Slightly raise the relative humidity (no higher than 55%).
	Too many capsules are inside the machine during operation.	Reduce the amount of capsules to be polished.
The brush is dirty and covered with debris.	Regularly clean the brush.	

Unsticking Capsules in the CP 7000™

Due to the electrostaticity of capsules, they may have a tendency to become stuck together. Fortunately, there are a couple of solutions to this issue.

Tools and Materials Needed

- Crosshead screwdriver
- Dry lubricant excipient such as magnesium stearate (purchase at <https://www.lfatabletpresses.com/magnesium-stearate>)
- Disposable latex/rubber gloves (for food grade products and to protect hands from grease)
- Hairnet and/or beard net (food grade products only)
- Sterile shoe covers (food grade products only)



WARNING: To prevent any potential personal injury, ALWAYS unplug the CP 7000™ before removing stuck capsules.

Instructions

Note: Wear latex/rubber gloves (and appropriate food grade attire if applicable) during this process.

Coat Brush and Mesh with Dry Lubricant

1. Remove the Hopper from the machine.
2. Loosen the brush's cover with a crosshead screwdriver, unbuckle the fasteners, and remove the cover from the machine.
3. Remove the mesh from the brush.



4. Lightly coat the brush and mesh with a dry lubricant such as magnesium stearate.
5. Place the mesh over the brush.
6. Resecure the brush's cover with a crosshead screwdriver.
7. Reinsert the Hopper into the machine.

Handle the Capsules with Anti-Static Tools

Using anti-static materials such as vinyl food grade gloves and polypropylene plastic scoops will aid in preventing capsules from sticking together.



Slightly Increase the Humidity

Moisture in the air prevents static electricity, so increasing the humidity levels in the working environment can help prevent capsules sticking together. Do NOT place capsules in an environment with a relative humidity higher than 55%.

Cleaning

During the CP 7000™'s operation, excess powder will find its way into parts of the machine. It is important to clean the CP 7000™ thoroughly to prevent rusting and cross contamination.

LFA recommends that the machine be cleaned after each operation.

Tools and Materials Needed

- Crosshead screwdriver
- Set of metric Allen keys with ball ends
- Cleaning brush
- Toothbrush
- Disposable latex/rubber gloves
- Bagless vacuum
- Clean cloths
- Potable water
- Bowl of warm soapy water (nothing abrasive)
- Sanitizer (e.g. Member's Mark Commercial Sanitizer)
- Hairnet and/or beard net (food grade products only)
- Safety goggles
- Sterile shoe covers (food grade products only)



WARNING: To prevent any potential personal injury, ALWAYS unplug the CP 7000™ from the electrical outlet when replacing parts.

Instructions

Note: Wear safety goggles and latex/rubber gloves (and appropriate food grade attire if applicable) during this process.

Remove the Machine Parts

1. Remove the Hopper from the machine.
2. Loosen the both of the machine's covers with a crosshead screwdriver.
3. Unfasten the four buckles and remove the covers from the machine.



4. Remove the mesh from the brush.
5. Disengage and pull out the brush from machine.



Clean the Machine and its Parts

6. Vacuum inside the machine and remove any excess powder.
7. Wash the mesh and brush with a clean cloth and soapy water.
 - 7.1 Note: Use the toothbrush for difficult-to-remove debris.
8. Dry the mesh and brush immediately after they are cleaned and rinsed.
9. Sanitize the mesh and brush with a clean cloth.
10. Pull up the vacuum from the cover and remove the filter.
11. Submerge the vacuum filter in the bowl of warm soapy water and rub off all the dust and debris.
12. Rinse the vacuum filter and allow it to air dry before placing it back into the vacuum's cover.

Cleaning Schedule Matrix

Part	Frequency							
	After installing machine	After every use	Before every use	In between products that present a cross contamination risk	Weekly	Monthly	Before placing in storage	After removing from storage
Hopper	Remove from machine	Remove from machine	Remove from machine	Remove from machine	Remove from machine	Remove from machine	Remove from machine	Remove from machine
Covers	Remove from machine	Remove from machine	Remove from machine	Remove from machine	Remove from machine	Remove from machine	Remove from machine	Remove from machine
Sifter (inside machine)	Remove from machine	Remove from machine	Remove from machine	Remove from machine	Remove from machine	Remove from machine	Remove from machine	Remove from machine
Corrugated Tube (if using)	Remove from machine	Remove from machine	Remove from machine	Remove from machine	Remove from machine	Remove from machine	Remove from machine	Remove from machine
Feeder/Discharge Chute	Clean on machine	Remove from machine	Remove from machine	Remove from machine	Remove from machine	Remove from machine	Remove from machine	Remove from machine

Cleaning Level Key	
Level 1 - Remove powder	
Level 2 - Dry clean with cloth	
Level 3 - Dry clean and re-lubricate if specified in lubrication schedule	
Level 4 - Wet clean and re-lubricate if specified in lubrication schedule	
Remove from machine - Take part out of machine and clean if required. Store it correctly or install back into machine.	
Install into machine - Install part into the machine and make sure that it has been cleaned. If needed, lubricate to the level required.	
Clean on/in machine - Clean the part while in the machine and do not remove it. Make sure that all contact surfaces are clean to the level required.	

This cleaning matrix is intended as a guide only and is not an exhaustive list. All cleaning schedules will need to be adapted to the industry and product, following industry regulations and the material safety data sheets that come with specific products. Please check with your Food Safety Manager/Department, Quality Control Manager/Department, or other relevant internal departments at your company before using.

Storing the CP 7000™

After its thorough cleaning, the CP 7000™ needs to be stored in the proper conditions. It is important to store it in an environment in which the machine is safe from rusting.

Tools and Materials Needed

- Plastic wrapping to cover machine
- Disposable latex/rubber gloves (for food grade products and to protect hands from lubricant)
- Hairnet and/or beard net (food grade products only)
- Sterile shoe covers (food grade products only)

Instructions

Note: Wear latex/rubber gloves (and appropriate food grade attire if applicable) during this process.

Cover the CP 7000™

1. Carefully cover the CP 7000™ with the plastic wrapping.
 - 1.1 Note: You can use the plastic wrapping that came with the machine in the shipping container.

Environmental Conditions

It is important that the environment in which you operate and store the CP 7000™ has the appropriate temperature and relative humidity levels. These two environmental factors can potentially cause the machine to rust and/or cause the capsules to have a lower quality. The table below shows the acceptable temperature and relative humidity levels:

Machine	Temperature		Humidity
CP 7000™	°C	°F	45-55% RH
	18-24	64-75	

Appendix

Glossary

Term	Definition
API/Active Pharmaceutical Ingredient	Any substance or mixture of substances used that is an active ingredient in the drug product.
Excipient	An inactive substance that serves as the vehicle or medium for a drug or other API.
Formulation	Powder mix of the excipient and the API that is used to fill capsules.
Megapascal (MPa)	The measure of force per unit area and defined as one newton per square meter.

Description of CP 7000™ Parts

Brush

The brush rotates inside the capsule polisher and removes debris from the filled capsules, resulting in their polishing.



Capsule Polisher Vacuum Filter

The vacuum filter aids in the dust and debris collection from the polished capsules. It is located inside of the vacuum cover.



On/Off Button

The On/Off button is pressed to start or stop machine operation.



Mesh

The mesh covers the brush and sieves the excess dust and debris from the capsules.

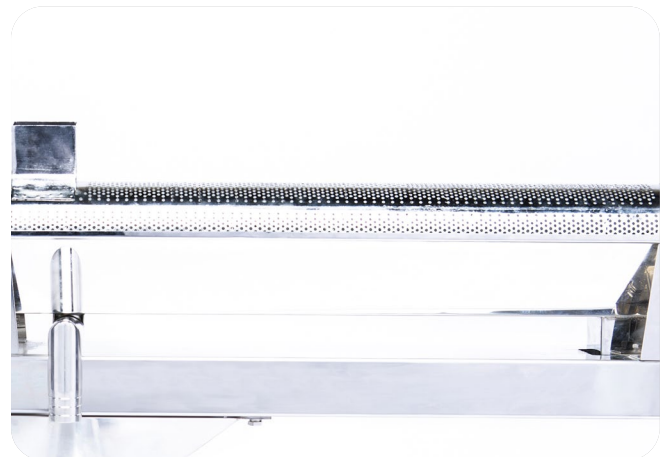

Cover

The cover comprises of two parts, with one enclosing the mesh and brush and the other the motor and electrics.

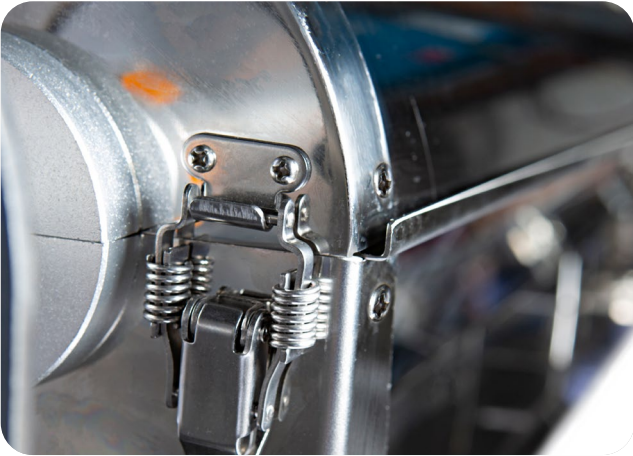

Hopper

The Hopper contains the capsules that will be polished and funnels them into the machine.



Motor

The Motor is located inside the cover and powers the capsule polisher's operation.



Material of Contact Parts

Contact Part	Material
Hopper	304 SS
Mesh	304 SS
Discharge Chute	304 SS
Brush	DuPont Nylon 1010

Technical Specifications

Ouput/min	7,000 capsules
Power US	110 V, 0.18 kW, single phase, 60 Hz
Power UK	240 V, 0.18 kW, single phase, 50 Hz
Dimensions (mm)	1160 X 360 X 780
Maximum working space suggested for machine (mm)	1925 X 1450 X 1800
Weight	40 kg / 88 lbs
Vacuum air pressure	2.7 m ³ , -0.014 MPa

Maintenance Checklist

Before Operation	
<input type="checkbox"/>	Visually inspect the capsule polisher and the parts.
<input type="checkbox"/>	Ensure that all bolts, screws, and fasteners are secured.
<input type="checkbox"/>	Ensure that all wires are connected and that a proper electrical outlet is nearby (single phase 110 V or 240 V [$\pm 10\%$]).
<input type="checkbox"/>	If to be used in conjunction with capsule filler, the CP 7000™ Feeder must be near the Discharge Chute of the capsule filler.
<input type="checkbox"/>	Ensure the piping and connectors are properly installed.
<input type="checkbox"/>	Conduct a test run for the machine with a few capsules and slowly adjust the operation speed. Watch out for any abnormalities such as excess noise or vibration.
During Operation	
<input type="checkbox"/>	During a regular run, listen for irregular knocking or clicking sounds. If heard, stop operation and investigate the source of the sound.
<input type="checkbox"/>	Watch for capsules sticking together due to static electricity. For further help go to page 24.
<input type="checkbox"/>	If needed, adjust the capsule polisher stand's position.
<input type="checkbox"/>	Inspect the polished capsules for any damage once they come out from the machine.
After Operation	
<input type="checkbox"/>	Unplug machine and remove all excess powder with a bagless vacuum.
<input type="checkbox"/>	Open the covers and clean the inside of the machine (e.g. mesh, brush, etc.).
<input type="checkbox"/>	Wipe down the other surfaces with a damp cloth.

CP 7000™ Dimensions Drawing

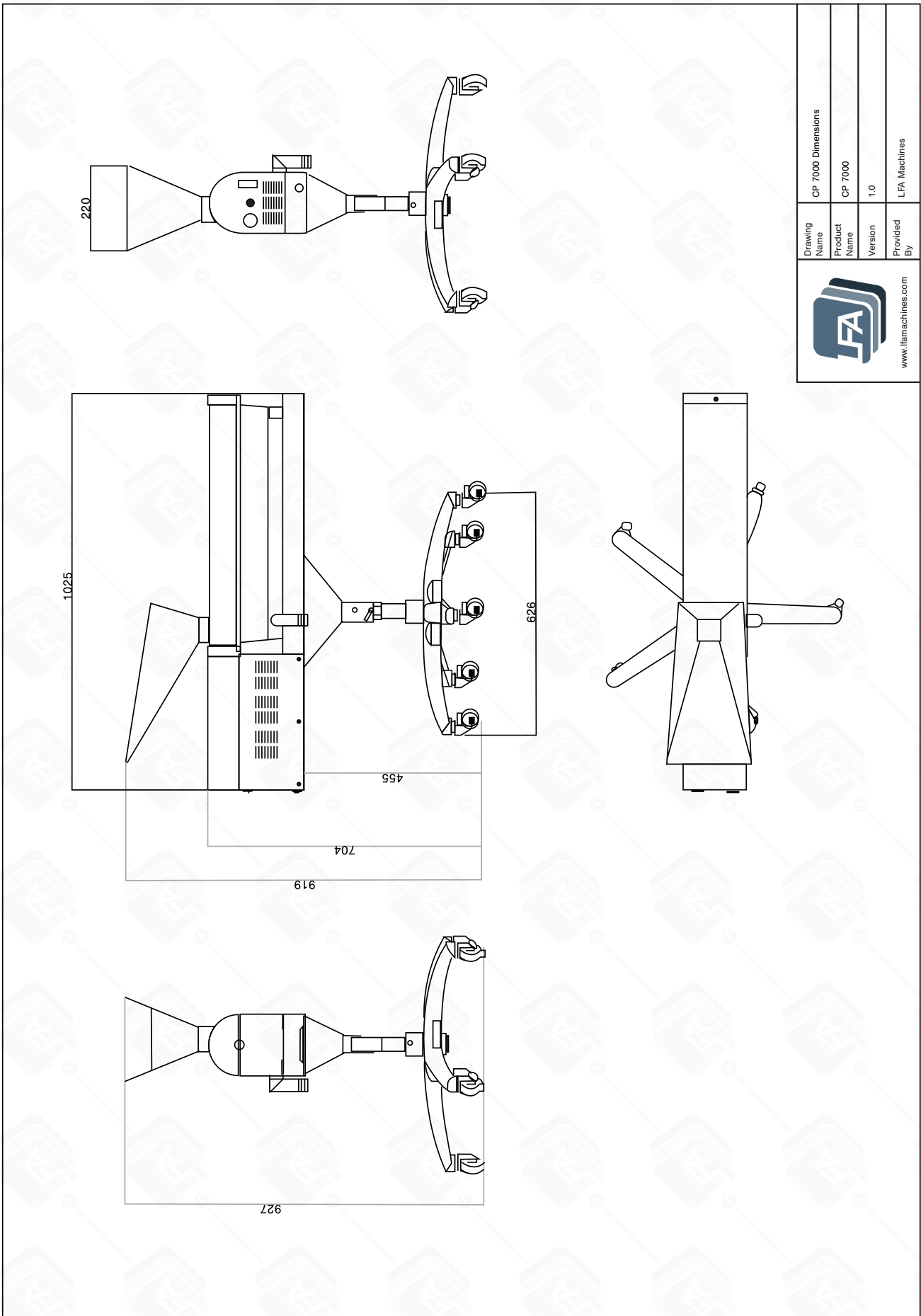

 www.lfamachines.com	Drawing Name	CP 7000 Dimensions
	Product Name	CP 7000
	Version	1.0
Provided By		LFA Machines

CP 7000™ Electrical Drawing

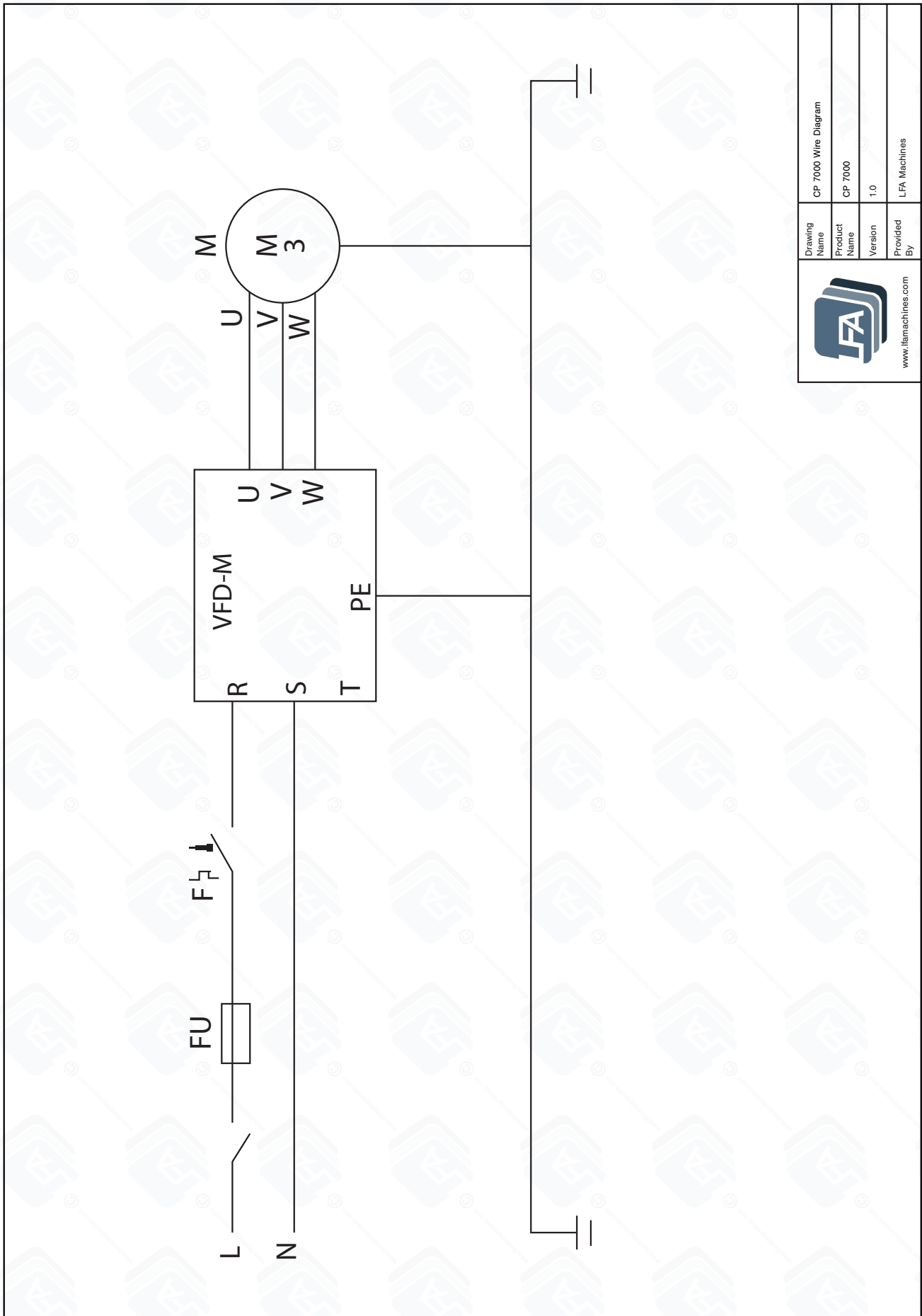

 www.lfamachines.com	Drawing Name	CP 7000 Wire Diagram
	Product Name	CP 7000
	Version	1.0
Provided By	LFA Machines	

Resources

Helpful Links

Warranty

For information regarding the warranty policy of the CP 7000™ and other LFA products, please visit <https://www.lfacapsulefillers.com/warranty>

LFA Website

In order to aid you in your capsule production, LFA Machines maintains a website that offers a breadth of useful information about the capsule polisher and capsule fillers. You also have access to online tools such as the Capsule Size Chart and our regularly published articles that cover a whole range of topics about capsule fillers and capsule production.

Visit the LFA homepage at <https://www.lfacapsulefillers.com/>

LFA Machines YouTube Channel

Our YouTube videos provide you an opportunity to see how to use our machines, common troubleshooting tips, and other LFA products such as capsule fillers and mixers. We regularly upload videos to give you a visual aid that will hopefully support you in your capsule production efforts. To watch our videos, visit <https://www.youtube.com/channel/UCwtbcwja77ai7vX2o34FUkQ>

LFA Machines Social Media

Social media is a great way to keep yourself updated on new developments and exciting things happening at LFA Machines. The list below contains our current social media pages:

Twitter: @lfatabletpress

Facebook: <https://www.facebook.com/lfatabletpresses>

LinkedIn: <https://www.linkedin.com/company/lfa-machines-oxford-ltd/>

Contact Us

UK

LFA Machines Oxford Ltd
Unit 4B Rowood Estate
Murdock Road
Bicester, Oxfordshire OX26 4PP
+44 01869 250234
support.uk@lfamachines.com
Monday-Friday
9AM-5PM GMT

USA

LFA Machines DFW, LLC
6601 Will Rogers Blvd
Fort Worth, TX 76140
+1 (682) 312 0034
support.usa@lfamachines.com
Monday-Friday
8AM-6PM UTC (Central)

Germany

LFA Machines Düsseldorf GmbH
Business Parc Am Trippelsberg 92
Düsseldorf, North-Rhine
Westphalia 40589
+41 21188250223
verkauf@lfamachines.com

Taiwan

LFA Machines Taiwan Ltd
7F-5, No. 2, Sec. 2 Taiwan Blvd
West District, Taichung City 403
Taiwan
+886 422031790
support.asia@lfamachines.com
Monday-Friday
9AM-5PM GMT+8



LFA MACHINES

Copyright © 2026 by LFA Machines

www.lfamachines.com

United Kingdom

Unit 4B
Murdock Road
Bicester
Oxfordshire
United Kingdom
OX26 4PP

United States

6601 Will Rogers Blvd
Fort Worth
Texas
United States
76140

Germany

Business Parc Am
Trippelsberg 92
Düsseldorf
Germany
40589

Taiwan

7F.-5, No. 2, Sec. 2
Taiwan Blvd., West Dist.,
Taichung City 403,
Taiwan